

Maintenance and Troubleshooting Guide



1 Performing
Calibration and
Verification Runs



2 Maintaining the
7900HT
Instrument
Hardware



3 Maintaining the
Computer and
Software



4 Maintaining the
Automation
Accessory



5 Troubleshooting
Chemistry and
Assay Runs



6 Flags and Filtering

© Copyright 2007, 2010 Applied Biosystems. All rights reserved.

For Research Use Only. Not for use in diagnostic procedures.

Notice to Purchaser

The Applied Biosystems 7900HT Fast Real-Time PCR System is a real-time thermal cycler covered by US patents and corresponding claims in their non-US counterparts, owned by Applied Biosystems. No right is conveyed expressly, by implication or by estoppel under any other patent claim, such as claims to apparatus, reagents, kits, or methods such as 5' nuclease methods. Further information on purchasing licenses may be obtained by contacting the Director of Licensing, Applied Biosystems, 850 Lincoln Centre Drive, Foster City, California 94404, USA.

TRADEMARKS:

ABI PRISM, Applied Biosystems, MicroAmp, and VIC are registered trademarks and AB (Design), Applera, FAM, JOE, NED, ROX, TAMRA, and TET are trademarks of Applied Biosystems or its subsidiaries in the U.S. and/or certain other countries.

GeneAmp and TaqMan are registered trademarks of Roche Molecular Systems, Inc.

SYBR is a registered trademark of Molecular Probes, Inc.

Zymark is a registered trademark of Zymark Corporation.

Windows is a registered trademark of Microsoft Corporation.

All other trademarks are the sole property of their respective owners.

Part Number 4365542 Rev. C
06/2010

Contents

	Preface	v
	How to Use This Guide	v
	How to Obtain More Information	vi
	How to Obtain Support	vii
Chapter 1	Performing Calibration and Verification Runs	1
	Recommended Run Schedule	2
	Performing a Background Calibration	3
	Performing a Pure Dye Calibration	17
	Performing an Instrument Verification Run	32
Chapter 2	Maintaining the 7900HT Instrument Hardware	51
	Recommended Maintenance Schedule	52
	Removing and Installing a Sample Block	53
	Replacing the Plate Adapter	62
	Decontaminating the Sample Block	65
Chapter 3	Maintaining the Computer and Software	71
	Recommended Maintenance Schedule	72
	Archiving and Backing Up SDS Software Files	73
	Defragmenting the Hard Drive	76
	Managing Local User Accounts in the SDS Software	78
	Updating the SDS Software	83
	Updating the Operating System Software	83
	Troubleshooting Software and Computer Problems	84
Chapter 4	Maintaining the Automation Accessory	87
	Recommended Maintenance Schedule	88
	Automation Accessory Components and Stack Positions	89
	Cleaning and Replacing Gripper Finger Pads	90
	Adjusting the Plate Sensor Switch	92
	Aligning the Plate Handler	97

	Aligning the Fixed-Position Bar Code Reader	110
	Troubleshooting the Automation Accessory	117
Chapter 5	Troubleshooting Chemistry and Assay Runs	119
	Low Precision or Irreproducibility	120
	Standard Curve (AQ) and Comparative CT (RQ) Quantitative Assay Runs	124
	Allelic Discrimination and Plus/Minus End-Point Assay Runs	126
Chapter 6	Flags and Filtering	127
	Using Flags	128
	Flags By Analysis	130
	Description of Flags	132
Appendix A	Adding Custom Dyes to the Pure Dye Set	141
	Before You Begin	141
	Creating a Dilution Series Plate	144
	Creating a Plate Document for the Dilution Series Plate	144
	Running and Analyzing the Dilution Series Plate	145
	Creating a Pure Dye Plate with the Custom Dye(s)	148
	Adding the New Custom Dye(s) to the SDS Software	149
	Creating a Plate Document Template with the Custom Dye(s)	150
Appendix B	Instrument Connections	153
Appendix C	Parts and Consumables	157
	Interchangeable Sample Block Modules and Accessories	157
	Consumables and Disposables	158
	Instrument Maintenance and Verification	160
	Index	163

How to Use This Guide

Purpose of This Guide This guide provides recommended schedules and procedures for maintaining the Applied Biosystems 7900HT Fast Real-Time PCR System (7900HT Fast System). This guide also includes troubleshooting information for the maintenance procedures.

Audience This guide is intended for:

- Personnel who maintain the 7900HT Fast System hardware
- System Administrators who maintain the 7900HT Fast System software
- Personnel running experiments

Assumptions For hardware maintenance, this guide assumes that you have:

- Familiarity with the Microsoft Windows® XP operating system.
- Knowledge of general techniques for handling DNA samples and preparing them for PCR.

For software maintenance, this guide assumes that you have:

- Familiarity with the Microsoft Windows® XP operating system.
- A general understanding of hard drives and data storage, file transfers, and copying and pasting.
- Networking experience, if you want to integrate the 7900HT Fast System into your existing laboratory data flow

Text Conventions This guide uses the following conventions:

- **Bold** indicates user action. For example:
Type **0**, then press **Enter** for each of the remaining fields.
- *Italic* text indicates new or important words and is also used for emphasis. For example:
Before analyzing, *always* prepare fresh matrix.
- A right arrow bracket (>) separates successive commands you select from a drop-down or shortcut menu. For example:
Select **File > Open**.

User Attention Words The following user attention words appear in Applied Biosystems user documentation. Each word implies a particular level of observation or action as described below:

Note – Provides information that may be of interest or help but is not critical to the use of the product.

IMPORTANT! – Provides information that is necessary for proper instrument operation, accurate chemistry kit use, or safe use of a chemical.

 **CAUTION** Indicates a potentially hazardous situation that, if not avoided, may result in minor or moderate injury. It may also be used to alert against unsafe practices.

 **WARNING** Indicates a potentially hazardous situation that, if not avoided, could result in death or serious injury.

Safety Follow specific safety practices when using this instrument. For safety guidelines, refer to the “Safety and EMC Compliance” section in the *Applied Biosystems 7900HT Fast Real-Time PCR System Site Preparation Guide* (PN 4351923).

For any chemical manufactured or distributed by Applied Biosystems, you can obtain the MSDS from Applied Biosystems. This service is available free 24 hours a day. To obtain MSDSs:

1. Go to www.appliedbiosystems.com, click **Support**, then click **MSDS Search**.
2. In the Keyword Search field, enter the chemical name, product name, MSDS part number, or other information that appears in the MSDS of interest. Select the language of your choice, then click **Search**.
3. Find the document of interest, right-click the document title, then select any of the following:
 - **Open** – To view the document
 - **Print Target** – To print the document
 - **Save Target As** – To download a PDF version of the document to a destination that you choose

For the MSDSs of chemicals not distributed by Applied Biosystems, contact the chemical manufacturer.

How to Obtain More Information

Related Documentation

For more information about using the 7900HT Fast System, refer to:

- *Sequence Detection Systems Software version 2.3 Online Help (SDS Online Help)*
- *Applied Biosystems 7900HT Fast Real-Time PCR System Site Preparation Guide* (PN 4351923)
- *Applied Biosystems 7900HT Fast Real-Time PCR System Allelic Discrimination Getting Started Guide* (PN 4364015)
- *Applied Biosystems 7900HT Fast Real-Time PCR System Absolute Quantitation Using Standard Curve Getting Started Guide* (PN 4364014)
- *Applied Biosystems 7900HT Fast Real-Time PCR System Plus-Minus Getting Started Guide* (PN 4364017)
- *Applied Biosystems 7900HT Fast Real-Time PCR System Relative Quantitation Using Comparative C_T Getting Started Guide* (PN 4364016)
- *Real-Time PCR Systems Chemistry Guide* (PN 4348358)

- *SDS Enterprise Database for the Applied Biosystems 7900HT Fast Real-Time PCR System Administrators Guide* (PN 4351669)
- *TaqMan[®] Low Density Array Getting Started Guide* (PN 4319399)

Send Us Your Comments

Applied Biosystems welcomes your comments and suggestions for improving its user documents. You can e-mail your comments to:

techpubs@appliedbiosystems.com

How to Obtain Support

To contact Applied Biosystems Technical Support from North America by telephone, call **1.800.762.4001**.

For the latest services and support information for all locations, go to <http://www.appliedbiosystems.com>, then click the link for **Support**.

At the Support page, you can:

- Obtain worldwide telephone and fax numbers to contact Applied Biosystems Technical Support and Sales facilities
- Search through frequently asked questions (FAQs)
- Submit a question directly to Technical Support
- Order Applied Biosystems user documents, MSDSs, certificates of analysis, and other related documents
- Download PDF documents
- Obtain information about customer training
- Download software updates and patches

1

Performing Calibration and Verification Runs

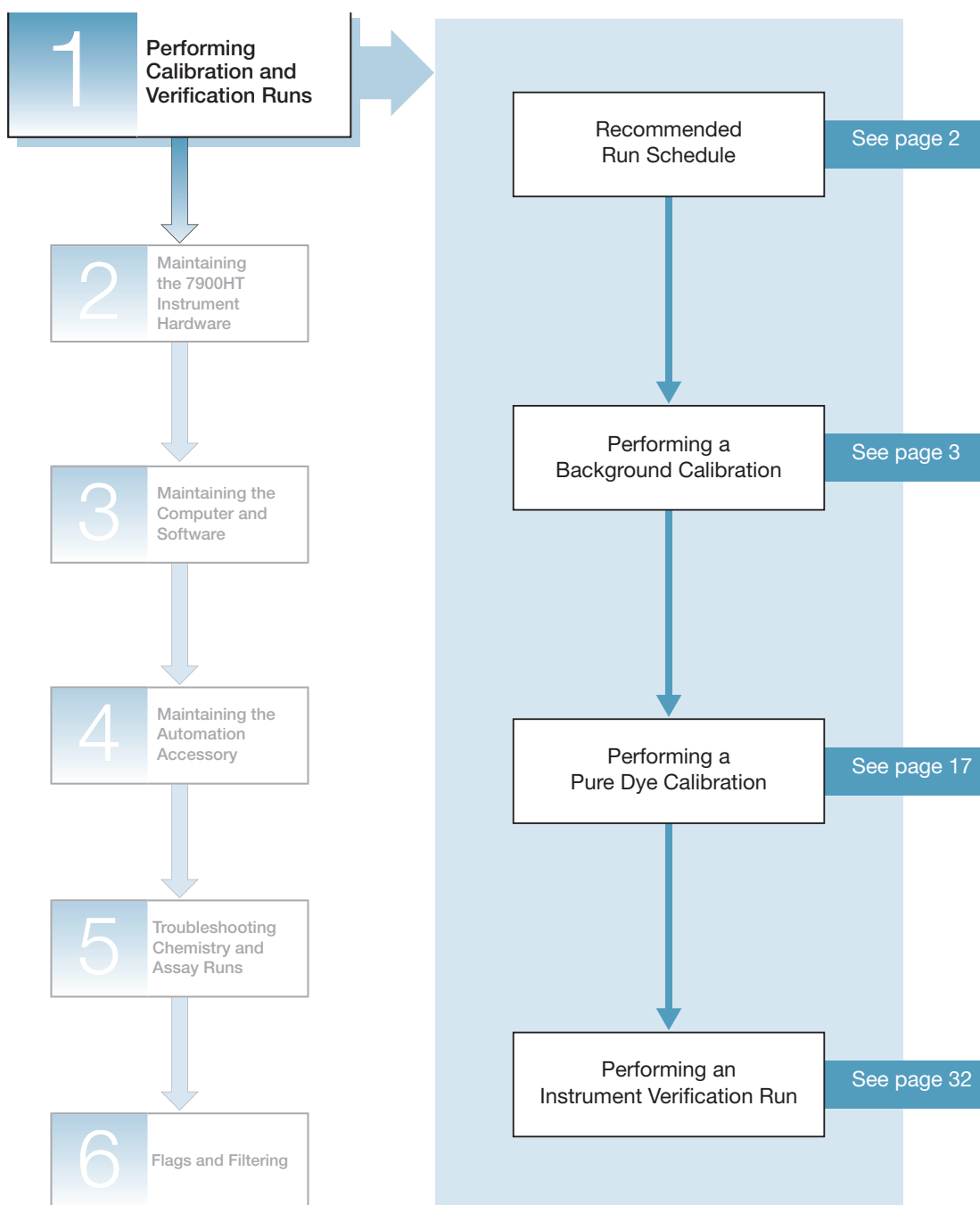

Notes

Recommended Run Schedule

To ensure optimal performance of your 7900HT Fast System, perform the calibration and verification runs as indicated in the table below.

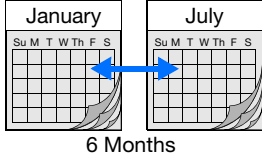
Schedule	Run Type
Semi-annually 	Perform a background calibration (see page 3) IMPORTANT! You must also perform a background calibration before performing a pure dye calibration and after installing a new, uncalibrated sample block.
	Perform a pure dye calibration (see page 17) IMPORTANT! You must also perform a pure dye calibration before performing an instrument verification run and after installing a new, uncalibrated sample block.
	Perform an instrument verification run (see page 32)

Notes _____

Performing a Background Calibration

Overview

When to Perform

Applied Biosystems recommends performing a background calibration:

- Every 6 months, or as often as needed depending on instrument use
- Before performing a pure dye calibration (see [page 17](#))
- After installing a new, uncalibrated sample block (see [page 53](#))

You can also perform background calibrations to detect and troubleshoot sample block contamination.

About the Background Calibration

A background calibration measures the level of ambient fluorescence in the 7900HT instrument. During the run, the 7900HT instrument performs a continuous scan of a background plate (which contains PCR buffer or deionized water) for 2 minutes at 60 °C. Afterwards, the SDS software averages the spectrum recorded during the run and extracts the resulting spectral component to a calibration file. The SDS software uses the calibration file during subsequent runs to remove the background signal from the run data.

About the Background Component

Fluorescence collected by the 7900HT Fast System includes a fluorescent signal inherent to the system, commonly referred to as background fluorescence. This background component is a composite signal found in all spectral data that consists of fluorescence from several sources, including: the background electronic signal, the sample block, the water inside the consumable, and the consumable itself. Because the background fluorescence can interfere with the precision of the data collected by the 7900HT System, the instrument is engineered to minimize the background signal; additionally, the SDS software algorithmically eliminates the background signal from each fluorescent sample to maximize the instrument's sensitivity.

Notes _____

Before You Begin

Time Required 30 minutes

Materials Required You need the materials listed below to perform this procedure.

For 384- or 96-Well Sample Blocks

Powder-free gloves and safety goggles

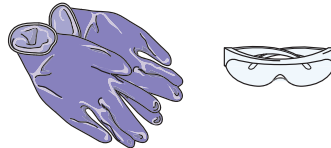

Background plate from one of the following calibration kits:

- Sequence Detection Systems 384-Well Spectral Calibration Kit (PN 4323977)
- ABI PRISM® 7900HT Sequence Detection Systems 96-Well Spectral Calibration Kit (PN 4328639)
- 7900HT System Fast 96-Well Spectral Calibration Kit (PN 4351653)

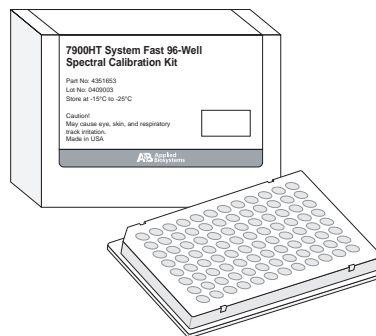

Centrifuge, with plate adapter

For the TaqMan Low Density Array Block

Powder-free gloves and safety goggles

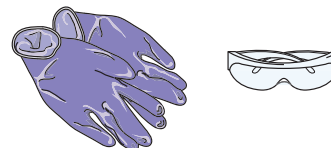

TaqMan® Low Density Array Spectral Calibration Kit (PN 4362745). Use:

- The tube of background solution
- One empty TLDA

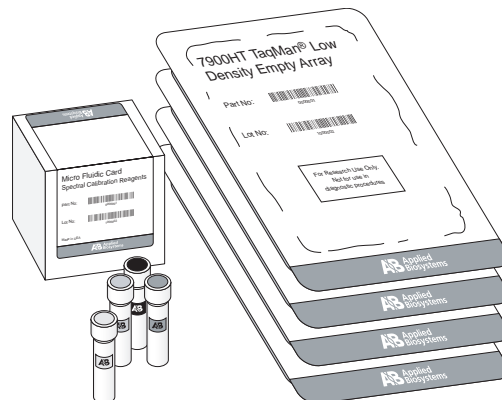

Notes _____

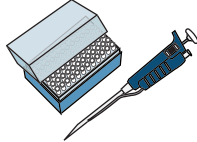
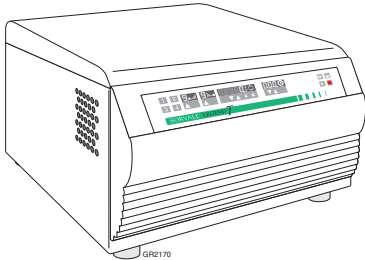
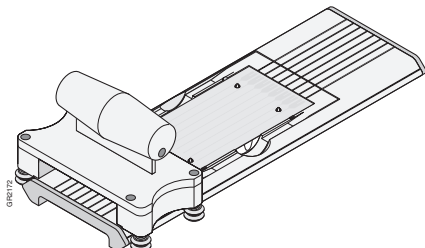
Vortex	
<p>Micropipettors and pipet tips:</p> <ul style="list-style-type: none">• Rainin F-100 micropipette (100-μL)• Rainin Fine Point pipet tips (100-μL)	
<p>Centrifuge (For more information, see the <i>TaqMan[®] Low Density Array Getting Started Guide</i>.)</p>	
<p>TaqMan[®] Low Density Array Sealer (For more information, see the <i>TaqMan[®] Low Density Array Getting Started Guide</i>.)</p>	

Workflow To perform the background calibration:

1. Obtain the tools and materials required (see [pages 4 and 5](#)).
2. Prepare the background plate (see [page 6](#)) or background TLDA (see [page 9](#)).
3. Create a plate document (see [page 10](#)).
4. Run the background plate or background TLDA (see [page 12](#)).
5. Analyze the background data (see [page 14](#)).

Troubleshooting If you experience problems with the background calibration, see “[Troubleshooting Background Calibrations](#)” on [page 15](#).

Notes _____

Preparing the Background Plate

IMPORTANT! Wear powder-free gloves when you handle the background plate.



1. Retrieve the calibration kit from the freezer and remove the packaged background plate from within it.
2. Return the calibration kit to the freezer.



3. Allow the background plate to warm to room temperature (approximately 5 min).

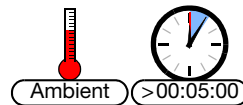

4. Remove the background plate from its packaging.

IMPORTANT! Do not discard the packaging for the background plate. The background plate can be used repeatedly if it is stored in its original packaging sleeve.



5. Briefly centrifuge the background plate in a centrifuge with plate adapter.

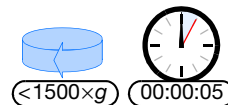

Notes _____

- 6. Verify that the liquid in each well of the background plate is positioned at the bottom of the well. If not, centrifuge the plate again at a higher rpm and for a longer period of time.

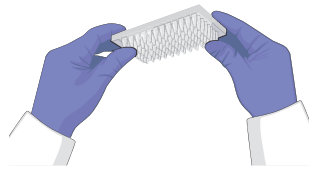

IMPORTANT! Do not allow the bottom of the background plate to become dirty. Fluids and other contaminants that adhere to the bottom of the plate can contaminate the sample block and cause an abnormally high background signal.

Correct	Incorrect
<p>Sample is positioned at bottom of well.</p>	<p>The plate has not been centrifuged with enough force, or has not been centrifuged for enough time.</p>

- 7. Proceed to “[Creating a Background Plate Document](#)” on page 10.

Notes _____

Creating a Background Plate

If a background plate from a calibration kit is not available, you can create one to perform the background calibration by following the procedure below. Whenever possible, Applied Biosystems recommends the use of the background plate included with the calibration kit because it contains a PCR buffer that more accurately models the reagents used for PCR, and therefore produces better calibration data.

Materials Required

Pipettor, 100 to 200- μ L (with pipet tips)

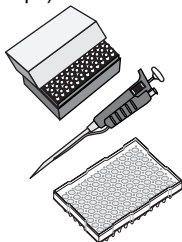

Reaction plate
(see note at right)

Deionized water

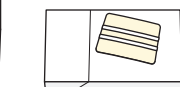

Optical adhesive cover
or Optical Caps
(PN 4323032)

Safety glasses

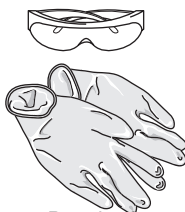

Powder-free
gloves

Note: Reaction plate options are:

- 384-Well Clear Optical Reaction Plate (standard 384-well reaction plate)
- MicroAmp® 96-Well Optical Reaction Plate (standard 96-well reaction plate)
- Optical 96-Well Fast Thermal Cycling Plate (Fast 96-well reaction plate)

To create the background plate:

IMPORTANT! Wear powder-free gloves while creating the background plate.



1. Remove a reaction plate from its box and place it on a clean, dry surface.
2. Aliquot deionized water to each well of the reaction plate, as follows:
 - 20 μ L per well for a standard 384-well or Fast 96-well reaction plate
 - 50 μ L per well for a standard 96-well reaction plate
3. Seal the plate:
 - For standard 384-well or Fast 96-well reaction plates, use only an optical adhesive cover.
 - For standard 96-well reaction plates, use an optical adhesive cover or optical flat caps.
4. Continue with [step 5 on page 6](#).



Pipet deionized water to each well

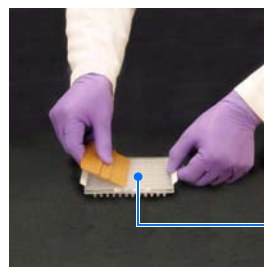

Seal the plate

Notes

Preparing the Background TLDA

1. Retrieve the calibration kit from the freezer and remove:
 - The tube of background solution
 - One empty TLDA
2. Return the calibration kit to the freezer.

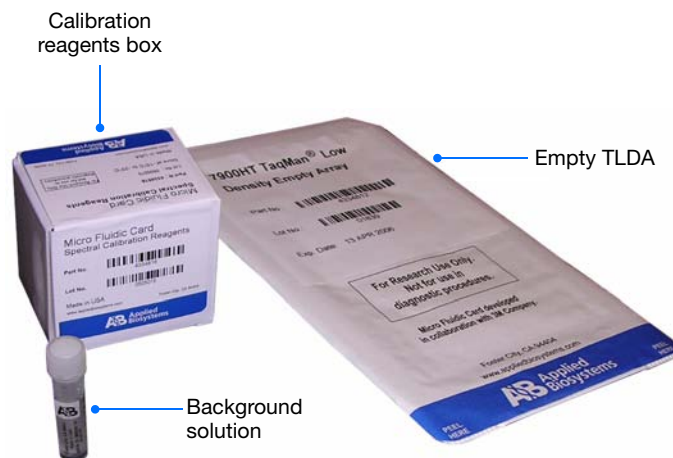

3. Allow the background solution to thaw at room temperature.
4. When the solution has thawed, vortex the tube.
5. Load the background solution into the empty TLDA, loading 100 μ L of solution per fill reservoir.

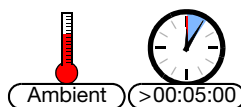

Note: For detailed loading procedures see the *TaqMan® Low Density Array Getting Started Guide*.

6. Centrifuge and seal the background TLDA.

Note: For centrifuging and sealing procedures see the *TaqMan® Low Density Array Getting Started Guide*.

7. Proceed to “[Creating a Background Plate Document](#)” on page 10.

Notes

Creating a Background Plate Document

1. Double-click  on the desktop (or select **Start > All Programs > Applied Biosystems > SDS 2.3 > SDS 2.3**) to start the SDS software.
2. If the login option is enabled, the Login dialog box appears. Enter your **User Name** and **Password**, then click **OK**.

Note: If the login option is not enabled, no Login dialog box appears. Skip to [step 3](#) below.

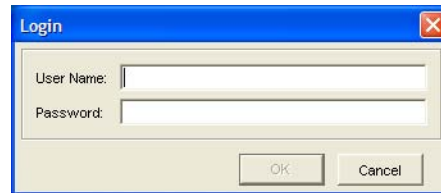

3. Click  (or select **File ▶ New**).
4. Complete the New Document dialog box:
 - a. Assay – Select **Background**.
 - b. Container – Select the appropriate format.
 - c. Template – Select the appropriate template, as described in the table below:

For Container...	Select Template...
384 Wells Clear Plate	Blank Template
96 Wells Clear Plate (for a Standard 96-Well Sample Block)	Blank Template
96 Wells Clear Plate (for a Fast 96-Well Sample Block)	Fast 96 Well Background Plate.sdt
384 Wells TaqMan Low Density Array	TaqMan Low Density Array Background Plate.sdt

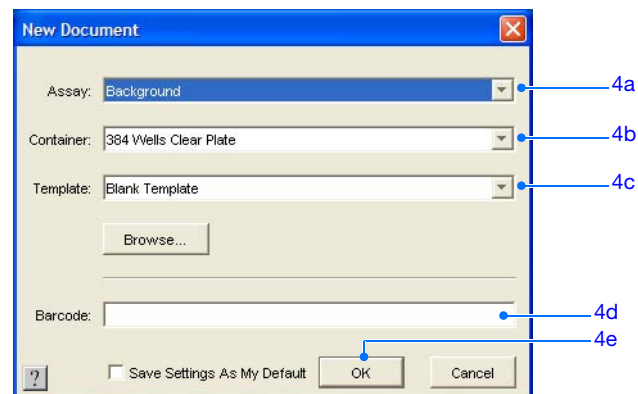

- d. If the background plate or background TLDA is labeled with a barcode, click the **Barcode** field, then type in or scan the barcode number.
- e. Click . The software creates and opens a plate document with the attributes for a background calibration.

IMPORTANT! Do not modify the background plate document. The method for a background calibration is coded into the SDS software and consists of a single

Notes

hold at 60 °C for 2 min. Because the plate contains only PCR buffer or deionized water, the plate document does not require sample or detector labels.

5. Save the plate document:
 - a. Click  (or select **File** ▶ **Save**) to open the Save As dialog box.
 - b. If the Save in field does not display SDS Documents, navigate to **Applied Biosystems** ▶ **SDS Documents**.
 - c. In the File name field, type in an appropriate file name, as described in the table below.

For Container...	Type...
384 Wells Clear Plate	Background_<date in MMDDYY format> For example, the file name for a plate run on May 31, 2005, would be: Background_053105 .
96 Wells Clear Plate (for a Standard 96-Well Sample Block)	Background_<date in MMDDYY format> For example, the file name for a plate run on May 31, 2005, would be: Background_053105 .
96 Wells Clear Plate (for a Fast 96-Well Sample Block)	FastBackground_Plate_<date in MMDDYY format> For example, the file name for a Fast plate run on May 31, 2005, would be: FastBackground_053105 .
384 Wells TaqMan Low Density Array	Background<date in MMDDYY format>_TLDA For example, the file name for a background TLDA run on May 31, 2005, would be: Background_053105_TLDA .

- d. Select **SDS 7900HT Document (*.sds)** from the Files of type drop-down list.
- e. Click . The software saves the plate document.

6. Continue with “[Running the Background Plate or Background TLDA](#)” on page 12.

5b. This should be SDS Documents

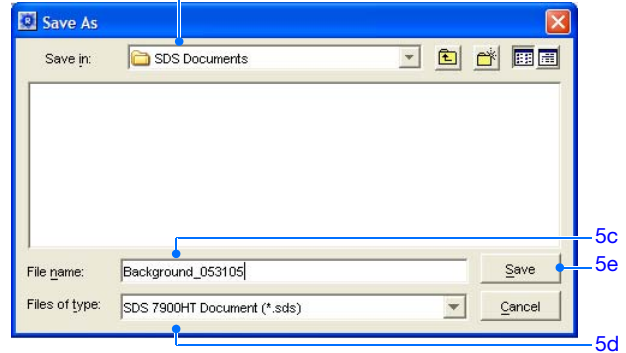

Notes

Running the Background Plate or Background TLDA

1. In the background plate document, select the **Instrument** ► **Real-Time** tabs.
2. Click . The instrument tray rotates to the OUT position.

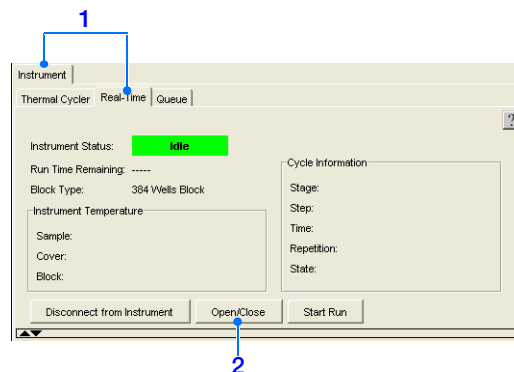

3. Place the background plate or background TLDA into the instrument tray as shown.

IMPORTANT! The background plate or TLDA must be oriented so that the A1 position matches the A1 label on the instrument tray.

Standard 384-well reaction plate

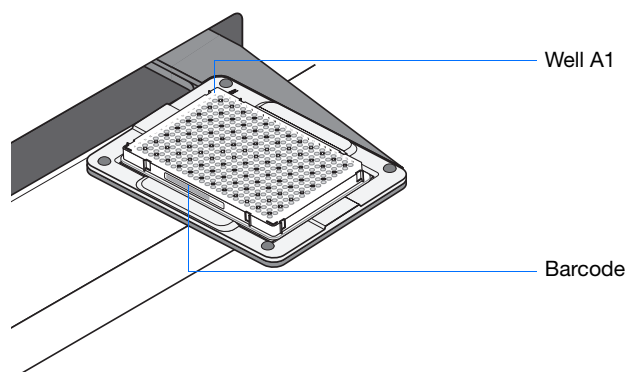

4. Click . The instrument tray rotates to the IN position and performs the background calibration.

Note: Before starting the run, the instrument may pause (up to 15 min) to bring the heated cover to the appropriate temperature.

5. When the background calibration is complete and the Run Complete dialog box appears, click to close the dialog box.

Notes _____

- Click , then remove the background plate or background TLDA from the instrument tray.



WARNING PHYSICAL INJURY

HAZARD. During instrument operation, the sample block can be heated as high as 100 °C. Before removing the background plate or background TLDA, be sure to wait until the sample block reaches room temperature.

- Place the background plate or background TLDA back inside its packaging, then return it to the calibration kit in the freezer.

IMPORTANT! Do not discard the background plate or background TLDA. If you store it in its original packaging, you can use the background plate or background TLDA for up to 6 months after you open it.



- Continue with “[Analyzing the Background Data](#)” on page 14.

Notes _____

Analyzing the Background Data

When you analyze the background data, the SDS software extracts the calibration values from the background plate document, then provides pass/fail information. After extraction, the SDS software stores the data as part of the calibration file located in the Calibration subdirectory of the SDS directory.

To analyze the background data:

1. In the Plate Grid of the background plate document, click the box above the A label to select all wells.

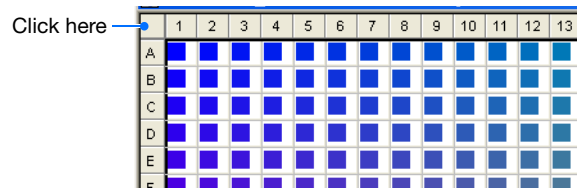

2. Select **Analysis** ▶ **Extract Background**.

The software attempts to extract the background signal and displays the success of the extraction in a dialog box.

3. If the software displays:

Calibration Update Complete – The analysis is successful. The raw spectra read from the background plate conform to acceptable limits.

Click , then go to [step 4](#).

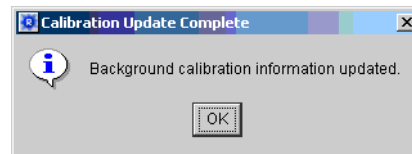

Error – The run is unsuccessful. The software stopped the extraction because one or more raw spectra exceed 4000 FSU.

Click , then troubleshoot the failed run as explained in [“Troubleshooting Background Calibrations”](#) on page 15.

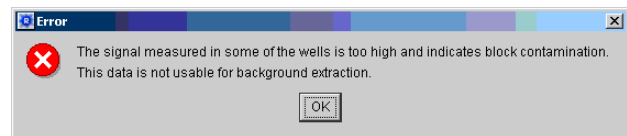

4. Click  (or select **File** ▶ **Save**) to save the background plate document.
5. Select **File** ▶ **Close** to close the background plate document.

Notes _____

Troubleshooting Background Calibrations

Troubleshooting Table

Table 1-1 Troubleshooting background calibrations

Observation	Possible Cause	Recommended Action
Software will not extract background data	During setup, the wrong plate type was assigned to the plate document	Run a new background plate document with the proper plate type setting.
	Background is too high (>4000 FSU [‡])	See “ Isolating Sample Block Contamination ” below.
Background is too high (>4000 FSU)	Sample block contamination	1. Construct and run a new background plate. 2. See “ Isolating Sample Block Contamination ” below.
	Background plate contamination	

[‡]Fluorescent standard units – The measure of amplitude displayed along the Y-axis of the Background Plot.

Isolating Sample Block Contamination

Signals exceeding 4000 FSU are considered outside the limit of normal background fluorescence and indicates that the either the background plate or the sample block may be contaminated.

1. Open the plate document for the background calibration.
2. In the toolbar, click  (**Hide/Show System Raw Data Pane**).
3. Select all wells in the plate document.

The SDS software highlights the selected wells and displays the raw spectral data.

4. Inspect the raw background data for an aberrant spectral peak or peaks.

Wells producing raw spectra that exceed 4000 FSU are considered irregular and could be contaminated. The following figure illustrates the raw data produced by a run on a sample block module containing a contaminated well.

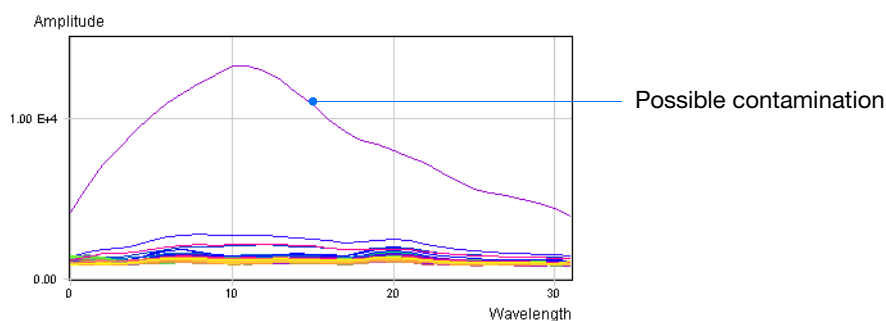

5. Drag the vertical bar in the temperature plot to inspect all the data points. The location(s) of the contaminated well(s) is displayed in tooltip when you move the mouse over the curves in the graph.

Notes



Chapter 1 Performing Calibration and Verification Runs

Performing a Background Calibration

6. Decontaminate the sample block as explained on [page 65](#).
7. Run a background plate to confirm that the contaminants have been removed.
If the contamination is present after running the background plate for a second time, the background plate is likely to be the source of contamination.

Notes _____

Performing a Pure Dye Calibration

Overview

When to Perform Applied Biosystems recommends performing a pure dye calibration:

- Every 6 months, depending on instrument use

IMPORTANT! The age and use of instrument components can affect pure spectra readings. Update the pure spectra data files once or twice annually, depending on the frequency of instrument use.

- Before performing an instrument verification run (see [page 32](#))
- After installing a new, uncalibrated sample block (see [page 53](#))

Purpose of the Pure Dye Calibrations

Before operating the instrument, you must generate spectral data by performing a pure dye calibration. During the pure dye calibration, the SDS software collects spectral data from a set of pure dye standards during a 2-minute hold at 60 °C. The SDS software stores the spectral data in the pure spectra run file, a calibration file located in the SDS directory. The SDS software uses the spectral data from the set of pure dye standards to distinguish the individual contribution of each dye in the collective fluorescence gathered by the instrument during a run.

After each run, the SDS software receives run data in the form of a raw spectra signal for each reading. To make sense of the raw data, the software must determine the contribution of each fluorescent dye used in the sample by comparing the raw spectra to the spectral data contained in the pure spectra run file.

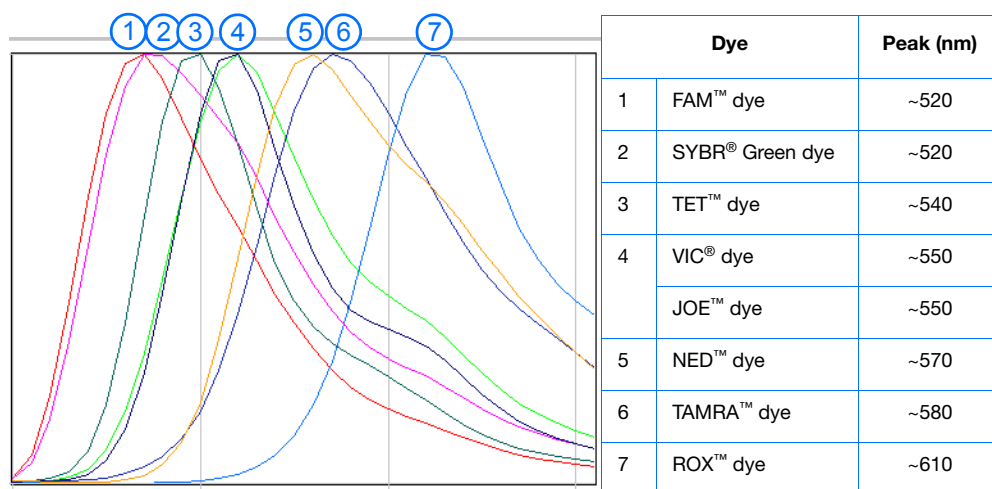

Note: When a plate document is saved after analysis, the SDS software stores the pure spectra information with the collected fluorescent data for that experiment.

Notes _____

**Components of
the Pure Dye
Standards**

The 7900HT Fast System is calibrated with several dyes, which are included in the calibration kits.

- The Sequence Detection Systems 384-Well Spectral Calibration Kit is provided for the standard 384-well sample block. This kit includes one 384-well pure dye plate, preloaded with the following dyes: FAM™ dye, JOE™ dye, NED™ dye, ROX™ dye, SYBR® Green dye, TAMRA™ dye, TET™ dye, and VIC® dye.
- The ABI PRISM® 7900HT Sequence Detection Systems 96-Well Spectral Calibration Kit is provided for the standard 96-well sample block. This kit includes two 96-well pure dye plates. Plate 1 is preloaded with the following dyes: FAM™ dye, JOE™ dye, NED™ dye, and ROX™ dye. Plate 2 is preloaded with the following dyes: SYBR® Green dye, TAMRA™ dye, TET™ dye, and VIC® dye.
- The 7900HT System Fast 96-Well Spectral Calibration Kit is provided for the Fast 96-well sample block. This kit includes two 96-well pure dye plates. Plate 1 is preloaded with the following dyes: FAM™ dye, JOE™ dye, NED™ dye, and ROX™ dye. Plate 2 is preloaded with the following dyes: SYBR® Green dye, TAMRA™ dye, TET™ dye, and VIC® dye.
- The TaqMan® Low Density Array Spectral Calibration Kit is provided for the TaqMan® Low Density Array block. The kit includes three tubes of dye: FAM™ dye, ROX™ dye, and VIC® dye and three empty TLDA. To perform a pure dye calibration, you load each dye into an empty TLDA.

**Custom Pure
Dyes**

The 7900HT Fast System supports the detection of custom pure dyes (dyes other than those provided by Applied Biosystems). To add custom pure dyes to the pure dye set for your instrument, see [Appendix A on page 141](#).

Notes _____

Before You Begin

Time Required 30 minutes

Materials Required You need the materials listed below to perform this procedure.

For 384- or 96-Well Sample Blocks

Powder-free gloves and safety goggles

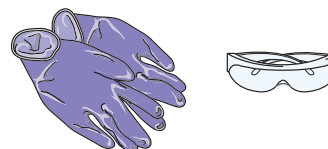

Pure dye plate(s) from one of the following calibration kits:

- Sequence Detection Systems 384-Well Spectral Calibration Kit (PN 4323977)
- ABI PRISM® 7900HT Sequence Detection Systems 96-Well Spectral Calibration Kit (PN 4328639)
- 7900HT System Fast 96-Well Spectral Calibration Kit (PN 4351653)



Note: Both the standard 96-well and Fast 96-well calibration kits contain two pure dye plates.

Centrifuge, with plate adapter

For the TaqMan Low Density Array Block

Powder-free gloves and safety goggles

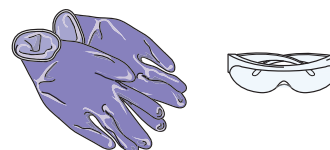

TaqMan® Low Density Array Spectral Calibration Kit (PN 4362745). Use:

- The three dye tubes: FAM™ dye, ROX™ dye, and VIC® dye
- Three empty TLDAs

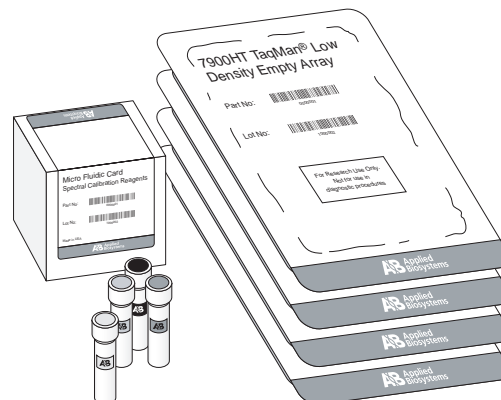

Notes _____

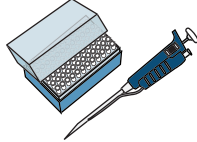
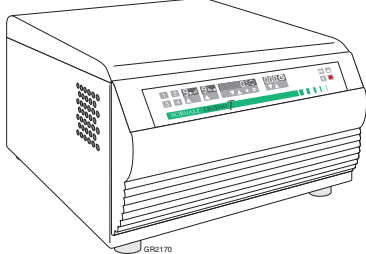
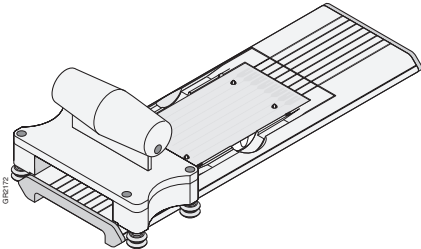
<p>Vortex</p> <p>Micropipettors and pipet tips:</p> <ul style="list-style-type: none"> • Rainin F-100 micropipette (100-μL) • Rainin Fine Point pipet tips (100-μL) 	
<p>Centrifuge (For more information, see the <i>TaqMan[®] Low Density Array Getting Started Guide</i>.)</p>	
<p>TaqMan[®] Low Density Array Sealer (For more information, see the <i>TaqMan[®] Low Density Array Getting Started Guide</i>.)</p>	

Workflow To perform the pure dye calibration:

1. Perform a background calibration first (see [page 3](#))

IMPORTANT! You must perform a background calibration before every pure dye calibration.

2. Obtain the tools and materials required (see [pages 19 and 20](#)).
3. Prepare the pure dye plate(s) (see [page 21](#)) or pure dye TLDA(s) (see [page 23](#)).
4. Create a plate document (see [page 24](#)).
5. Run the pure dye plate(s) or pure dye TLDA(s) (see [page 27](#)).
6. Analyze the pure dye data (see [page 29](#)).

Troubleshooting If you experience problems with the pure dye calibration, see “[Troubleshooting Pure Dye Calibrations](#)” on [page 31](#).

Notes _____

Preparing the Pure Dye Plate(s)

IMPORTANT! You must perform a background calibration before every pure dye calibration.

IMPORTANT! Wear powder-free gloves when you handle the pure dye plates.



1. Retrieve the calibration kit from the freezer, then remove the packaged pure dye plate(s).

Note: The standard 384-well calibration kit contains one pure dye plate. Both the standard 96-well and Fast 96-well calibration kits contain two pure dye plates.



2. Return the calibration kit to the freezer.
3. Allow the pure dye plate(s) to warm to room temperature (approximately 5 min).

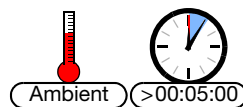

4. Remove a pure dye plate from its packaging.

IMPORTANT! Do not remove a pure dye plate from its packaging until you are ready to run it. The fluorescent dye contained in the wells of each pure dye plate is photosensitive. Prolonged exposure to light can diminish the fluorescent signal strength of the plate.



IMPORTANT! Do not discard the packaging for the pure dye plate. The pure dye plate can be used repeatedly if it is stored in its original packaging sleeve.

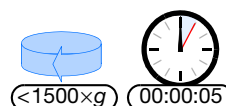

5. Briefly centrifuge the pure dye plate in a centrifuge with plate adapter.

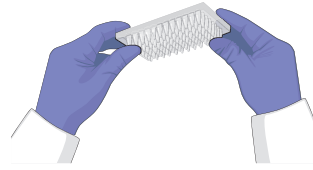

Notes

6. Verify that the pure dye standard in each well of the pure dye plate is positioned at the bottom of the well. If not, centrifuge the plate again at a higher rpm and for a longer period of time.



Correct	Incorrect	
 <p data-bbox="821 758 976 842">Sample is positioned at bottom of well.</p>		 <p data-bbox="1065 758 1438 842">The plate has not been centrifuged with enough force, or has not been centrifuged for enough time.</p>

7. Proceed to [“Creating a Pure Dye Plate Document”](#) on page 24.

Notes _____

Preparing the Pure Dye TLDA

IMPORTANT! You must perform a background calibration before every pure dye calibration.

IMPORTANT! Wear powder-free gloves when performing this procedure.



WARNING Spectral Calibration Bulk FAM™, ROX™, and VIC® Dyes are combustible liquids and vapors. Exposure causes eye, skin, and respiratory tract irritation. Read the MSDS, and follow the handling instructions. Wear appropriate protective eyewear, clothing, and gloves.

1. Retrieve the calibration kit from the freezer and remove:
 - The three dye tubes: FAM dye, ROX dye, and VIC dye
 - Three empty TLDA
2. Return the calibration kit to the freezer.

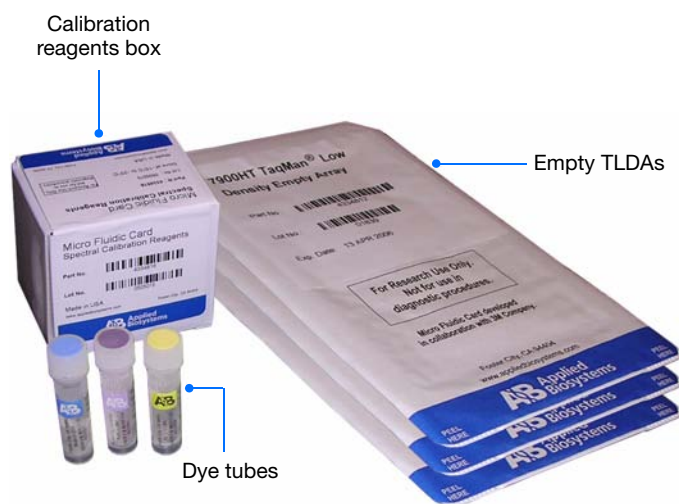

3. Allow the dyes to thaw at room temperature.

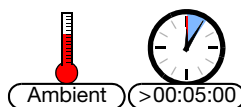

4. When the dyes have thawed, vortex the tubes.
5. Load the FAM dye into one of the empty TLDA, loading 100 µL of dye per fill reservoir.

Note: For detailed loading procedures see the *TaqMan® Low Density Array Getting Started Guide*.

Notes

6. Repeat [step 5](#) for the ROX and VIC dyes, using the two remaining empty TLDAs.
7. Centrifuge and seal the pure dye TLDAs.

Note: For centrifuging and sealing procedures see the *TaqMan® Low Density Array Getting Started Guide*.

8. Proceed to “[Creating a Pure Dye Plate Document](#)” on page 24.

Creating a Pure Dye Plate Document

1. Double-click  on the desktop (or select **Start > All Programs > Applied Biosystems > SDS 2.3 > SDS 2.3**) to start the SDS software.
2. If the login option is enabled, the Login dialog box appears. Enter your **User Name** and **Password**, then click **OK**.

Note: If the login option is not enabled, no Login dialog box appears. Skip to [step 3](#) below.

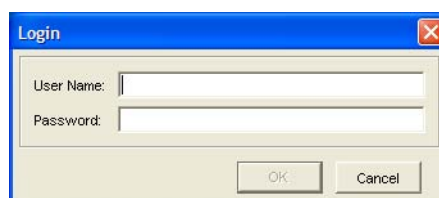

3. Click  (or select **File ▶ New**).
4. Complete the New Document dialog box:
 - a. Assay – Select **Pure Spectra**.
 - b. Container – Select the appropriate format.
 - c. Template – Select the appropriate template, as described in the table below.

For Container...	Select Template...
384 Wells Clear Plate	384 Well Pure Dyes Plate.sdt
96 Wells Clear Plate (for a Standard 96-Well Sample Block)	<ul style="list-style-type: none"> • 96 Well Pure Dyes Plate 1.sdt to run Plate 1 (containing FAM, JOE, NED, and ROX dyes) • 96 Well Pure Dyes Plate 2.sdt to run Plate 2 (containing SYBR Green, TAMRA, TET, and VIC dyes)

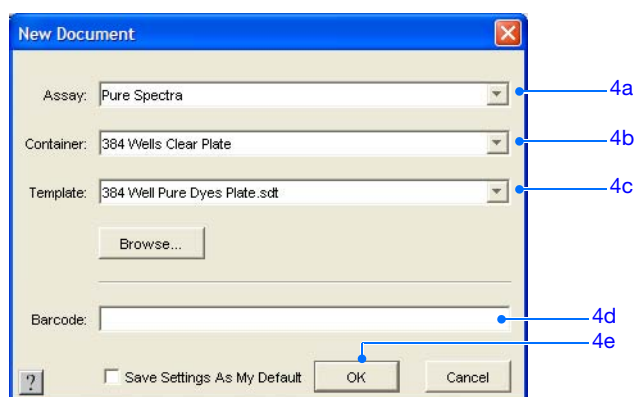

Notes

For Container...	Select Template...
96 Wells Clear Plate (for a Fast 96-Well Sample Block)	<ul style="list-style-type: none"> • Fast 96 Well Pure Dyes Plate 1.sdt to run Plate 1 (containing FAM, JOE, NED, and ROX dyes) • Fast 96 Well Pure Dyes Plate 2.sdt to run Plate 2 (containing SYBR Green, TAMRA, TET, and VIC dyes)
384 Wells TaqMan Low Density Array	<ul style="list-style-type: none"> • TaqMan Low Density Array FAM Pure Dye.sdt to run the pure dye TLDA containing FAM dye • TaqMan Low Density Array ROX Pure Dye.sdt to run the pure dye TLDA containing ROX dye • TaqMan Low Density Array VIC Pure Dye.sdt to run the pure dye TLDA containing VIC dye

- d. If the pure dye plate or pure dye TLDA is labeled with a barcode, click the **Barcode** field, then type in or scan the barcode number.
- e. Click . The software creates and opens a plate document with the attributes for a pure dye calibration.

IMPORTANT! Do not modify the pure dye plate document.

5. Save the plate document:

- a. Click (or select **File** ▶ **Save**) to open the Save As dialog box.
- b. If the Save in field does not display SDS Documents, navigate to **Applied Biosystems** ▶ **SDS Documents**.
- c. In the File name field, type in an appropriate file name, as described in the table below.

For Container...	Type...
384 Wells Clear Plate	<p>PureDye_<date in MMDDYY format></p> <p>For example, the file name for a plate run on May 31, 2005, would be: PureDye_053105.</p>
96 Wells Clear Plate (for a Standard 96-Well Sample Block)	<p>PureDye_Plate<plate #>_<date in MMDDYY format></p> <p>For example, the file name for a Plate 1 run on May 31, 2005, would be: PureDye_Plate1_053105.</p>

5b. This should be SDS Documents

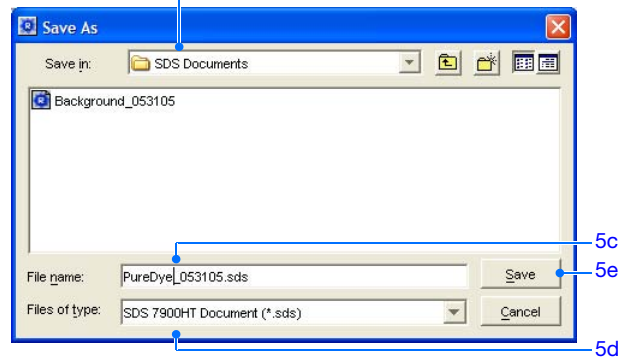

Notes

For Container...	Type...
96 Wells Clear Plate (for a Fast 96-Well Sample Block)	<p>FastPureDye_Plate<plate #>_<date in MMDDYY format></p> <p>For example, the file name for a Fast Plate 1 run on May 31, 2005, would be: FastPureDye_Plate1_053105.</p>
384 Wells TaqMan Low Density Array	<p><Dye><date in MMDDYY format>_TLDA</p> <p>For example, the file name for a FAM dye TLDA run on May 31, 2005, would be: FAM_053105_TLDA.</p>

- d. Select **SDS 7900HT Document (*.sds)** from the Files of type drop-down list.
 - e. Click . The software saves the plate document.
6. Continue with [“Running a Pure Dye Plate or Pure Dye TLDA”](#) on page 27.

Notes _____

Running a Pure Dye Plate or Pure Dye TLDA

1. In the pure dye plate document, select the **Instrument ▶ Real-Time** tabs.
2. Click . The instrument tray rotates to the OUT position.

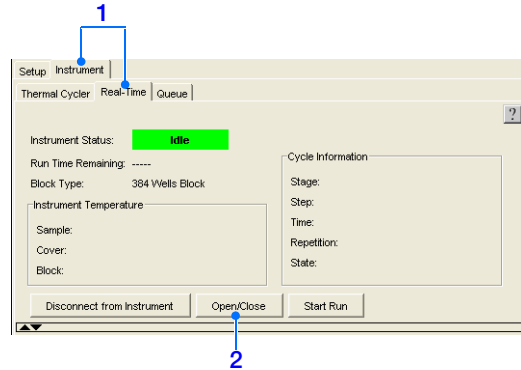

3. Place the pure dye plate or pure dye TLDA into the instrument tray as shown.

IMPORTANT! The pure dye plate or TLDA must be oriented so that the A1 position matches the A1 label on the instrument tray.

Standard 384-well reaction plate

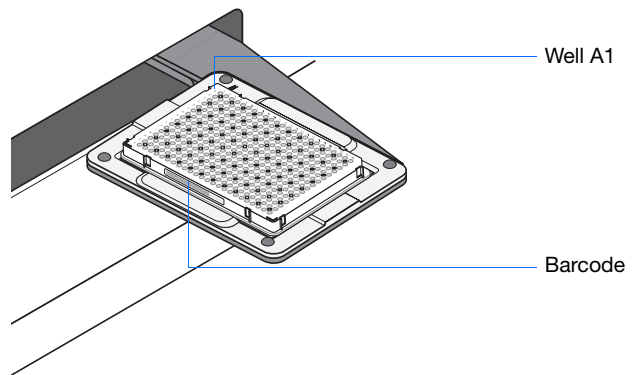

4. Click . The instrument tray rotates to the IN position and performs the pure dye calibration.

Note: Before starting the run, the instrument may pause (up to 15 min) to bring the heated cover to the appropriate temperature.

5. When the pure dye calibration is complete and the Run Complete dialog box appears, click to close the dialog box.

Notes

6. Click , then remove the pure dye plate or pure dye TLDA from the instrument tray.

**WARNING PHYSICAL INJURY**

HAZARD. During instrument operation, the sample block can be heated as high as 100 °C. Before removing the background plate or background TLDA, be sure to wait until the sample block reaches room temperature.

7. Place the pure dye plate or each pure dye TLDA inside its packaging, then return it to the calibration kit in the freezer.

IMPORTANT! Do not discard the pure dye plate or pure dye TLDA. If you store it in its original packaging, you can use the pure dye plate or each pure dye TLDA for up to 6 months after you open it.

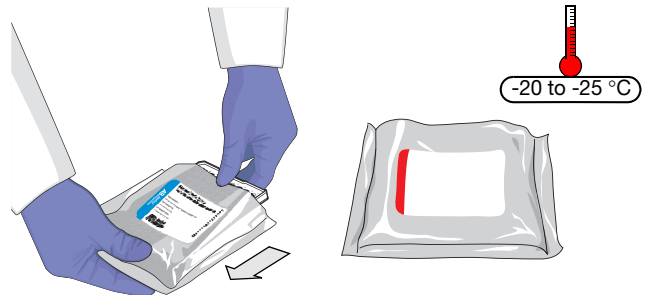

8. Continue with “[Analyzing the Pure Dye Data](#)” on page 29.

Notes _____

Analyzing the Pure Dye Data

When you analyze the pure dye data, the SDS software extracts the calibration values from the pure dye plate document, then displays the spectral data in the Pure Dye Wizard.

The purpose of viewing the data in the Pure Dye Wizard is to eliminate irregular pure dye peaks from the data set. The wizard presents the spectral data in sets of three wells, each containing the same pure dye. Because the wells displayed by the wizard contain the pure dye at an identical concentration, the signal peaks for the set should be identical. Occasionally, pipetting inaccuracies or contamination can cause a well signal to shift slightly. While viewing the data, you must eliminate any outlying peaks.

To analyze the pure dye data:

1. In the pure dye plate document, select **Analysis ▶ Extract Pure Dye Wizard**.
2. Follow the instructions as explained in the Pure Dye Wizard to extract the pure dye spectra.
 When presented with each screen:

- a. Inspect the spectra for shifts in peak location.
- b. If the data set contains an outlying peak, eliminate it by clicking the check box of the associated well.

Note: Dye spectra are generally acceptable if they peak at the same location as their group but diverge slightly at other wavelengths.

- c. Click when finished.
- d. Repeat **steps a through c** for all remaining wells until prompted with a message reporting the extraction of the pure dyes.

The software extracts the pure spectra and stores the data as a component of the calibration file.

3. Click  (or select **File ▶ Save**) to save the pure dye plate document.

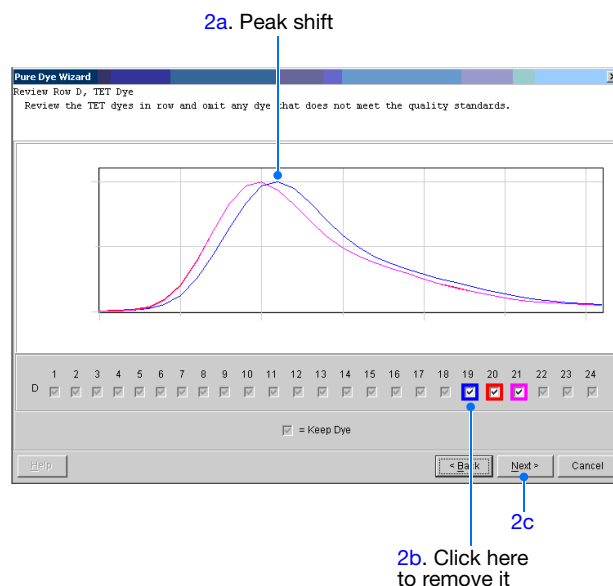

Notes

4. Select **File** ► **Close** to close the pure dye plate document.
5. If you are performing the pure dye calibration for a:
 - Standard 384-well sample block – The pure dye calibration is complete.
 - Standard 96-well or Fast 96-well sample block – Run the second pure dye plate by repeating the following procedures:
 - “Creating a Pure Dye Plate Document” on page 24
 - “Running a Pure Dye Plate or Pure Dye TLDA” on page 27
 - “Analyzing the Pure Dye Data” on page 29
 - TaqMan Low Density Array – Run the second and third pure dye TLDAs by repeating the following procedures for each TLDA:
 - “Creating a Pure Dye Plate Document” on page 24
 - “Running a Pure Dye Plate or Pure Dye TLDA” on page 27
 - “Analyzing the Pure Dye Data” on page 29

IMPORTANT! You must calibrate the instrument for all pure dye plates or pure dye TLDAs provided in your calibration kit.

Notes _____

Troubleshooting Pure Dye Calibrations

Troubleshooting Table

Table 1-2 Troubleshooting pure dye calibrations

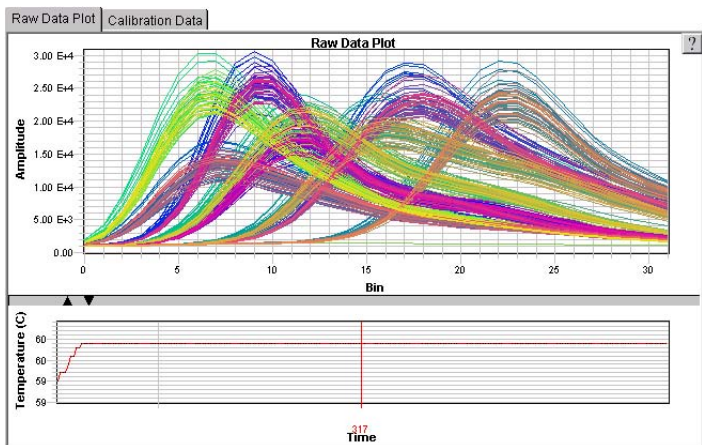
Observation	Possible Cause	Recommended Action
Software will not extract pure dye data	During plate setup, the wrong plate type was assigned to the plate document	Create and run a new pure dye plate document with the proper plate type setting
	A background plate was not run before the pure dye plate or TLDA	Run a background plate, then run the pure dye plate or TLDA again
Raw data from pure dye calibration appears strange (see below)	Pure dye plate or TLDA was loaded backwards	<ol style="list-style-type: none"> 1. Verify the pure dye wavelengths are as expected. 2. Rerun the pure dye plate or TLDA.
		
Signals plateau (saturation)	Intensity is set too high/low	Call Applied Biosystems Technical Support.
Signal is too low (<10,000 FSU)		
More than two outliers per dye in a single row	<ul style="list-style-type: none"> • Evaporation • Contamination 	Rerun the pure dye plate or TLDA. If the problem persists, discard the pure dye plate or TLDA and run a new one.

Notes _____

Performing an Instrument Verification Run

Overview

When to Perform Applied Biosystems recommends performing an instrument verification run:

- Every 6 months
- As needed to verify the function of the 7900HT Fast System

Purpose of the Verification Run

An instrument verification run is used to verify the performance of the 7900HT Fast System. During the run, TaqMan® RNase P reagents detect and quantify genomic copies of the human RNase P gene. (The RNase P gene is a single-copy gene encoding the RNA moiety of the RNase P enzyme.)

For the 7900HT Fast System instrument verification runs, the TaqMan RNase P reagents are available in the following formats:

- **TaqMan® RNase P Instrument Verification Plates (RNase P plates)** – Verifies instrument performance for 7900HT instruments that use a Standard 384-Well Block, Standard 96-Well Block, or Fast 96-Well Block.
- **TaqMan® Low Density Array RNase P Kit (TLDA RNase P kit)** – Verifies instrument performance for 7900HT instruments that use a TaqMan® Low Density Array Block.

About RNase P Plates

RNase P plates are pre-loaded with the reagents required to detect and quantify genomic copies of the human RNase P gene. Each well contains pre-loaded reaction mix (TaqMan® Universal PCR Master Mix, RNase P primers, and FAM™ dye-labeled probe) and a known concentration of human genomic DNA template.

Notes _____

The table below illustrates the arrangement of standards and samples on each type of RNase P plate that is available for the 7900HT Fast System. The RNase P plates contain five replicate groups of standards (1250, 2500, 5000, 10,000, and 20,000 copies), two unknown populations (5000 and 10,000 copies), and template control (NTC) wells.

RNase P Plate	Sample Configuration
TaqMan® RNase P 384-Well Instrument Verification Plate	
TaqMan® RNase P Instrument Verification Plate	
TaqMan® RNase P Fast 96-Well Instrument Verification Plate	

Notes _____

**About
the TLDA
RNase P Kit**

The TLDA RNase P Kit includes one empty TLDA and eight tubes of solution. Each tube of solution contains reaction mix (TaqMan® Universal PCR Master Mix, RNase P primers, and FAM™-MGB dye-labeled probe) and a known concentration of human genomic DNA template.

To perform an instrument verification run, you load each solution into the empty TLDA. The figure below illustrates the arrangement of standards and samples. There are five replicate groups of standards (200, 400, 800, 1600, and 3200 copies), two unknown populations (800 and 1600 copies), and no template control (NTC).

	1	2	3	4	5	6	7	8	9	10	11	12	13	14	15	16	17	18	19	20	21	22	23	24	PORT	
A										NTC														1		
B										Unknown A (800)														2		
C										Unknown B (1600)														3		
D										Standard 200														4		
E										Standard 400														5		
F										Standard 800														6		
G										Standard 1600														7		
H										Standard 3200														8		
I																										
J																										
K																										
L																										
M																										
N																										
O																										
P																										

Notes _____

Before You Begin

Time Required 2 hours

Materials Required You need the materials listed below to perform this procedure.

For 384- or 96-Well Sample Blocks

Powder-free gloves and safety goggles

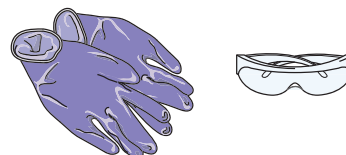

Appropriate RNase P plate for your sample block:

- TaqMan® RNase P 384-Well Instrument Verification Plate (PN 4323306)
- TaqMan® RNase P Instrument Verification Plate (PN 4310982, standard 96-well reaction plate)
- TaqMan® RNase P Fast 96-Well Instrument Verification Plate (PN 4351979)

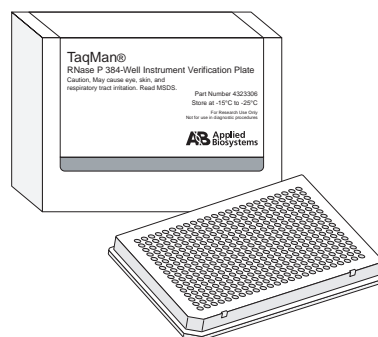

Centrifuge, with plate adapter

For the TaqMan Low Density Array Block

Powder-free gloves and safety goggles

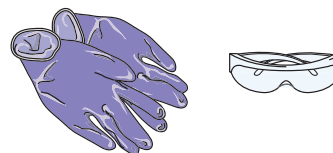

TaqMan® Low Density Array RNase P Kit (PN 4351468)

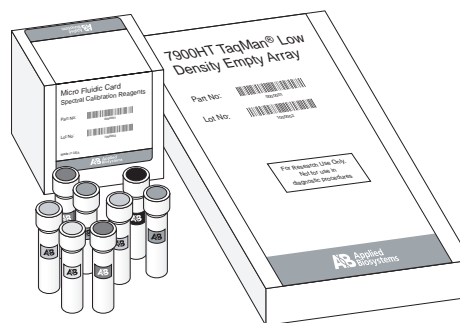

Notes _____

Micropipettors and pipet tips:

- Rainin F-100 micropipette (100- μ L)
- Rainin Fine Point pipet tips (100- μ L)

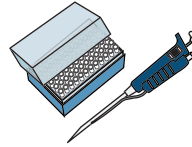
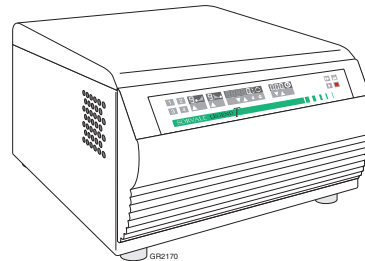
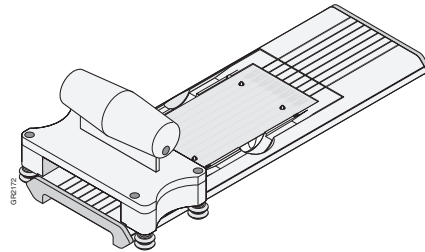
**Centrifuge** (For more information, see the *TaqMan[®] Low Density Array Getting Started Guide*.)**TaqMan[®] Low Density Array Sealer** (For more information, see the *TaqMan[®] Low Density Array Getting Started Guide*.)**Workflow** To perform an instrument verification run:

1. Perform a pure dye calibration (see [page 17](#)) before performing the instrument verification run.
2. Obtain the tools and materials required (see [pages 35 and 36](#)).
3. Prepare the RNase P plate (see [page 37](#)) or RNase P TLDA (see [page 39](#)).
4. Create a plate document (see [page 41](#)).
5. Run the RNase P plate or RNase P TLDA (see [page 43](#)).
6. Analyze the run data (see [page 44](#)).
7. Verify instrument performance (see [page 47](#)).

Notes

Preparing the RNase P Plate

IMPORTANT! Wear powder-free gloves when you handle the RNase P plate.



1. Retrieve the RNase P package from the freezer, then remove the packaged RNase P plate.

Note: For the standard 96-well RNase P plate, also use the compression pad provided in the package. Compression pads are not provided and should not be used for the Fast 96-well or standard 384-well RNase P plates.



2. Allow the RNase P plate to warm to room temperature (approximately 5 min).

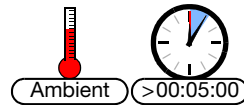

3. Remove the RNase P plate from its packaging.





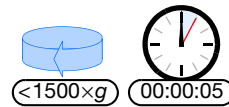

4. Briefly centrifuge the RNase P plate in a centrifuge with plate adapter.

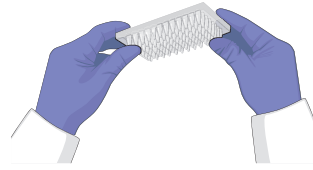

Notes _____

5. Verify that the liquid in each well of the RNase P plate is positioned at the bottom of the well. If not, centrifuge the plate again at a higher rpm and for a longer period of time.



Correct	Incorrect	
 <p data-bbox="821 751 976 842">Sample is positioned at bottom of well.</p>		 <p data-bbox="1062 751 1435 842">The plate has not been centrifuged with enough force, or has not been centrifuged for enough time.</p>

6. Proceed to “[Creating a Plate Document for the Verification Run](#)” on page 41.

IMPORTANT! To prevent degradation of the reaction components, start the run as soon as possible.

Notes _____

Preparing the RNase P TLDA

IMPORTANT! Wear powder-free gloves when performing this procedure.



1. Remove the TLDA RNase P kit from the freezer, then unpack the contents:
 - Eight tubes of solution
 - One empty TLDA
2. Remove the empty TLDA from its packaging.



3. Allow the eight tubes of solution to thaw at room temperature (approximately 5 min).
4. Mix the contents of each tube by tapping gently.
5. Using the empty TLDA, load 100 μ L of the first solution into the designated reservoir.

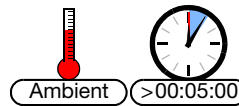

Note: The insert in the TLDA RNase P kit describes the designated reservoirs.

Note: For detailed loading procedures see the *TaqMan® Low Density Array Getting Started Guide*.

6. Repeat [step 5](#) for the remaining solutions.

Notes

7. Centrifuge and seal the three RNase P TLDAAs.

Note: For centrifuging and sealing procedures see the *TaqMan[®] Low Density Array Getting Started Guide*.

8. Proceed to “[Creating a Plate Document for the Verification Run](#)” on page 41.

IMPORTANT! To prevent degradation of the reaction components, start the run as soon as possible.

Notes _____

Creating a Plate Document for the Verification Run

1. Double-click  on the desktop (or select **Start > All Programs > Applied Biosystems > SDS 2.3 > SDS 2.3**) to start the SDS software.
2. If the login option is enabled, the Login dialog box appears. Enter your **User Name** and **Password**, then click **OK**.

Note: If the login option is not enabled, no Login dialog box appears. Skip to [step 3](#) below.

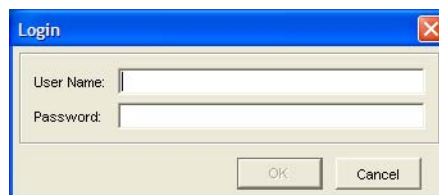

3. Click  (or select **File ▶ New**).
4. Complete the New Document dialog box:
 - a. Assay – Select **Standard Curve (AQ)**.
 - b. Container – Select the appropriate format.
 - c. Template – Select the appropriate template, as described in the table below.

For Container...	Select Template...
384 Wells Clear Plate	384 Well RNaseP Install Plate.sdt
96 Wells Clear Plate (for a Standard 96-Well Sample Block)	96 Well RNaseP Install Plate.sdt
96 Wells Clear Plate (for a Fast 96-Well Sample Block)	Fast 96 Well RNaseP Install.sdt
384 Wells TaqMan Low Density Array	TaqMan Low Density Array RNaseP.sdt

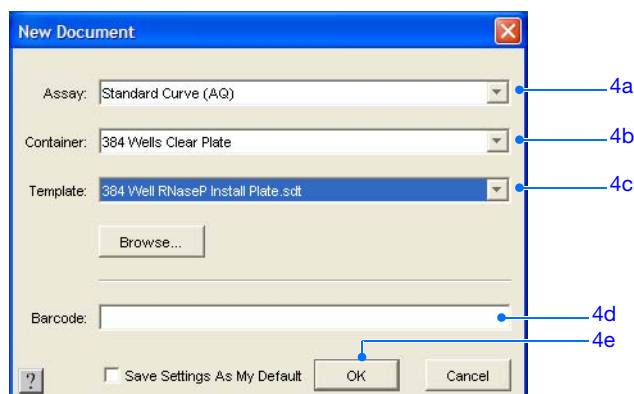

- d. If the RNase P plate or RNase P TLDA is labeled with a barcode, click the **Barcode** field, then type in or scan the barcode number.
- e. Click . The software creates and opens a plate document.

IMPORTANT! Do not modify the plate document. The plate document template is programmed with the appropriate detector and method information for the instrument verification run.

Notes

5. Save the plate document:

- a. Click  (or select **File ▶ Save**) to open the Save As dialog box.
- b. If the Save in field does not display SDS Documents, navigate to **Applied Biosystems ▶ SDS Documents**.
- c. In the File name field, type in an appropriate file name, as described in the table below.

For Container...	Type...
384 Wells Clear Plate	Verification_<date in MMDDYY format> For example, the file name for a plate run on May 31, 2005, would be: Verification_053105.
96 Wells Clear Plate (for a Standard 96-Well Sample Block)	Verification_<date in MMDDYY format> For example, the file name for a plate run on May 31, 2005, would be: Verification_053105.
96 Wells Clear Plate (for a Fast 96-Well Sample Block)	FastVerification_<date in MMDDYY format> For example, the file name for a Fast plate run on May 31, 2005, would be: FastVerification_053105.
384 Wells TaqMan Low Density Array	Verification<date in MMDDYY format>_TLDA For example, the file name for an RNase P TLDA run on May 31, 2005, would be: Verification_053105_TLDA.

- d. Select **SDS 7900HT Document (*.sds)** from the Files of type drop-down list.
- e. Click . The software saves the plate document.

6. Continue with “[Running the RNase P Plate or RNase P TLDA](#)” on page 43.

5b. This should be SDS Documents

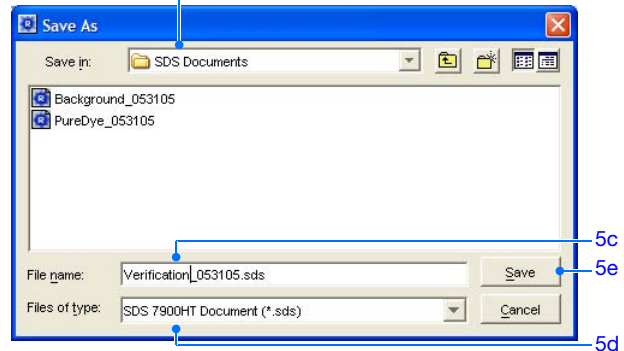

Notes _____

Running the RNase P Plate or RNase P TLDA

1. In the plate document, select the **Instrument ▶ Real-Time** tabs.
2. Click . The instrument tray rotates to the OUT position.

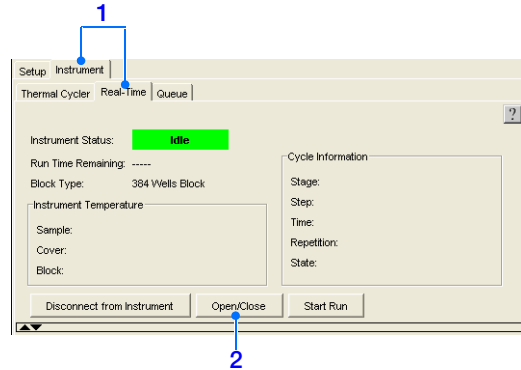

3. Place the RNase P plate or RNase P TLDA into the instrument tray as shown.

IMPORTANT! The RNase P plate or TLDA must be oriented so that the A1 position matches the A1 label on the instrument tray.

Standard 384-well reaction plate

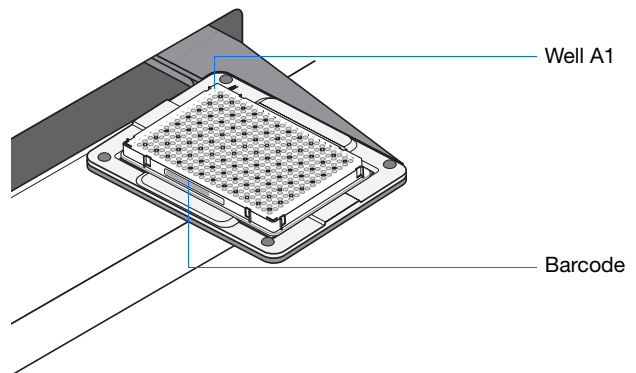

4. Click . The instrument tray rotates to the IN position and performs the instrument verification run.

Note: Before starting the run, the instrument may pause (up to 15 min) to bring the heated cover to the appropriate temperature.

5. When the instrument verification run is complete and the Run Complete dialog box appears, click to close the dialog box.

Notes

6. Click , then remove the RNase P plate or RNase P TLDA from the instrument tray.



WARNING PHYSICAL INJURY

HAZARD. During instrument operation, the sample block can be heated as high as 100 °C. Before removing the RNase P plate or RNase P TLDA, be sure to wait until the sample block reaches room temperature.

7. Proceed to “[Analyzing the Instrument Verification Run](#)” below.

Analyzing the Instrument Verification Run

1. Click  (or select **Analysis > Analyze**). The SDS software analyzes the run data. A status bar at the bottom of the plate document window indicates progress; the status bar disappears when the analysis is complete.
2. View the results:
 - a. In the Plate Grid, click the box above the A label to select all wells.
 - b. Click the **Results** tab to view the plots.
3. Choose from the following:
 - **Automatic Ct** – The SDS software automatically generates baseline values for each well and threshold values for each detector.

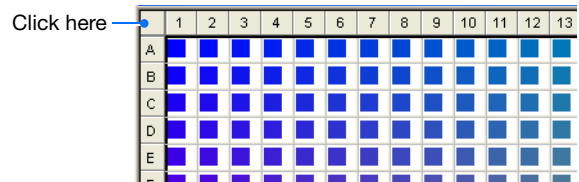

Notes _____

- **Manual Ct** – The SDS software calculates baseline and threshold values for a detector based on the assumption that the data exhibits typical amplification curves. If you are setting the baseline manually, specify the Start and End cycles.

IMPORTANT! After analysis, you must verify that the baseline and threshold were called correctly for each well by clicking on the well in the Plate Grid and viewing the resulting plots. For more information about manually adjusting the baseline and threshold settings, refer to the *Sequence Detection Systems Software version 2.3 Online Help (SDS Online Help)*.

4. If necessary, remove outliers:
 - a. Determine the outlier well positions.

Note: The C_T vs. Well Position view in the Results tab can help you determine the outlier well positions. To access this view, click the **Plot** drop-down list at the bottom of the Amplification Plot.

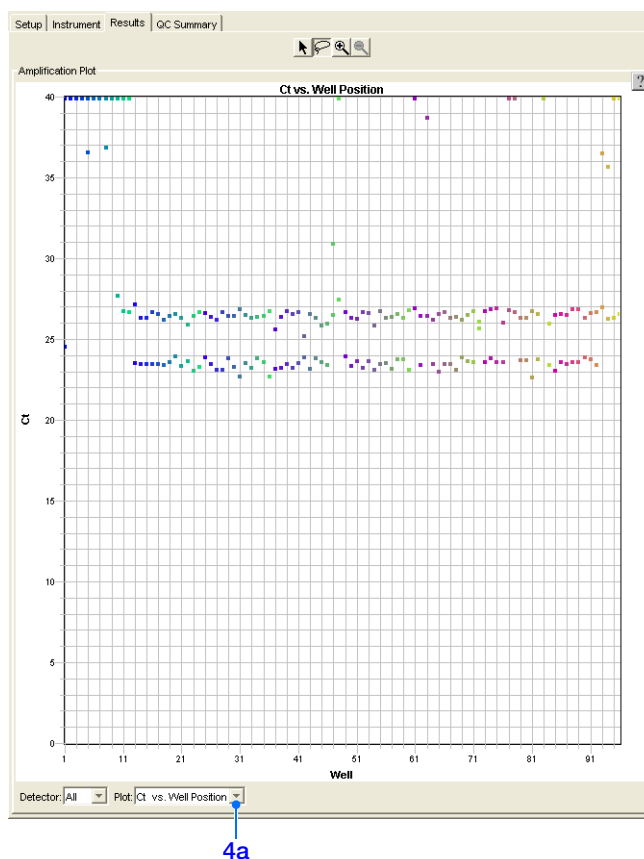

Notes _____

- b. In the Plate Grid, select the outlier wells.

Note: To select more than one well at a time, hold down the **ctrl** key while selecting the wells.

The number of wells that can be removed to pass specifications is shown in the table below.

Format	Maximum No. of Wells that Can be Removed from Each Set	
	Unknowns	Standards
Standard 96-well RNase P Plate	6	1
Fast 96-well RNase P Plate	6	1
Standard 384-well RNase P Plate	10	2
RNase P TLDA	4	4

- c. Click the **Setup** tab, then select the **Omit Wells(s)** check box. A red **×** appears in each of the selected wells in the Plate Grid.
5. Click  (or select **Analysis > Analyze**) to reanalyze the data.
6. Proceed to “[Verifying Instrument Performance](#)” on page 47.

Notes _____

Verifying Instrument Performance

Specification Calculation

During analysis, the SDS software generates a standard curve from the averaged threshold cycle (C_T) values of the replicate groups of standards, then calculates the concentration of the two unknown populations using the standard curve. To complete the verification, the average copy number (mean quantity) and standard deviation for the unknown populations are entered into the following formula to assess the instrument performance:

$$(\text{Qty Unk}_{(\text{high copy})}) - 3 (\text{Qty } \sigma_{(\text{high copy})}) > (\text{Qty Unk}_{(\text{low copy})}) + 3 (\text{Qty } \sigma_{(\text{low copy})})$$

where:

Calculation Term	Value	Unknown Populations			
		Standard 96-well RNase P Plate	Fast 96-well RNase P Plate	Standard 384-well RNase P Plate	RNase P TLDA
Qty Unk _(high copy)	Average quantity of high copy number	10,000	10,000	10,000	1600
Qty σ _(high copy)	Quantity standard deviation of high copy number				
Qty Unk _(low copy)	Average quantity of low copy number	5000	5000	5000	800
Qty σ _(high copy)	Quantity standard deviation of low copy number				

The calculation states that the average copy number of the larger (10,000 for reaction plates or 1600 for TLDA) unknown population minus three standard deviations is greater than the average copy number of the smaller (5000 for reaction plates or 800 for TLDA) unknown population plus three standard deviations. If the calculation is true, then the instrument passes the validation specification, verifying instrument performance.

Notes _____

Calculating the Results

1. In the Results Table of the plate document window, locate and record the average copy number (**Qty mean**) and standard deviation (**Qty std dev**) for the two unknown populations.

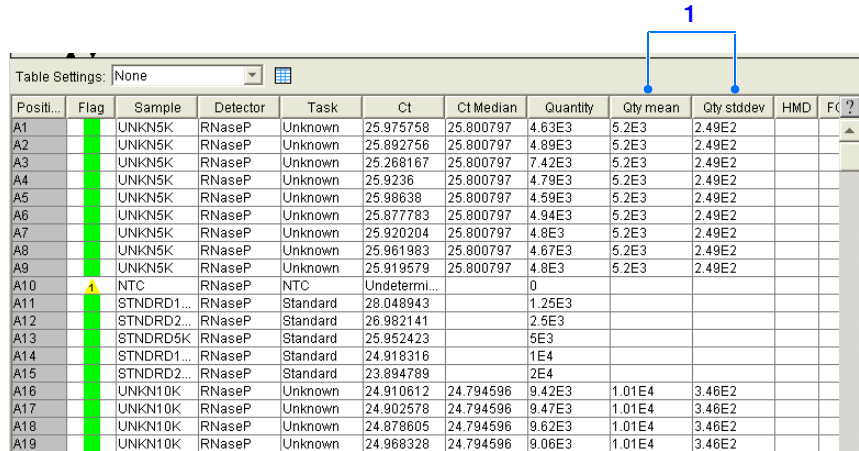

Table Settings: None

Positi...	Flag	Sample	Detector	Task	Ct	Ct Median	Quantity	Qty mean	Qty stddev	HMD	F(?)
A1		UNKN5K	RNaseP	Unknown	25.975758	25.800797	4.63E3	5.2E3	2.49E2		
A2		UNKN5K	RNaseP	Unknown	25.892756	25.800797	4.89E3	5.2E3	2.49E2		
A3		UNKN5K	RNaseP	Unknown	25.268167	25.800797	7.42E3	5.2E3	2.49E2		
A4		UNKN5K	RNaseP	Unknown	25.9236	25.800797	4.79E3	5.2E3	2.49E2		
A5		UNKN5K	RNaseP	Unknown	25.98638	25.800797	4.59E3	5.2E3	2.49E2		
A6		UNKN5K	RNaseP	Unknown	25.877783	25.800797	4.94E3	5.2E3	2.49E2		
A7		UNKN5K	RNaseP	Unknown	25.920204	25.800797	4.8E3	5.2E3	2.49E2		
A8		UNKN5K	RNaseP	Unknown	25.961983	25.800797	4.67E3	5.2E3	2.49E2		
A9		UNKN5K	RNaseP	Unknown	25.919579	25.800797	4.8E3	5.2E3	2.49E2		
A10		NTC	RNaseP	NTC	Undetermi...		0				
A11		STNDRD1...	RNaseP	Standard	28.048943		1.25E3				
A12		STNDRD2...	RNaseP	Standard	26.982141		2.5E3				
A13		STNDRD5K	RNaseP	Standard	25.952423		5E3				
A14		STNDRD1...	RNaseP	Standard	24.918316		1E4				
A15		STNDRD2...	RNaseP	Standard	23.894789		2E4				
A16		UNKN10K	RNaseP	Unknown	24.910612	24.794596	9.42E3	1.01E4	3.46E2		
A17		UNKN10K	RNaseP	Unknown	24.902578	24.794596	9.47E3	1.01E4	3.46E2		
A18		UNKN10K	RNaseP	Unknown	24.878605	24.794596	9.62E3	1.01E4	3.46E2		
A19		UNKN10K	RNaseP	Unknown	24.968328	24.794596	9.06E3	1.01E4	3.46E2		

2. Insert the values into the specification calculation:

$$(\text{Qty Unk}_{(\text{high copy})}) - 3 (\text{Qty } \sigma_{(\text{high copy})}) > (\text{Qty Unk}_{(\text{low copy})}) + 3 (\text{Qty } \sigma_{(\text{low copy})})$$

3. Determine whether the specification calculation is true or false.
 - If the calculation is true, the 7900HT Fast System passes the validation specification. Instrument performance is verified.
 - If the calculation is false, the 7900HT Fast System fails the validation specification. The instrument performance cannot be verified.

Notes _____



Notes _____



Chapter 1 Performing Calibration and Verification Runs
Performing an Instrument Verification Run

Notes _____

2

Maintaining the 7900HT Instrument Hardware

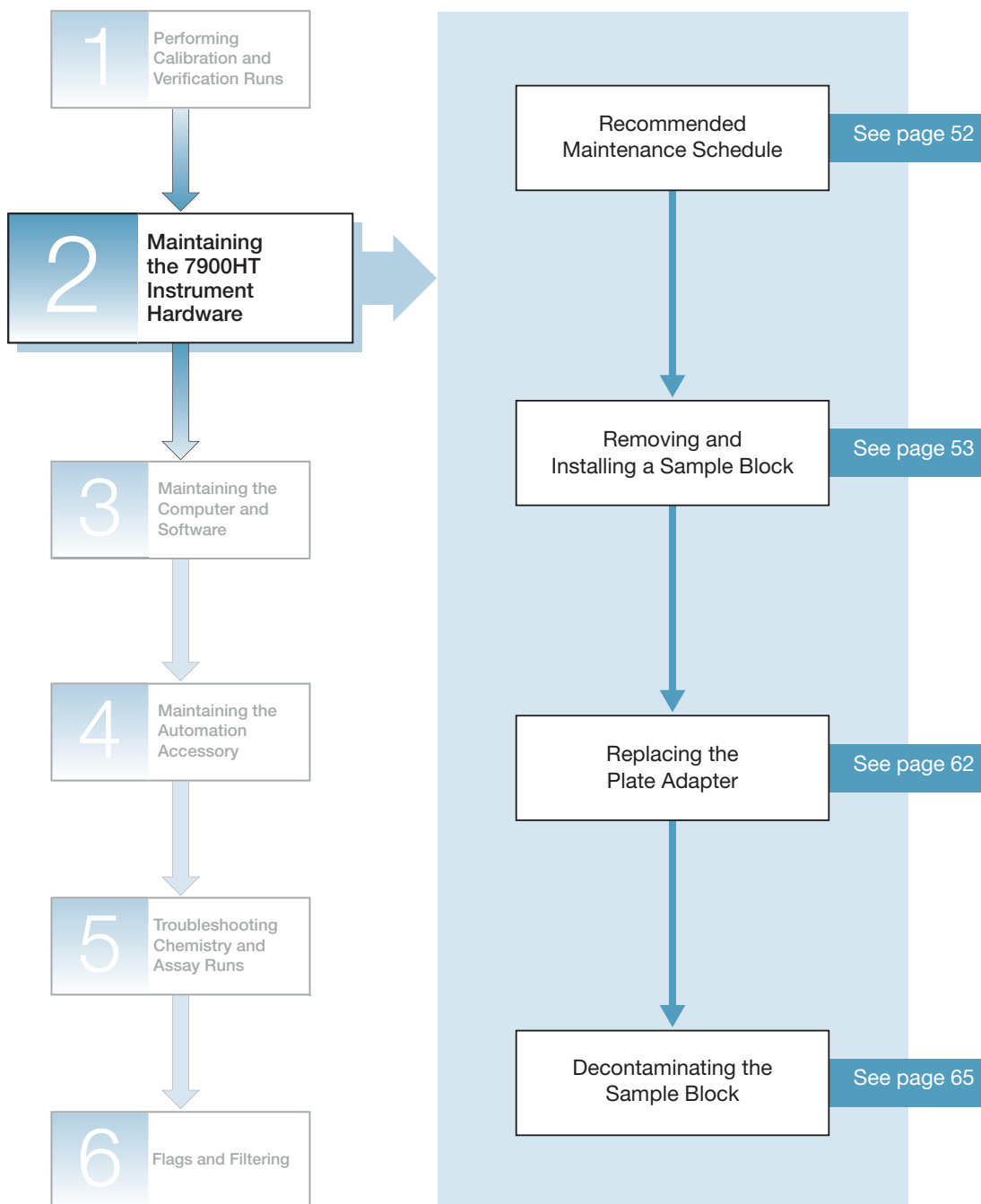

2

Notes

Recommended Maintenance Schedule

To ensure optimal performance of your 7900HT Fast System, perform the following tasks as indicated in the table below.

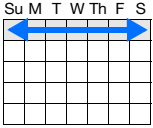
Schedule	Maintenance Task
<p>Weekly</p>  <p>Week (7 Days)</p>	<ul style="list-style-type: none"> • Cycle the computer and instrument power (power off, then power on the computer and instrument) • Wipe instrument surfaces with a lint-free cloth <p>IMPORTANT! Never use organic solvents to clean the 7900HT Fast System.</p>
As needed	<ul style="list-style-type: none"> • Remove and install a sample block (see page 53) • Replace the plate adapter (see page 62) • Decontaminate the sample block (see page 65)

Notes _____

Removing and Installing a Sample Block

When to Perform You need to remove/install a sample block when you:

- Decontaminate the wells of the sample block (see [page 65](#))
- Change sample blocks

Before You Begin

Time Required 15 minutes. The time will be longer if you have to perform background or pure dye calibrations, or if you have an Automation Accessory.

Materials Required You need the materials listed below to perform this procedure.

5/32 inch hex key

Note: Some instruments require the 5/32-inch hex key to remove the sample block locking bar. Other instruments have only a thumbscrew securing the sample block locking bar to the instrument chassis.



5/16 inch hex key

Note: Some instruments may require a crescent wrench rather than the 5/16-inch hex key.



If you are replacing the sample block, one of the following:

- 7900HT System Standard 384-Well Block
- 7900HT System Standard 96-Well Block
- 7900HT System Fast 96-Well Block
- 7900HT System TaqMan[®] Low Density Array Block

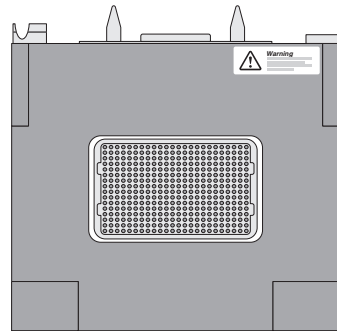

Workflow To remove/install the sample block:

1. Be sure all required upgrades to the SDS software and 7900HT instrument firmware are installed (see [page 83](#)).

IMPORTANT! Failure to upgrade the software and firmware can make the instrument inoperable or result in damage to instrument components.

2. Obtain the tools and materials required (shown above).
3. Review the sample block handling information (see [page 55](#)).

Notes

4. Remove the sample block (see [page 56](#)).
5. Reinstall the same sample block or install a new sample block (see [page 58](#)).
6. After the sample block is successfully installed, perform a background calibration (see [page 3](#)) to verify that the sample block:
 - Is connected and working properly
 - Contains no contaminants that will interfere with fluorescent detection

IMPORTANT! Perform a background calibration after installing the sample block, even if you are reinstalling the same sample block or replacing it with another block of the same format.

If you installed a new, uncalibrated sample block, also do the following:

7. Change the plate adapter (see [page 62](#)).
8. Perform a pure dye calibration to create the pure dye calibration values for the new sample block (see [page 17](#)).
9. Perform a verification run to confirm the proper operation of the new sample block (see [page 32](#)).

If you are using an Automation Accessory, also do the following:

10. If you changed sample block formats (for example, replacing a Standard 384-Well Block with a Fast 96-Well Block), adjust the plate sensor switch on the Zymark[®] Twister Microplate Handler arm for the new plate format (see [page 92](#)).
11. Align the Plate Handler for the new plate format (see [page 97](#)).
12. Align the fixed-position bar code reader for the new plate format (see [page 110](#)).

Notes _____

Handling the Sample Block

The interchangeable sample blocks are delicate pieces of equipment containing several fragile components that can break if handled improperly. The figure below shows the correct locations for handling the interchangeable sample blocks.

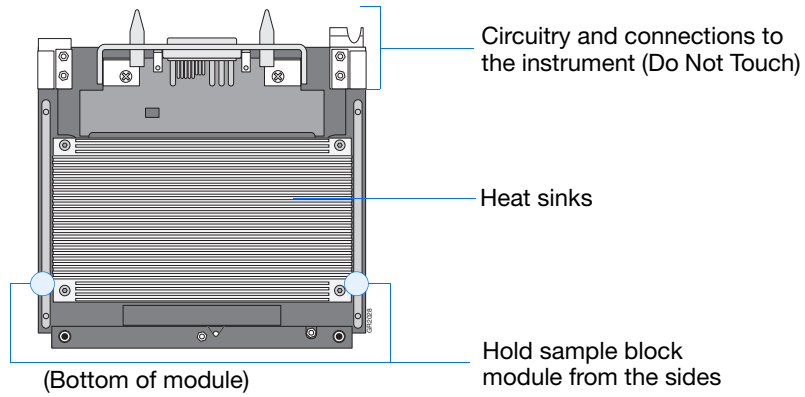

Notes _____

Removing the Sample Block

1. Confirm the function of the current module:

Note: If you do not have the SDS Automation Controller software, skip to [step 2](#) below.

- a. Double-click  on the desktop (or select **Start > All Programs > Applied Biosystems > SDS 2.3 > SDS Automation Controller 2.3**) to start the Automation Controller Software.
- b. Select the **Run Status** tab. The module is operating normally if the software is receiving a temperature reading.
- c. Click **Open/Close Door** to rotate the instrument tray to the OUT position.
- d. Select **File > Exit** to close the Automation Controller Software.

2. Power off and unplug the 7900HT instrument.



WARNING PHYSICAL HAZARD.

The instrument must be unplugged and powered off at all times during the following procedure. Failure to comply can result in serious physical injury to the user or damage to the instrument.

3. Wait 20 to 30 min for the heated cover to cool.



WARNING PHYSICAL HAZARD.

During instrument operation, the temperature of the sample block can be as high as 100 °C. Before performing this procedure, wait until the sample block reaches room temperature.

4. If the instrument tray is in the OUT position (outside of the instrument), push it into the instrument to provide an open workspace.

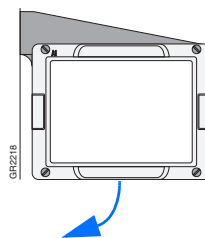

Notes _____

5. If using a Plate Handler, remove the covers for the fixed-position bar code reader and the underlying platform.

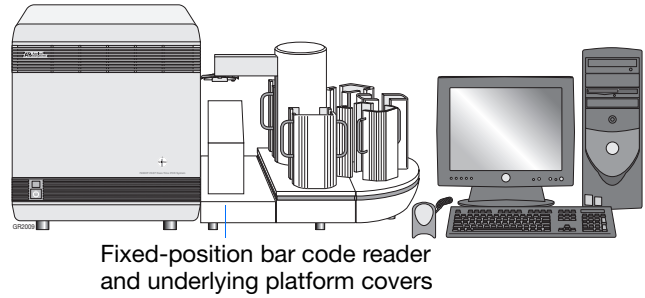

6. Push the instrument tray inside the instrument, then remove the thermal cycler access cover to permit access to the sample block.

IMPORTANT! The thermal cycler access cover is secured to the instrument by non-locking pins and may require force to remove it (no tools are required).

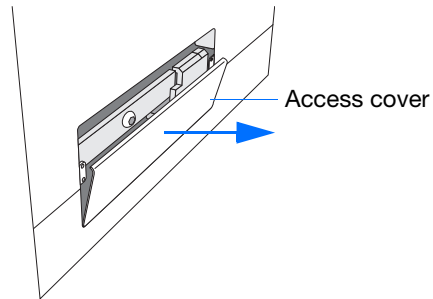

7. Using a 5/16-inch hex key, turn the sample block locking bolt counter-clockwise until it is very loose but still attached to the sample block locking bar.

IMPORTANT! Some instruments may require the use of an adjustable crescent wrench to loosen the sample block locking bolt.

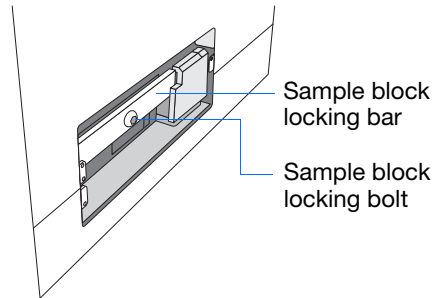

8. Loosen the thumbscrew securing the sample block locking bar to the instrument chassis (may be a 5/32-inch hex bolt on some instruments).

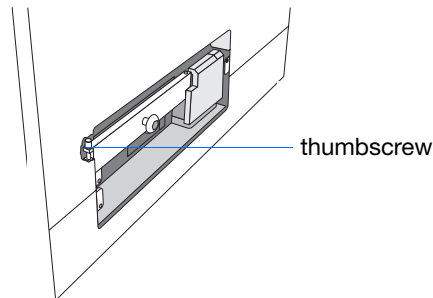

Notes _____

9. Lift the sample block locking bar up and out of the instrument.

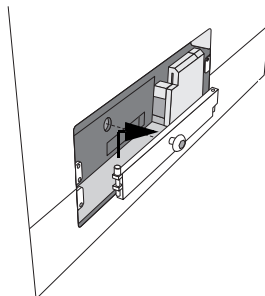

10. Remove the sample block from the instrument:

- a. Rotate the release lever at the base of the sample block 90 degrees.
- b. Being careful not to damage the heat sinks on the bottom of the sample block, slide the sample block out of the instrument and place it on a clean, level surface.

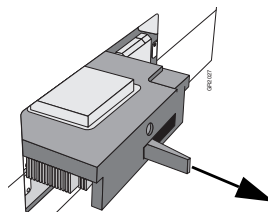
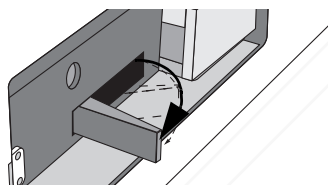

Installing a Sample Block

IMPORTANT! Before installing the sample block, perform all required upgrades to the SDS software and instrument firmware. Failure to upgrade the software and firmware can render the instrument inoperable or result in damage to instrument components.

1. Load the sample block into the instrument compartment:
 - a. Being careful not to damage the heat sinks on the bottom of the sample block, rest the sample block on the metal runners on either side of the instrument bay.

Notes _____

- b. Carefully slide the sample block into the instrument until the front of the block is flush with the rear of the locking bar.
- c. After it is seated, firmly press on the sample block to ensure a good connection.

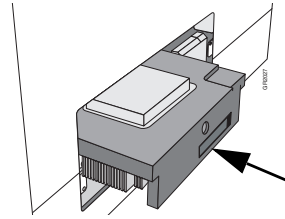

2. Replace the sample block locking bar.

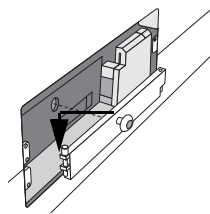

3. Tighten the thumbscrew (from [step 8 on page 57](#)) to secure the sample block locking bar to the instrument chassis (may be a 5/32-inch hex bolt).

4. Using the 5/16-inch hex key, turn the sample block locking bolt clockwise until it is flush with the locking bar.

5. Again, press on the right and left sides of the front surface of the sample block to ensure that it is seated securely.

6. Replace the thermal cycler access cover:

- a. Fit the lip at the bottom of the access cover over the lower edge of the bay.
- b. Push the cover towards the instrument until it snaps into place.

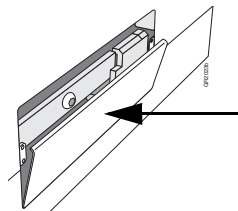

IMPORTANT! You must reinstall the thermal cycler access cover before powering on the instrument. Failure to do so prevents power from being applied to the thermal cycler electronics, heated clamp motor, and laser safety interlocks.

Notes

7. If using a Plate Handler, replace the covers for the fixed-position bar code reader and the underlying platform (removed in [step 5 on page 57](#)).

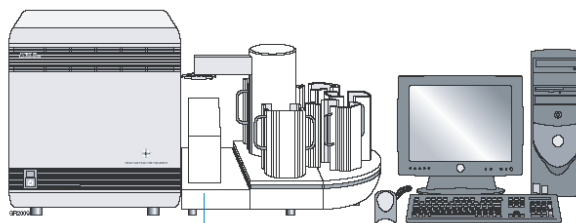

Fixed-position bar code reader and underlying platform covers

8. Plug in and power on the 7900HT instrument.
9. Confirm the function of the installed sample block:

Note: If you do not have the SDS Automation Controller software, skip this step.

- a. Double-click  on the desktop (or select **Start > All Programs > Applied Biosystems > SDS 2.3 > SDS Automation Controller 2.3**) to start the Automation Controller Software.

Notes _____

- b. Select the **Run Status** tab. The sample block is operating normally if the software is receiving a temperature reading.

Does the software display temperatures?	Then...
Yes	the installation is successful. The presence of temperature readings confirm that the 7900HT instrument successfully established the connection to the new sample block.
No	the 7900HT instrument is unable to establish communication with the new sample block. To troubleshoot the problem: <ol style="list-style-type: none">1. Power off and unplug the 7900HT instrument.2. Remove the thermal cycler access cover.3. Press on the right and left sides of the front plate of the sample block to ensure that it is seated securely.4. Reinstall the thermal cycler access cover.5. Repeat step 8 and step 9 on page 60 until you hear a high-pitched tone confirming communication between the instrument and sample block.

Notes _____

Replacing the Plate Adapter

When to Perform Replace the 7900HT instrument plate adapter after:

- Changing the sample block format (for example, replacing a Standard 384-Well Block with a Fast 96-Well Block)

Note: The sample block must be used with a corresponding plate adapter (that is, both the sample block and the plate adapter must have the same plate format).

Before You Begin

Time Required 5 to 10 minutes

Materials Required

You need the materials listed below to perform this procedure.

Flat-blade screwdriver

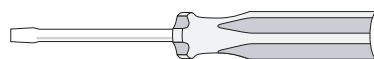

One of the following:





- 384-Well Plate Adapter
- 96-Well Plate Adapter
- Fast 96-Well Plate Adapter
- TaqMan® Low Density Array Adapter

Workflow To replace the plate adapter:

1. Obtain the tools and materials required (shown above).
2. Replace the plate adapter (see [page 63](#)).

Notes _____

Replacing the Plate Adapter

1. If the instrument tray is inside the 7900HT instrument, move the instrument tray to the OUT position:
 - a. Double-click  on the desktop (or select **Start > All Programs > Applied Biosystems > SDS 2.3 > SDS 2.3**) to start the SDS software.
 - b. Click  (or select **File > New**).
 - c. In the New Document dialog box, click .
 - d. In the new plate document, select the **Instrument > Real-Time** tabs.
 - e. Click .
 - f. The instrument tray rotates to the OUT position.
 - g. Select **File > Exit** to close SDS software.
2. Remove the four screws attaching the plate holder to the plate arm.

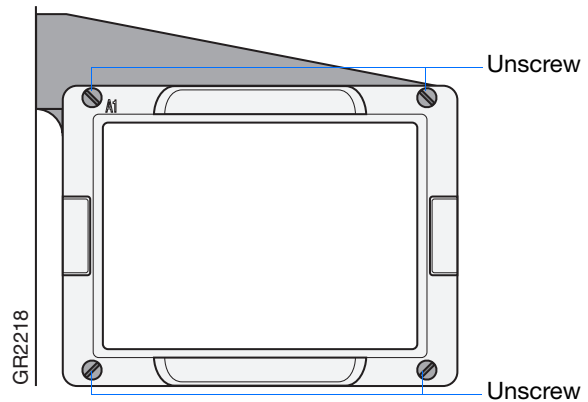

3. Remove the plate adapter from the instrument tray.

Note: If changing sample block formats (for example, replacing a Standard 384-Well Block with a Fast 96-Well Block), store the plate adapter with the sample block of the same format.

Notes

- Place the new plate adapter into the instrument tray with the A1 label in the rear-left corner.

IMPORTANT! Make sure to install the correct version of the plate adapter for the plate format you intend to use. The plate adapters are labeled with the format they support.

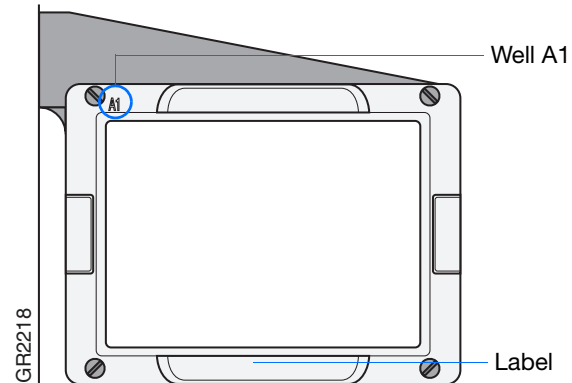

- Replace and tighten the four screws in the order shown.

IMPORTANT! The order in which the screws are tightened is important to ensure proper alignment of the plate to the sample block inside the 7900HT instrument.

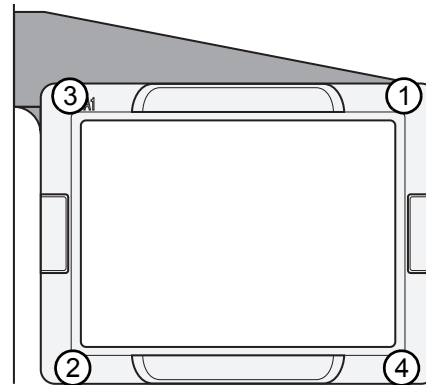

Notes _____

Decontaminating the Sample Block

Overview

This section describes how to decontaminate the wells of a sample block. The procedure eliminates residual PCR-related products, including fluorescent labeled TaqMan[®] probes.

Using Other Methods

IMPORTANT! If you plan to use a decontamination method other than the one in this guide, check with Applied Biosystems first to ensure that the method will not damage the sample block or the 7900HT instrument.

When to Perform

Decontaminate the sample block as often as needed.



Note: Decontamination is generally performed to resolve problematic background calibrations, where one or more wells consistently exhibit abnormally high signals indicating the presence of a fluorescent contaminant.

Before You Begin

Time Required 30 minutes. The time may vary, depending on the extent of the contamination.

Materials Required

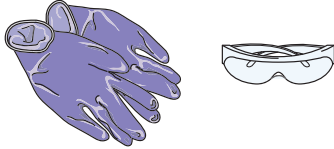
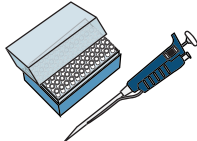
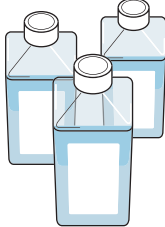
You need the materials listed below to perform this procedure.

Powder-free gloves and safety goggles	
Pipettors and pipet tips (100- μ L)	
10% Sodium hypochlorite (bleach) solution Water, deionized Isopropanol, 100 percent pure	
Cotton swabs and lint-free cloths	

Notes

Workflow To decontaminate the sample block:

1. Remove the sample block from the 7900HT instrument (see [page 53](#)).
2. Obtain the tools and materials required for decontamination (shown above).
3. Decontaminate the sample block:
 - For a Standard 384-Well Block, Standard 96-Well Block, or Fast 96-Well Block, see [page 67](#)
 - For a TaqMan[®] Low Density Array Block, see [page 70](#)
4. Replace the sample block (see [page 58](#)).
5. Perform a background calibration to confirm that the contamination has been removed (see [page 3](#)).

Notes _____

Decontaminating a Sample Block

This procedure applies to a:

- Standard 384-Well Block
- Standard 96-Well Block
- Fast 96-Well Block

1. Suspected contaminated wells are those that give a signal >4000 FSU during a background calibration (see [page 14](#)). Using the SDS software, isolate the suspected contaminated wells as explained on [page 15](#).
2. Locate the suspected contaminated wells on the sample block, using the figure at right as a guide.

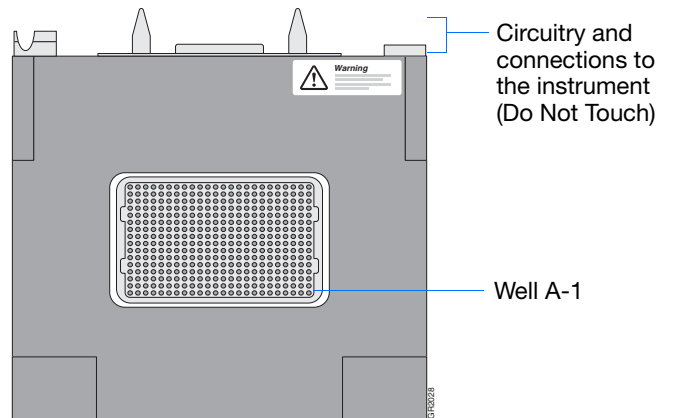

Notes _____

3. Rinse (pipet and remove) each contaminated well with three treatments of deionized water at the appropriate volume for the sample block:
 - 40 μL per well for a Standard 384-Well Block
 - 150 μL per well for a Standard 96-Well Block
 - 55 μL per well for a Fast 96-Well Block

Note: Absolute isopropanol can be substituted for water in the third treatment.

**WARNING CHEMICAL HAZARD.**

Isopropanol is a flammable liquid and vapor. It may cause eye, skin, and upper respiratory tract irritation. Prolonged or repeated contact may dry skin and cause irritation. It may cause central nervous system effects such as drowsiness, dizziness, and headache, etc. Please read the MSDS, and follow the handling instructions. Wear appropriate protective eyewear, clothing, and gloves.

4. Using a cotton swab, scrub inside of each contaminated well.

Note: If you are decontaminating a Standard 384-Well Block, remove some of the cotton from the swab tip; this allows the swab to reach the bottom of the wells.

5. Using a lint-free cloth, absorb the excess deionized water or isopropanol from the wells.

Notes _____

6. Pipet the appropriate volume of 10% bleach solution into each suspected contaminated well:
 - 40 μL per well for a Standard 384-Well Block
 - 150 μL per well for a Standard 96-Well Block
 - 55 μL per well for a Fast 96-Well Block



WARNING CHEMICAL HAZARD. Sodium hypochlorite (bleach) is a liquid disinfectant that can be corrosive to the skin and can cause skin depigmentation. Please read the MSDS, and follow the handling instructions. Wear appropriate protective eyewear, clothing, and gloves.

7. Allow the sample block to sit for 3 to 5 min.
8. Using a pipet, remove the bleach solution from the wells.
9. Rinse (pipet and remove) the wells with deionized water at the appropriate volume for the sample block:
 - 40 μL per well for a Standard 384-Well Block
 - 150 μL per well for a Standard 96-Well Block
 - 55 μL per well for a Fast 96-Well Block
10. Using a lint-free cloth, absorb the excess deionized water from the wells.

Notes _____

Decontaminating a TLDA Block

This procedure applies to the TaqMan Low Density Array Block.

1. Using a lint-free cloth, wipe the surface of the sample block (grey aluminum) with 10% bleach.



WARNING CHEMICAL HAZARD.

Sodium hypochlorite (bleach) is a liquid disinfectant that can be corrosive to the skin and can cause skin depigmentation. Please read the MSDS, and follow the handling instructions. Wear appropriate protective eyewear, clothing, and gloves.

2. Wipe the sample block three times with distilled water.
3. Wipe the sample block with isopropanol.



WARNING CHEMICAL HAZARD.

Isopropanol is a flammable liquid and vapor. It may cause eye, skin, and upper respiratory tract irritation. Prolonged or repeated contact may dry skin and cause irritation. It may cause central nervous system effects such as drowsiness, dizziness, and headache, etc. Please read the MSDS, and follow the handling instructions. Wear appropriate protective eyewear, clothing, and gloves.

4. Allow the sample block to air dry.

Notes _____

3

Maintaining the Computer and Software

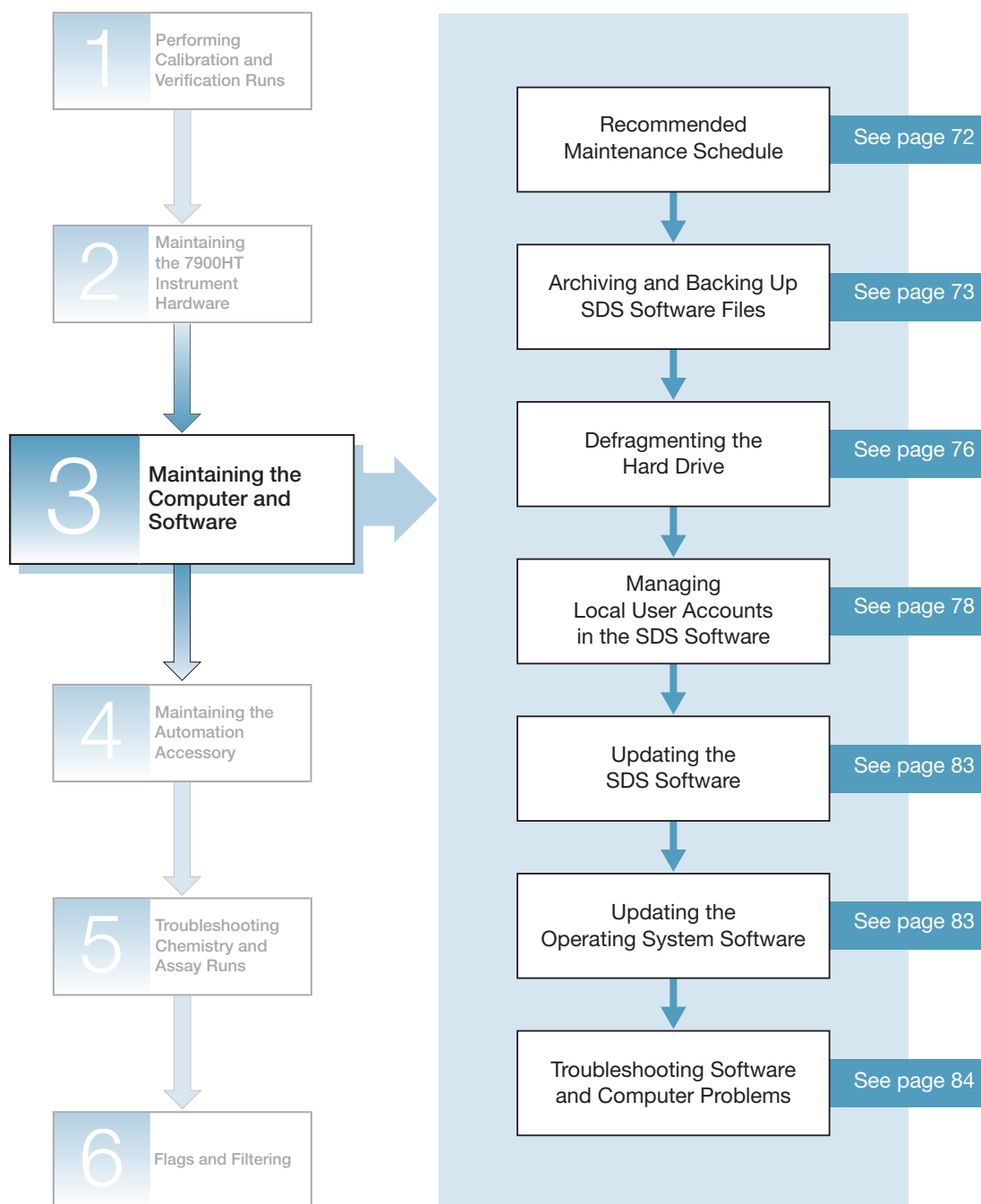

Notes

Recommended Maintenance Schedule

To ensure optimal performance of your 7900HT Fast System, perform the following tasks as indicated in the table below.

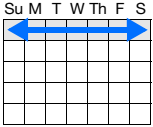
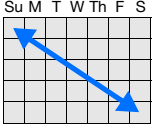
Schedule	Maintenance Task
<p>Weekly</p>  <p>Week (7 Days)</p>	Archive or backup SDS plate document files (see page 73)
<p>Monthly</p>  <p>Month (30 Days)</p>	Defragment the computer hard drive (see page 76)
As needed	<ul style="list-style-type: none"> • Manage local user accounts in the SDS software (see page 78) • Update the SDS software (see page 83) • Update the operating system software (see page 83)

Notes _____

Archiving and Backing Up SDS Software Files

When to Perform Weekly

Archiving SDS Software Files

To conserve space on the computer hard drive, SDS software files can be archived using a data compression utility. A compression utility typically archives files by encoding the binary data they contain algorithmically, thereby reducing the size of a file.

Several commercially available compression utilities are available. PKZIP and *.arc are archive formats common to the Microsoft Windows® operating system.

Backing Up SDS Software Files

Applied Biosystems strongly recommends that you back up the data generated by your 7900HT Fast System for two reasons:

- Backing up data protects against potential loss of data caused by an unforeseen failure of the computer or its hard drive(s).
- Backing up older data and removing it from the computer hard drive conserves space on the hard drive and optimizes performance.

Choosing a Backup Storage Device

Applied Biosystems recommends the use of one or more backup storage devices to prevent potential loss of data caused by unforeseen failures of the computer or its hard drive(s).

The CD-RW drive of the computer can serve as the backup storage device for your system. By saving your *.sds and *.sdt files to one or more writable CDs on a weekly basis, you can effectively backup the data generated by your 7900HT Fast System.

Developing a Data Management Strategy

Applied Biosystems recommends developing a strategy for dealing with the files produced by the SDS software. During a single day of real-time operation, the 7900HT System can generate over 200 MB of data. Without a strategy for distributing and archiving SDS software files, the 7900HT instrument can easily fill the hard drive of the computer within just a few weeks of operation.

If you are performing real-time experiments on your 7900HT Fast System, check the amount of available space on your hard drive weekly. When the hard drive is within 20% of its capacity, transfer the older data to a backup storage device.

Note: Real-time experiments include standard curve (AQ) assays and comparative C_T (RQ) assays, as well as any amplification (AQ) runs you might perform on the 7900HT System for allelic discrimination assays or plus/minus assays.

To successfully manage the information produced by the 7900HT System, you should have a basic understanding of how data is collected, stored, and processed throughout the operation of the instrument. See “[Modes of Operation](#)” on page 74.

Notes _____

Modes of Operation

System Operation and Dataflow

Data management strategy is a crucial element of successfully integrating the Applied Biosystems 7900HT Fast Real-Time PCR System into a laboratory workflow. During a single 24-hour period of real-time operation, the 7900HT instrument can produce more than 200 MB of data. To successfully manage the information produced by the 7900HT System, you should have a basic understanding of how data is collected, stored, and processed throughout the operation of the instrument.

Standard Modes of Operation

The 7900HT Fast System has two standard modes of operation, depending on the accessories purchased with the base instrument:

- [Stand-Alone Operation](#) (see below)
- [Automated Operation](#) (see [page 75](#))

Stand-Alone Operation

In this mode (the most basic configuration of the 7900HT Fast System), the 7900HT instrument is used without any additional components. In this configuration (see the figure below), a technician runs plates individually using the SDS software. The computer stores all data for instrument operation and provides the software for analyzing the run data.

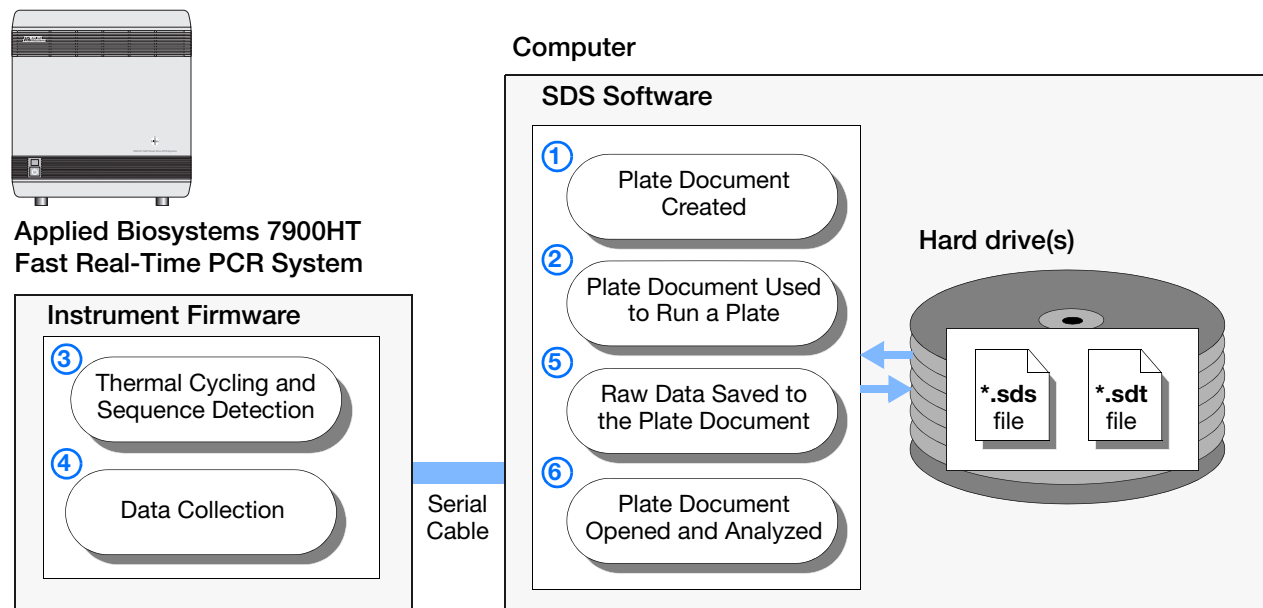

Notes

Automated Operation

In this mode, the 7900HT Fast System uses an Automation Accessory (Zymark® Twister Microplate Handler and fixed-position bar code reader) to provide high-throughput operation suitable for small- to medium-scale studies. With this configuration (see the figure below), a technician can use the Automation Controller Software to run batches of plates unattended. As in Stand-Alone mode, the computer stores all data for instrument operation and provides the software for analyzing the run data.

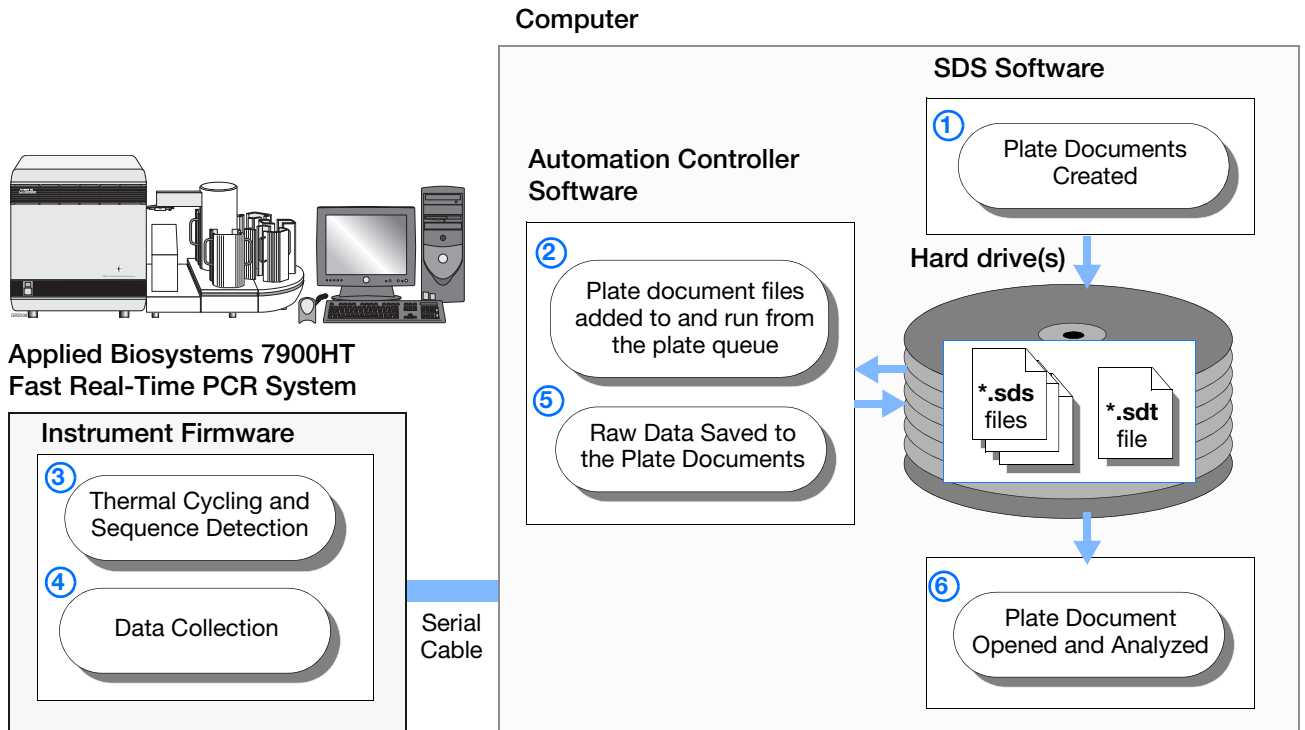

Notes _____

Defragmenting the Hard Drive

When to Perform

- At least once every month
- Before fragmentation reaches 10% (or when warned by the Windows operating system)

Purpose: Why Defragment the Hard Drive?

As the 7900HT Fast System is used and files are deleted and created, the free space on the computer hard drive eventually is split into increasingly smaller blocks. Consequently, as the SDS software creates new files and extends old ones, the computer cannot store each file in a single block. Instead, the system will ‘fragment’ the files by scattering their component pieces across different sectors of the hard drive.

The fragmentation of SDS files decreases the performance of both the SDS software and the computer operating system. As the hard drive becomes fragmented, programs take greater time to access files because they must perform multiple seek operations to access the fragments. Defragmentation utilities defragment broken files by combining their component pieces at a single location on the hard drive, thereby optimizing system performance.

Notes _____

Defragmenting the Hard Drive

1. In the Windows desktop, select  **My Computer**.
2. In the My Computer window, right-click a hard drive and select **Properties**.

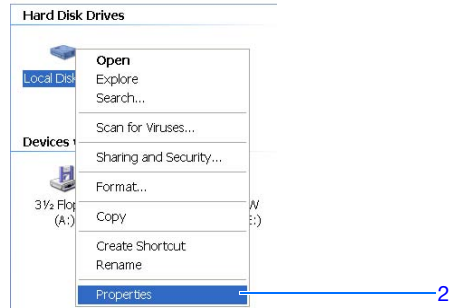

3. In the Local Disk Properties dialog box:
 - a. Select the **Tools** tab.
 - b. Click to open the Disk Defragmenter dialog box.

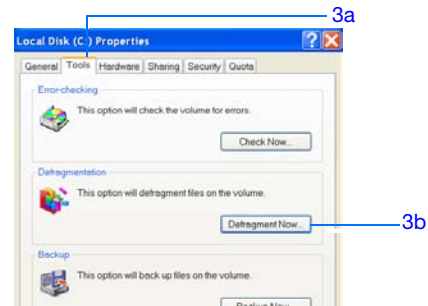

4. Click .

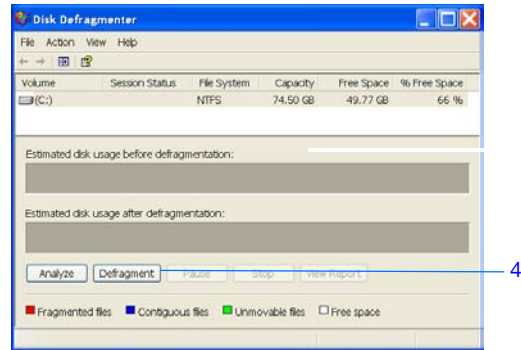

5. When the Defragmentation Complete dialog box displays, click .
6. In the Local Disk Properties dialog box, click .
7. Repeat [steps 2 through 6](#) for the remaining drives on the computer.

Notes

Managing Local User Accounts in the SDS Software

Managing local user accounts includes the following:

- Enabling or disabling the SDS software login function ([page 79](#))
- Adding user accounts ([page 79](#))
- Editing user accounts ([page 81](#))
- Deleting user accounts ([page 82](#))

Non-Enterprise Mode Only

This section applies to the SDS software in non-Enterprise mode (that is, the SDS software does not include the SDS Enterprise Database). For versions of the SDS software that do include the SDS Enterprise Database, user accounts are managed with the SDS User Account Manager software. For more information, see the *SDS Enterprise Database for the Applied Biosystems 7900HT Fast Real-Time PCR System Administrators Guide*.

When to Perform As needed

Notes _____

Enable/Disable Login

Enabling the login function allows the SDS software to capture user information so that the system can be customized for each user (user preferences).

When the login is enabled, the Login dialog box appears when the SDS software is started.

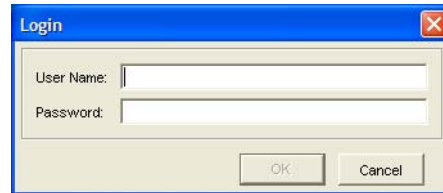

To enable or disable the login:

1. Double-click  on the desktop (or select **Start > All Programs > Applied Biosystems > SDS 2.3 > SDS 2.3**) to start the SDS software.
2. Select **Tools ▶ Options** to open the Options dialog box.
3. Click the **General** tab.
4. Select or deselect the **Enable login in non-enterprise mode** check box, as desired.
5. Click **OK** to save the changes and close the dialog box.

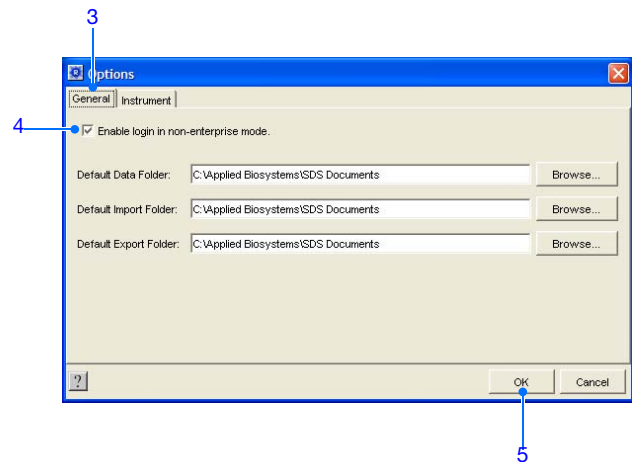

Add a User Account

1. Double-click  on the desktop (or select **Start > All Programs > Applied Biosystems > SDS 2.3 > SDS 2.3**) to start the SDS software.

Notes _____

2. Select **Tools ▶ Local User Account Manager** to open the Local User Account Manager dialog box.

3. Click **Add User**.

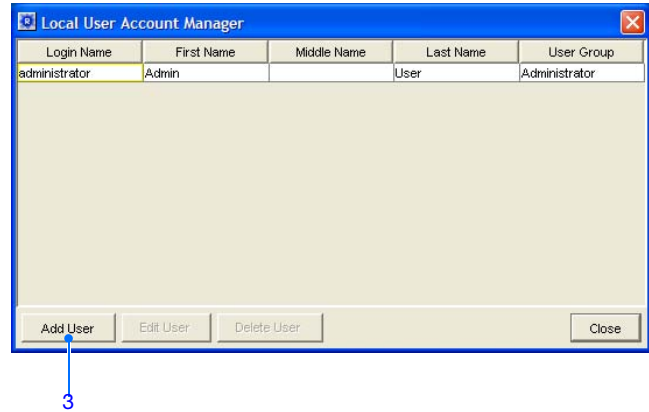

4. Complete the Add Local User dialog box:

- a. User Name – Enter a user name. The user name must begin with a letter of the alphabet and cannot exceed 30 characters.
- b. Password/Confirm Password – Enter a password, then re-enter it to confirm. The password must begin with a letter of the alphabet and must be between 6 and 30 characters long.

Note: Users can change their own passwords at a later time by selecting **Tools ▶ Change Password**.

- c. Full Name pane – Enter the user's First, Middle, and Last names. The names cannot exceed 50 characters.
- d. User Group pane – Select an appropriate group for the user: **Operator**, **Administrator**, or **Scientist**.

Note: This information is *not* used for access control purposes.

- e. Status pane – Select an appropriate status for the user: **Active** or **Disabled**.

Note: If a user has the Disabled status, the user cannot log into the software.

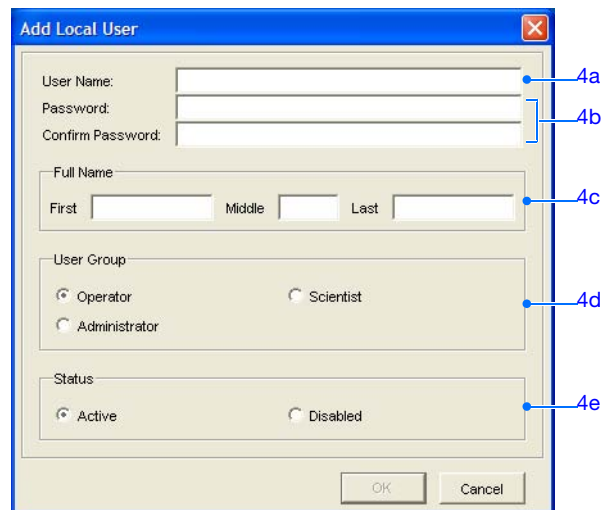

5. Click **OK** to save the changes and close the dialog box.

Notes _____

Edit a User Account

1. Double-click  on the desktop (or select **Start > All Programs > Applied Biosystems > SDS 2.3 > SDS 2.3**) to start the SDS software.
2. Select **Tools ▶ Local User Account Manager** to open the Local User Account Manager dialog box.
3. Select the user account you want to edit, then click **Edit User**.

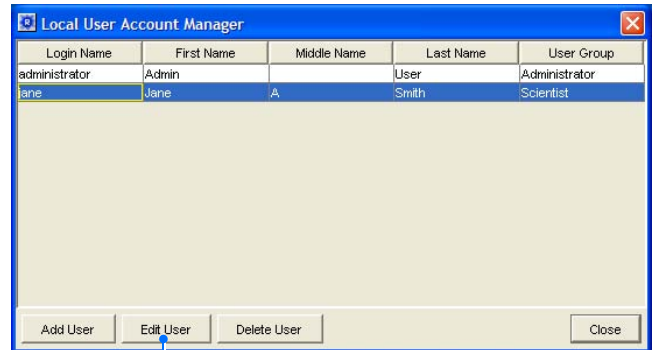

4. Complete the Edit Local User dialog box:
 - a. Full Name pane – Enter the user’s First, Middle, and Last names. The names cannot exceed 50 characters.
 - b. User Group pane – Select an appropriate group for the user: **Operator**, **Administrator**, or **Scientist**.

Note: This information is *not* used for access control purposes.

- c. Status pane – Select an appropriate status for the user: **Active** or **Disabled**.

Note: If a user has the Disabled status, the user cannot log into the software.

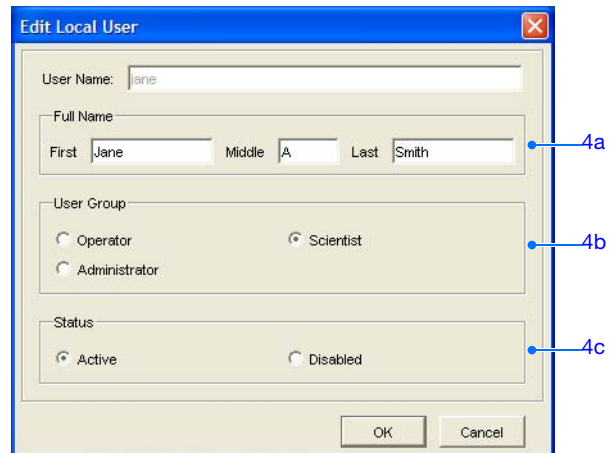

Note: You cannot edit a user’s name or password. Users can change their own passwords at a later time by selecting **Tools ▶ Change Password**.

5. Click **OK** to save the changes and close the dialog box.

Notes

Delete a User Account

1. Double-click  on the desktop (or select **Start > All Programs > Applied Biosystems > SDS 2.3 > SDS 2.3**) to start the SDS software.
2. Select **Tools ▶ Local User Account Manager** to open the Local User Account Manager dialog box.
3. Select the user account you want to delete, then click **Delete User**.
4. At the prompt, click **Yes**. The user account is removed from the Local User Account Manager.
5. Click **Close** to close the dialog box.

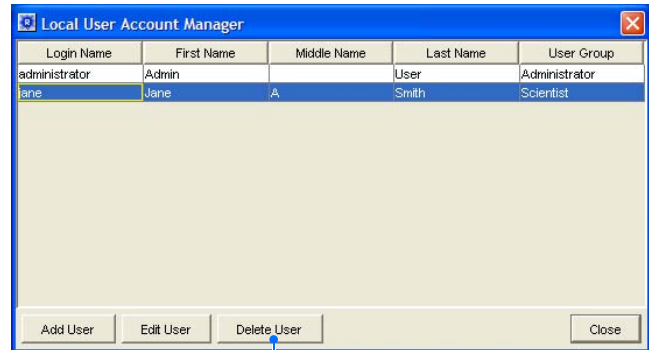

Notes _____

Updating the SDS Software

When to Perform As needed

Upgrading the SDS Software

Applied Biosystems continually develops the SDS software to provide increased functionality and reliability of the 7900HT Fast System. As updates become available, Applied Biosystems sends notifications of the upgrades to all Applied Biosystems 7900HT Fast System customers.

Review all documentation accompanying the software upgrade (such as installation notes or user bulletin). The updated version of the software may contain new features that require special consideration.

Note: Applied Biosystems service engineers perform regular SDS software updates during planned maintenance visits.

Reinstalling the SDS Software

On rare occasions, when a piece of the SDS software becomes corrupt, it may be necessary to reinstall the software. In the event that the software must be reinstalled, observe the following guidelines:

- Unless instructed to do otherwise, remove the SDS software using the uninstall utility. Do not delete the program folder from the Program Files directory.
- Backup all data before reinstalling the SDS software.
- Reinstall the SDS software under a user login that has administrator privileges on the computer.
- Unless instructed to do otherwise, reinstall the SDS software to the same directory as the previous installation.

Updating the Operating System Software

When to Perform Windows Service Pack Updates

Do not upgrade the operating system of the computer connected to the 7900HT Fast System unless instructed to do so by an Applied Biosystems representative. New versions of the Windows operating system can conflict with the SDS software and render the instrument inoperable.

If you want to install a service pack to update the operating system, check the release notes that are installed with the SDS software for compatibility issues.

Note: Applied Biosystems service engineers maintain the operating system software as part of planned maintenance visits. During the visit, an engineer will update the computer operating system as upgrades become available and are validated by Applied Biosystems.

Notes _____

Troubleshooting Software and Computer Problems

Troubleshooting Table

Table 3-1 Troubleshooting software and computer problems

Observation	Possible Cause	Recommended Action
<p>SDS software will not start</p> <p>The software crashes/freezes the computer or displays an error message</p>	<ul style="list-style-type: none"> • Incorrect start-up sequence • Corrupted software • Computer hardware failure • Operating System (OS) corruption • Loose bar code reader cable 	<p>Follow the solutions listed until the symptom goes away.</p>
		1
		<ol style="list-style-type: none"> 1. Power off the 7900HT instrument. 2. Check cable connections. 3. Restart the computer and log on to the computer. 4. Power on the 7900HT instrument. 5. Start the SDS software.
		2
		<ol style="list-style-type: none"> 6. Restart the computer and log on to your computer. 7. Reinstall the SDS software. 8. Start the SDS software.
		3
		<p>Contact Applied Biosystems Service for OS problems or if the computer will not boot up at all. You may have to reload the OS from the CDs.</p>
4		
<p>Contact Dell for troubleshooting the computer hardware.</p>		
Communication error	Cables are connected incorrectly	Check cable connections and COM port setup. See Appendix B on page 153 .
Thermal cycler errors	Sample block module not fully engaged	Reseat the sample block module. See “Removing and Installing a Sample Block” on page 53 .
Automation Controller Software cannot find a plate document file	File not in correct location	Remove file entry from plate queue and add the file to the plate queue again.

Notes _____

Table 3-1 Troubleshooting software and computer problems

Observation	Possible Cause	Recommended Action
Dialog box does not respond to mouse clicks or key strokes	Java Runtime Error	Click the close box of the dialog box to close it.
Run will not start	No calibration file	Perform background and pure dye calibrations. See “Performing a Background Calibration” on page 3 and “Performing a Pure Dye Calibration” on page 17.
	No background data in calibration file (background calibration has not been performed)	
	No pure dye data in calibration file (pure dye run has not been performed)	
	Calibration file does not contain pure dye data for a dye used on the plate document	
	Calibration file was created on another instrument	
	Disk drive containing the plate document has less than 50 MB of free space	Check the capacity of the destination drive. If less than 50 MB of free space remains, remove or archive existing data files. See “Archiving and Backing Up SDS Software Files” on page 73.
	Heated cover cannot reach running temperature because no plate loaded	Open the instrument tray and check that the instrument contains a plate.
	Instrument tray contains a plate	
	Output stack contains a plate or plates	Remove all plates from the output stack of the Plate Handler before starting the queue.
Computer is slow when analyzing data, opening or closing dialog boxes, and other software processes	Hard drive is fragmented	Defragment the hard drive. See “Defragmenting the Hard Drive” on page 76.
	Hard drive is almost full	Remove or archive existing data files. See “Archiving and Backing Up SDS Software Files” on page 73.

Notes _____

Table 3-1 Troubleshooting software and computer problems

Observation	Possible Cause	Recommended Action
The computer will not logon to the Windows operating system	Logon window does not appear	Restart the computer and log on to your computer.
	You are not logged on as the Administrator	<ol style="list-style-type: none"> 1. Log off of your computer. 2. Log on again as the Administrator.
	After the above solutions have been tried, the problem is still not fixed	Contact Dell for troubleshooting the computer hardware or OS.
The computer will not boot up at all	Cables are not connected or are not seated properly	Check the cables.
		The boot disk is corrupted. <ol style="list-style-type: none"> 1. Boot directly off of the Windows operating system installation CD. 2. Boot off of the emergency disk. 3. Reload the Windows operating system from the CD.
	After the above solution has been tried, the problem is still not fixed	Contact Dell for troubleshooting the computer hardware.

Notes _____

4

Maintaining the Automation Accessory

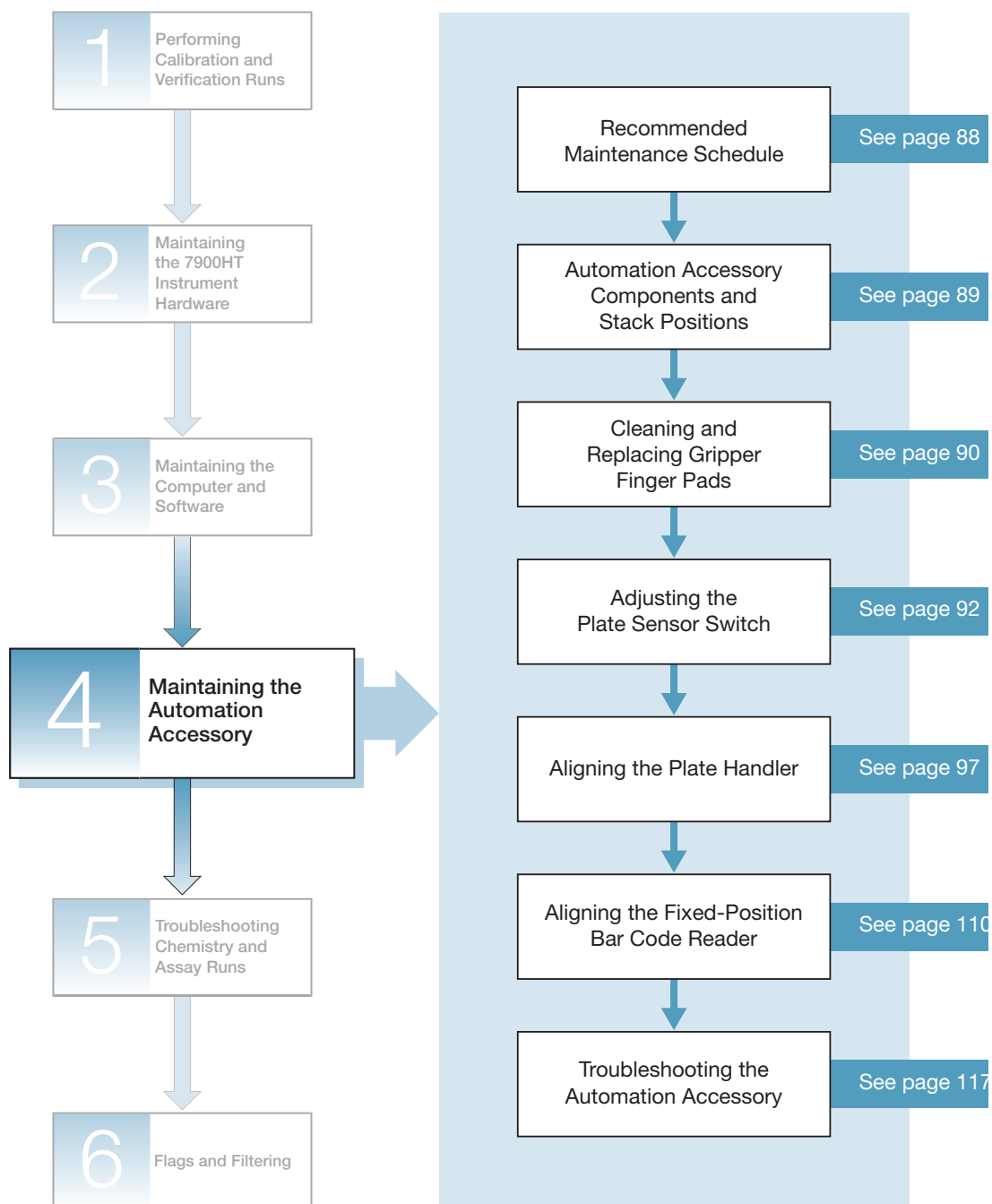

Notes

Recommended Maintenance Schedule

To ensure optimal performance of the Automation Accessory, perform the following tasks as indicated in the table below.

Schedule	Maintenance Task
<p>Monthly</p> <p>Month (30 Days)</p>	<p>Inspect the gripper finger pads (see page 90)</p>
<p>As needed</p>	<ul style="list-style-type: none"> • Clean or replace the gripper finger pads (see page 90) • Adjust the plate sensor switch (see page 92) • Align the Plate Handler (see page 97) • Align the fixed-position bar code reader (see page 110)

Notes _____

Automation Accessory Components and Stack Positions

Automation Accessory Components

The Automation Accessory includes the Zymark® Twister Microplate Handler and the fixed-position bar code reader.

Refer to the figure below for the components discussed in this section.

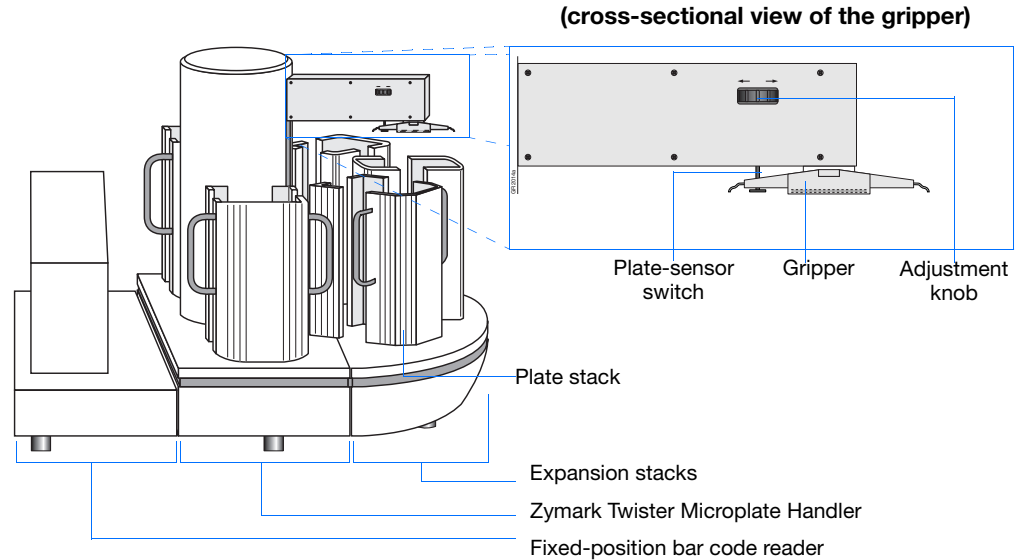
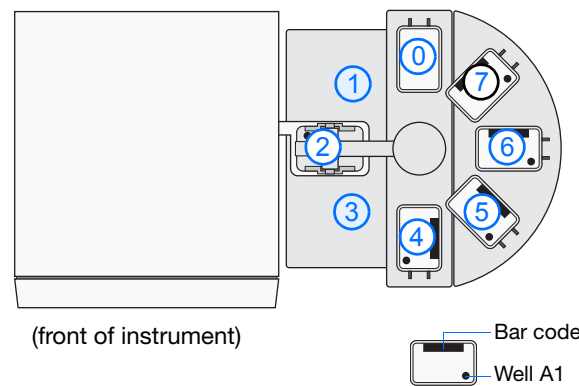

Plate Stack Positions

The Zymark Twister Microplate Handler alignment is performed using the Zymark® Twister Software. The software refers to the positions of the plate stacks differently than the Automation Controller Software. The figure below lists the positions defined by the Zymark Twister Software and the Automation Controller Software equivalents.



Zymark Twister Software	Automation Controller Software
Position 0	Output
Position 1	(unused)
Position 2	Instrument
Position 3	(unused)
Position 4	Stack 1

Notes

Cleaning and Replacing Gripper Finger Pads

When to Perform The adhesive used to affix bar code labels to certain brands of microplates can build up on the gripper pads of the Zymark Twister Microplate Handler. Over time, the residue can cause the gripper pads to stick to the microplates while handling them, causing misfeeds.



To prevent buildup, Applied Biosystems recommends that you:

- Inspect the gripper pads monthly
- Clean or replace the pads as needed

Before You Begin

Time Required 10 minutes

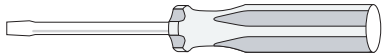
Materials Required You need the materials listed below to perform this procedure.

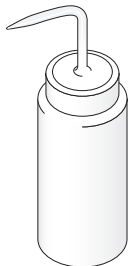
Finger Pad Replacement Kit, containing 10 finger pads (PN 4315472)	
Flat-blade screwdriver, small	
Phillips head screwdriver, small	
Isopropanol in a squeeze bottle	

Workflow To clean and replace the gripper finger pads:

1. Obtain the tools and materials required (shown above).
2. Clean (see below) or replace (see [page 91](#)) the gripper finger pads.

Notes _____

Cleaning the Finger Pads

1. Wipe each pad thoroughly with Isopropanol until the residue has been removed.



WARNING

CHEMICAL HAZARD. Isopropanol is a flammable liquid and vapor. It may cause eye, skin, and upper respiratory tract irritation. Prolonged or repeated contact may dry skin and cause irritation. It may cause central nervous system effects such as drowsiness, dizziness, and headache, etc. Please read the MSDS, and follow the handling instructions. Wear appropriate protective eyewear, clothing, and gloves.

2. If the pads appear rough or the adhesive cannot be removed, replace the pads as described on [page 91](#).

Replacing the Finger Pads

1. Using a small Phillips-head screwdriver, remove the two small Phillips-head screws from the fingers on each side of the gripper, then remove the fingers.

Note: Move the Plate Handler arm into any position where it is easy to access the screws.

2. Using a small flat-blade screwdriver, pry the worn finger pads off the fingers.

Note: The manufacturer recommends replacing all finger pads at the same time.

3. Clean any residual adhesive off the fingers using isopropanol.



WARNING

CHEMICAL HAZARD. Isopropanol is a flammable liquid and vapor. It may cause eye, skin, and upper respiratory tract irritation. Prolonged or repeated contact may dry skin and cause irritation. It may cause central nervous system effects such as drowsiness, dizziness, and headache, etc. Please read the MSDS, and follow the handling instructions. Wear appropriate protective eyewear, clothing, and gloves.

4. Remove a replacement finger pad from the paper backing, then place the finger pad on the appropriate finger position.

5. Repeat [step 4](#) for the remaining finger pads.

6. Install the fingers with the fingers pointing down and the finger pads toward the center of the gripper.

7. Insert the screws into the fingers and tighten.

Note: The screws do not automatically align the grippers. Make sure that the finger pads are making good contact with the plate when the Plate Handler arm grips a plate.

Notes _____

Adjusting the Plate Sensor Switch

When to Perform Adjust the plate sensor switch (located underneath the arm of the Plate Handler):

- After changing the sample block format (for example, replacing a Standard 384-Well Block with a Standard 96-Well Block)

Note: The Automation Accessory should not be used for running Fast 96-well reaction plates.

Note: The various plate types have different dimensions, which can affect the way the Plate Handler grips the plates. Adjusting the plate sensor switch after changing sample block formats ensures smooth operation of the Automation Accessory.

- If the Plate Handler is having difficulty sensing plates

Before You Begin

Time Required 20 minutes

Materials Required You need the materials listed below to perform this procedure.

Appropriate plate type for your current sample block; one of the following:

- Standard 384-well reaction plate
- Standard 96-well reaction plate
- TaqMan® Low Density Array

Note: The Automation Accessory should not be used for running Fast 96-well reaction plates.

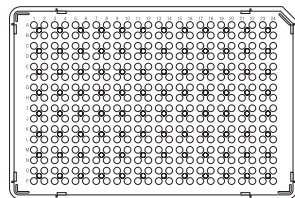

Pictured: Standard 384-well reaction plate

Workflow To adjust the plate sensor switch:

1. Obtain the tools and materials required (shown above).
2. Adjust the plate sensor switch (see [page 93](#)).
3. Test the adjustment (see [page 95](#)).
4. Confirm the Zymark Twister Software is closed (see [page 96](#)).

Notes _____

Adjusting the Plate Sensor Switch

1. Power off the Zymark Twister Microplate Handler.



WARNING PHYSICAL HAZARD.

The Zymark Twister Microplate Handler must be powered off at all times during the following procedure. Failure to comply can result in physical injury to the user or damage to the Plate Handler.

2. Clear the switch position by turning the thumb wheel all the way to the Up extreme (as indicated on the side panel).

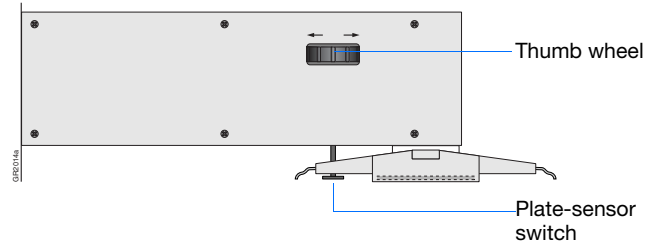

3. Begin the adjustment of the sensor switch:
 - a. Grasp a plate by the sides, making sure not to place pressure in the center of the plate to deform it.
 - b. Place the plate between the fingers of the gripper assembly and align it to the middle of the centering device.
 - c. While holding the plate in position, slowly turn the thumb wheel to lower the switch onto the plate until the switch:
 - Contacts the top of the plate, and
 - Emits a soft, audible “clicking” noise

IMPORTANT! The sound emitted by the sensor switch is very faint and may be difficult to hear. To make the adjustment easier, place your ear close to the sensor switch while making the adjustment and listen for the switch to engage.

Notes _____

4. Remove the plate and listen for the plate sensor switch to disengage.

Did you hear the switch disengage?	Then...
No	<ol style="list-style-type: none"> Move the switch Down a few steps by turning the thumb wheel in the direction indicated on the arm. Replace the plate inside the gripper and listen for the switch to engage: <ul style="list-style-type: none"> If you do not hear the switch engage, then remove the plate and repeat steps a and b above. If you hear the switch engage, remove the plate and continue to step a below.
Yes	<ol style="list-style-type: none"> Move the switch Up by turning the thumb wheel one step in the direction indicated on the arm. Replace the plate and listen for the switch to engage: <ul style="list-style-type: none"> If you hear the switch engage, remove the plate and repeat steps a and b above. If you do not hear the switch engage, then you have successfully identified the zero point of the plate sensor switch. <p>Note: At the zero point, one step of the thumb wheel in the Down direction causes the switch to engage.</p>

5. After the zero point is established, carefully turn the thumb wheel in the Down direction the number of steps appropriate for your plate type, as indicated below:

Plate	Turn the thumb wheel in the Down direction...
Standard 384-well reaction plate	15 steps
Standard 96-well reaction plate	20 steps
TaqMan Low Density Array	15 steps

Note: If you lose count, begin again from [step 4](#) and identify the zero point for the switch.

Notes _____



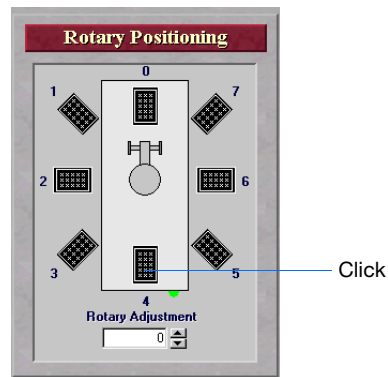

Testing the Adjustment

1. Place the plate in the input stack 1 of the Plate Handler.
2. Power on the 7900HT Fast System, the Plate Handler, and the computer.
3. Select **Start > Programs > Zymark Twister Plate Handler > Twister** to start the Zymark Twister Software.
4. Click **Manual Control** to open the Manual Control dialog box.
5. Click stack 4. The Plate Handler arm moves over the input stack.



6. Click **Find Plate**.
 - If the adjustment was successful, the Plate Handler arm will lower upon the plate until the plate sensor switch engages, confirming the presence of the plate.
 - If the Plate Handler arm emits a grinding sound, adjust the plate sensor switch:
 - a. In the Zymark Twister Software, click **Vertical Home** to raise the Plate Handler arm.
 - b. Turn the thumbscrew in the Down direction 10 steps.
 - c. Repeat [step 6](#) until the Plate Handler arm successfully detects the plate.

Notes _____

7. Click , then click .
 - If the adjustment was successful, the Plate Handler arm will grasp the plate and remove it from the plate stack.
 - If the Plate Handler arm stops before the gripper fingers are able to contact the plate and fails to grasp or pick up the plate, adjust the plate sensor switch:
 - a. Turn the thumbscrew in the Up direction 10 steps.
 - b. Grasp the plate with one hand and, from the Zymark Twister Software, click  to release the plate.
 - c. Replace the reaction plate into input stack 1 of the Plate Handler.
8. Repeat [steps 6 through 7](#) until the Plate Handler arm successfully retrieves the plate.
9. Grasp the plate with one hand and, from the Zymark Twister Software, click  to release the plate.
10. Exit the Zymark Twister Software:
 - a. Click .
 - b. Click **Quit Application** to close the software.

Confirm the Zymark Twister Software Is Closed

A defect in the Zymark Twister Software can cause portions of the program to persist in memory even after the software has been closed. Because the Zymark Twister Software conflicts with the SDS software, the residual elements of the Zymark Twister Software must be closed inside the Microsoft Windows® operating system Task Manager before continuing.

1. Press the **Ctrl + Alt + Del** keys in unison to open the Windows operating system Security dialog box.
2. Click **Task Manager** to open the Windows operating system Task Manager dialog box.
3. Click the **Applications** tab.
4. Confirm that the software has closed by looking for the Zymark Twister Software entry in the **Task** list.
 - If the software is completely closed, there is no entry for the Zymark Twister Software.
 - If the software is still running, click the Zymark Twister Software entry to select it, then click **End Task**.
5. Close the Task Manager dialog box.

Notes _____

Aligning the Plate Handler

When to Perform Align the Zymark Twister Microplate Handler if:

- You move the Applied Biosystems 7900HT Fast Real-Time PCR System
 - The Plate Handler is misaligned
- Symptoms that the Plate Handler is out of alignment include:
- Excessive downward movement of the Plate Handler arm (the arm grinds when grasping or releasing plates)
 - The Plate Handler arm collides with the plate stacks
 - The Plate Handler arm releases plates above the bottom of the plate stacks
 - Plates tip or tilt when placed into the instrument tray by the Plate Handler arm

Before You Begin

Time Required 30 minutes

Materials Required You need the materials listed below to perform this procedure.

Appropriate plate type for your current sample block; one of the following:

- Standard 384-well reaction plate
- Standard 96-well reaction plate
- TaqMan® Low Density Array

Note: The Automation Accessory should not be used for running Fast 96-well reaction plates.

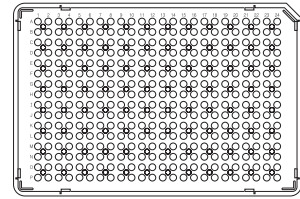

Pictured: Standard 384-well reaction plate

Notes _____

Workflow To align the plate handler:

1. Obtain the tools and materials required (shown above).
2. Prepare the 7900HT instrument (see [page 99](#)).
3. Align input stack 1 (see [page 100](#)).
4. Align the Plate Handler to the 7900HT instrument (see [page 102](#)).
5. Recheck input stack 1 (see [page 104](#)).
6. Define the bottom of the stack (see [page 105](#)).
7. Define the positions of the remaining stacks (see [page 107](#)).
8. Confirm the Zymark Twister Software is closed (see [page 108](#)).

Notes

Preparing the Instrument for the Alignment

1. Remove the covers for the fixed-position bar code reader and the underlying platform.

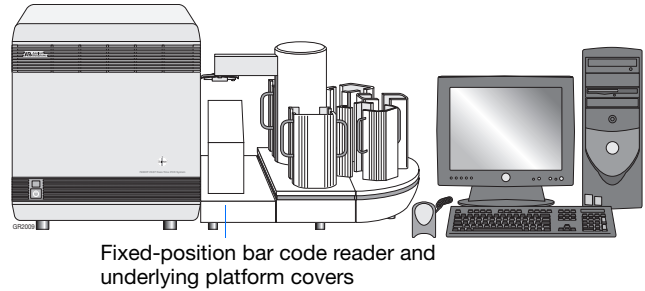

2. Loosen the three black thumbscrews on the platform connecting the 7900HT Fast System and the Plate Handler base.

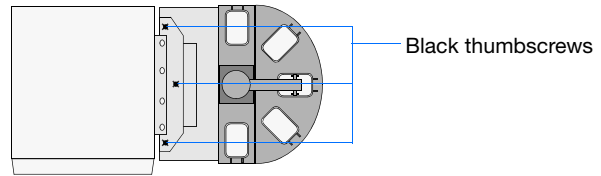

3. Power on the 7900HT Fast System, the Plate Handler, and the computer.
4. Move the instrument tray to the OUT position:
 - a. Double-click  on the desktop (or select **Start > All Programs > Applied Biosystems > SDS 2.3 > SDS Automation Controller 2.3**) to start the Automation Controller Software.

Note: If an error dialog box appears reading, **Machine calibration values are not valid. Please refer to documentation for calibration process**, click  .

- b. Click **Open/Close Door**. The 7900HT Fast System moves the instrument tray to the OUT position.
 - c. Select **File > Exit** to close the Automation Controller Software.
5. Select **Start > Programs > Zymark Twister Plate Handler > Twister** to start the Zymark Twister Software.
 6. Click **Manual Control** to open the Manual Control dialog box.

Notes _____

Aligning Input Stack 1 (Zyemark Position 4)

The alignment of input stack 1 (position 4 in the Zyemark Twister Software) is the first step in the alignment procedure. This alignment provides the basis for aligning all subsequent stacks on the Plate Handler.

1. Place an empty plate into input stack 1 (Zyemark position 4).
2. In the Zyemark Twister Software, click position 4. The Plate Handler arm moves over the input stack.

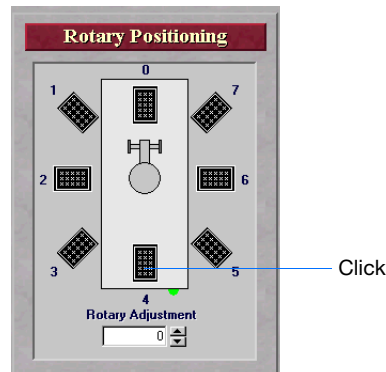

3. Using the Vertical Positioning commands, lower the Plate Handler arm until it is just above the stack. The Vertical Positioning commands provide five ways to move the Plate Handler arm:

- Move the slider for large increments.
- Click inside the slider bar to move the arm in 250-step increments.
- Click the lower arrow on the bar to move the arm in 50-step increments.
- Click the up or down arrows in the **Vertical Adjustment** text box to move the arm in 1-step increments.
- Click the **Vertical Adjustment** text box, enter a value, then press **Enter** to move the arm into a specific location.

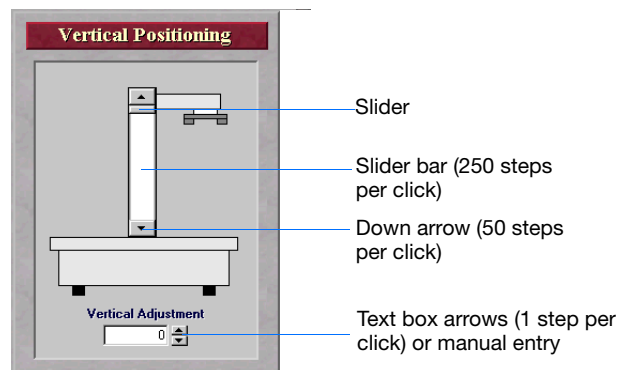

Notes _____

- Using the Rotary Adjustment arrows, adjust the rotational position of the gripper so that it is centered over the input stack and will not contact the sides when lowered.
 - To move the Plate Handler arm clockwise, click the up arrow.
 - To move the Plate Handler arm counter-clockwise, click the down arrow.

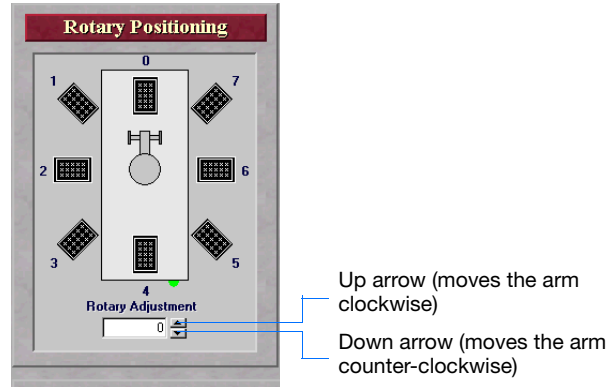



- Using the Vertical Positioning commands, carefully lower the Plate Handler arm into the stack. Change the Rotary Adjustment value as needed to center the gripper inside the stack.
- After the gripper is centered inside the stack, click **Find Plate** to lower the Plate Handler arm on the plate.
- Confirm the following:
 - The plate is in the middle of the gripper span
 - The plate sensor switch is contacting the plate
 - The gripper and plate do not contact the side of the stack
- Click **Close Gripper**. The gripper grips the plate between its fingers.
- Select **Vertical Home**. The Plate Handler raises the arm to its highest position. If the plate contacts the sides of the stack, readjust the rotary position of the Plate Handler arm until the plate moves freely in the stack.

Note: Contact between the plate and the stack or all stacks may be unavoidable. However, try to minimize the contact as much as possible.



- Using the Vertical Positioning commands, raise and lower the Plate Handler arm several times to check the alignment.

Notes

11. Lower the Plate Handler arm to the bottom of the plate stack, click , then click . The software records the rotary position for the Zymark position 4 (input stack 1).
12. Click . The gripper releases the plate.

Aligning the Plate Handler to the Instrument Tray

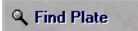
The next step is to align the Plate Handler arm to the instrument tray (Zymark position 2). This alignment will ensure a smooth exchange between the Plate Handler arm and the instrument tray during instrument operation.

1. If not already present, place an empty plate into input stack 1 (Zymark position 4) and pick it up with the Plate Handler arm:
 - a. In the Zymark Twister Software, click position 4.
 - b. Click .
 - c. Click .
2. Click position 2. The Plate Handler arm moves over the instrument tray.
3. Using the Vertical Positioning commands, lower the Plate Handler arm until it is approximately 1 cm above the instrument tray.

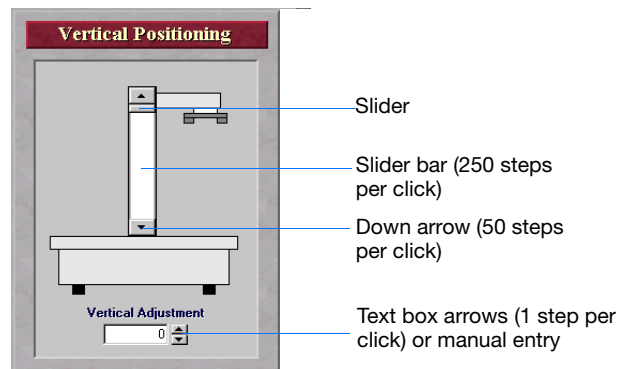
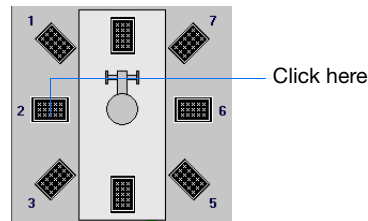

Notes _____

4. Using the Rotary Adjustment arrows, center the gripper and plate along the Y-axis of the instrument tray.

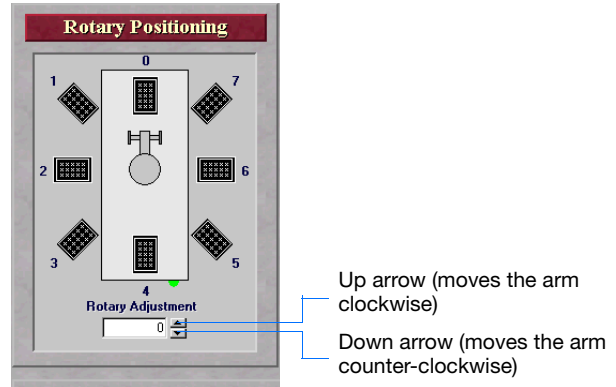

5. Center the gripper and plate along the X-axis of the instrument tray by sliding the Plate Handler and base towards or away from the 7900HT Fast System.

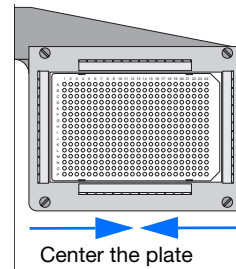
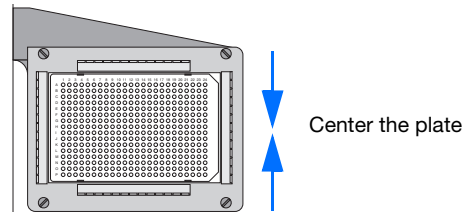

6. Again using the Rotary Adjustment arrows, center the gripper and plate along the Y-axis of the instrument tray, as shown in step 4 above.



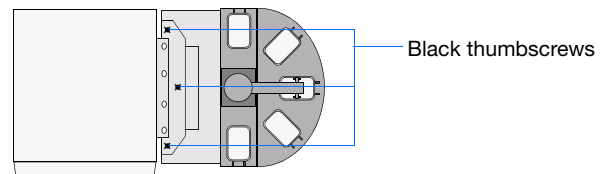

7. Using the Vertical Positioning commands, carefully lower the Plate Handler arm onto the instrument tray and confirm that the plate rests squarely inside it.

8. Tighten the three black thumbscrews on the platform connecting the 7900HT Fast System and the Plate Handler.



9. Release the plate from the Plate Handler arm:
 - a. Click Open Gripper .
 - b. Click Vertical Home .

Notes _____

10. Click . The Plate Handler arm lowers onto the plate.
11. Save the rotary and vertical offset information:
 - a. Click , then click . The software records the rotary position for the plate drawer (Zymark position 2).
 - b. Click , then click . The software records the vertical position for the plate drawer.

Rechecking the Input Stack 1

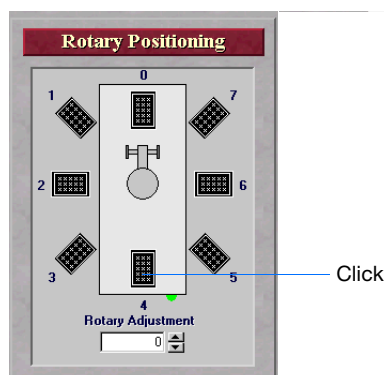

Now that the positions of the Plate Handler and instrument are fixed, the Plate Handler stacks can be aligned and the positional values recorded.

1. If not already present, place an empty plate into input stack 1 (Zymark position 4).
2. In the Zymark Twister Software, click position 4. The Plate Handler arm moves over the input stack.



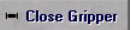

3. Using the Vertical Positioning commands, lower the Plate Handler arm until it is 1 cm above the stack and verify that it is centered on the stack. If necessary, center the stack using the Rotary Adjustment arrows.
4. Carefully lower the Plate Handler arm into the stack. Center the gripper as it moves down the stack by adjusting the Rotary Adjustment arrows if needed.
5. After the Plate Handler arm is centered inside the stack, click . The Plate Handler arm lowers upon the plate.

Notes _____

6. Confirm the following:
 - The plate is in the middle of the gripper span.
 - The plate sensor switch is contacting the plate.
 - The gripper does not contact the side of the stack.
7. Click  .
8. Click  . The Plate Handler raises the arm to its highest position. If the plate contacts the sides of the stack, re-adjust the rotary position of the Plate Handler arm until the plate moves freely inside the stack.

Note: Contact between the plate and the stack or all stacks may be unavoidable. However, try to minimize the contact as much as possible.









9. Click  , then click  . The software re-records the rotary position for input stack 1 (Zymark position 4).
10. While holding the plate, click  and remove the plate.

Defining the Bottom of the Stack

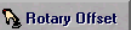
The Automation Controller Software requires a bottom position value for all stacks. This value is used to prevent the Plate Handler arm from colliding or grinding as it moves to the bottom of each stack.

1. Remove all plates from the instrument and the Plate Handler arm.
2. Place an empty plate into the output stack (Zymark position 0).
3. In the Zymark Twister Software, click position **0**. The Plate Handler arm moves over the output stack.
4. Using the Vertical Positioning commands, lower the Plate Handler arm until it is just above the stack.
5. Using the Rotary Adjustment arrows, adjust the rotational position of the gripper so that it is centered over the input stack and will not contact the sides when lowered.
6. Using the Vertical Positioning commands, carefully lower the Plate Handler arm into the stack. Change the Rotary Adjustment value as needed to center the gripper inside the stack.
7. After the gripper is centered inside the stack, click  . The Plate Handler arm lowers upon the plate.

Notes _____

8. Confirm the following:
 - The plate is in the middle of the gripper span
 - The plate sensor switch is contacting the plate
 - The gripper does not contact the side of the stack
 9. Click . The gripper grips the plate between its fingers.
 10. Select . The Plate Handler raises the arm to its highest position. If the plate contacts the sides of the stack, readjust the rotary position of the Plate Handler arm until the plate moves freely in the stack.
-
- Note:** Contact between the plate and the stack may be unavoidable. However, try to minimize the contact as much as possible.
-
11. Using the Vertical Positioning commands, raise and lower Plate Handler arm several times to check the alignment.
 12. Lower the Plate Handler arm, click , then click . The software records the rotary position for position 0 (the output stack).
 13. Click the .
 14. While holding the plate, click  and remove the plate.
 15. In the Vertical Adjustment field, enter **-3200**, then press **Enter**. The Plate Handler lowers the arm to a position near the base of the output stack.
 16. Carefully lower the Plate Handler arm until it is approximately 1–2 mm from the bottom of the stack.
 17. Click , click , then record the number in the Vertical Adjustment field. The software records the vertical position for position 0 (the output stack).
 18. Click . The Plate Handler raises the Plate Handler arm to its highest position.
 19. In the Vertical Adjustment field, enter the Vertical Offset value determined in [step 17](#), and press **Enter**. The Plate Handler lowers the Plate Handler arm to a Vertical Offset position.
 20. If necessary, readjust the **Vertical Offset** value and repeat [steps 18 through 19](#) until satisfied with the setting.

Notes _____



Defining the Positions of the Remaining Stacks

1. Place an empty plate into input stack 2 (Zymark position 5).
2. In the Zymark Twister Software, click position **5**. The Plate Handler arm moves over the input stack.
3. Using the Vertical Positioning commands, lower the Plate Handler arm until it is approximately 1 cm above the stack, then center it using the Rotary Adjustment arrows.
4. Carefully lower the Plate Handler arm into the stack. Center the gripper as it moves down the stack by adjusting the Rotary Adjustment arrows as needed.
5. After the Plate Handler arm is centered inside the stack, click . The Plate Handler arm lowers upon the plate.
6. Confirm the following:
 - The plate is in the middle of the gripper span.
 - The plate sensor switch is contacting the plate.
 - The gripper does not contact the side of the stack.

7. Click .

8. Click . The Plate Handler arm raises to its highest position. If the plate contacts the sides of the stack, readjust the rotary position of the Plate Handler arm until the plate moves freely in the stack.

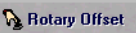
Note: Contact between the plate and the stack may be unavoidable. However, try to minimize the contact as much as possible.

9. Using the **Vertical Positioning** commands, raise and lower Plate Handler arm several times to check the alignment.
10. Click , and click . The software records the rotary position for the Zymark position 5 (input stack 2).

Notes _____

11. Repeat [steps 1 through 10](#) for input stacks **3** and **4** to define Rotary Offset values for the remaining positions **6** and **7**.

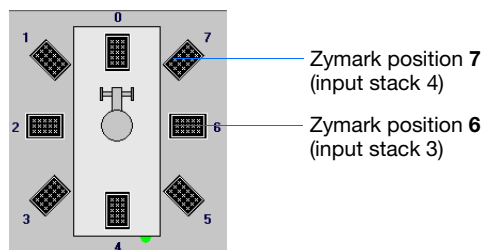

12. Exit the Zymark Twister Software:
- Click .
 - Click **Quit Application** to close the software.

13. Replace the covers for the fixed-position bar code reader and the underlying platform (removed in [step 1 on page 99](#)).

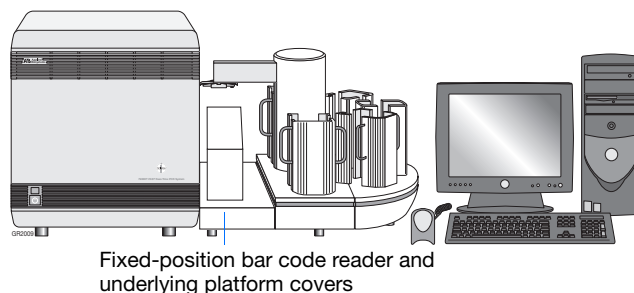

Confirm the Zymark Twister Software Is Closed

A defect in the Zymark Twister Software can cause portions of the program to persist in memory even after the software has been closed. Because the Zymark Twister Software conflicts with the SDS software, the residual elements of the Zymark Twister Software must be closed inside the Windows operating system Task Manager before continuing.

- Press the **Ctrl + Alt + Del** keys in unison to open the Windows operating system Security dialog box.
- Click **Task Manager** to open the Windows operating system Task Manager dialog box.
- Click the **Applications** tab.

Notes _____

4. Confirm that the software has closed by looking for the Zymark Twister Software entry in the **Task** list.
 - If the software is completely closed, there is no entry for the Zymark Twister Software.
 - If the software is still running, click the Zymark Twister Software entry to select it, then click **End Task**.
5. Close the Task Manager dialog box.

Notes _____

Aligning the Fixed-Position Bar Code Reader

Two Bar Code Readers

Two bar code readers are available for the 7900HT Fast System:

- CLV Fixed-Position Bar Code Reader
- LD Fixed-Position Bar Code Reader

This section provides procedures for aligning both bar code readers.

When to Perform

The fixed-position bar code reader must be set so that it automatically scans the plate's bar code as the plate is placed into the instrument tray by the Plate Handler.

Align the fixed-position bar code reader:

- Whenever the Automation Accessory platform is moved from its calibrated position (for example, during Service visits)

Before You Begin

Time Required 20 minutes

Materials Required

You need the materials listed below to perform this procedure.

Appropriate plate type for your current sample block; one of the following:

- Standard 384-well reaction plate
- Standard 96-well reaction plate
- TaqMan® Low Density Array

Note: The Automation Accessory should not be used for running Fast 96-well reaction plates.

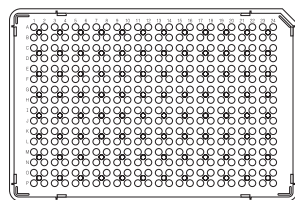

Pictured: Standard 384-well reaction plate

Workflow

To align the fixed-position bar code reader:

1. Obtain the tools and materials required (shown above).
2. Prepare the 7900HT instrument (see [page 111](#)).
3. Align the fixed-position bar code reader. Be sure to follow the right alignment procedure for your bar code reader:
 - “[Aligning the CLV Fixed-Position Bar Code Reader](#)” on [page 112](#), or
 - “[Aligning the LD Fixed-Position Bar Code Reader](#)” on [page 114](#)

Notes _____

Preparing the Instrument for the Alignment

1. Remove the cover for the fixed-position bar code reader.

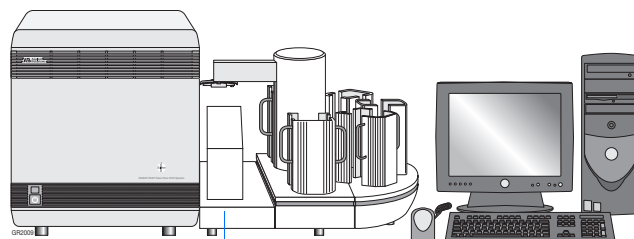

Fixed-position bar code reader cover

2. Power on the 7900HT Fast System and the computer.
3. Move the instrument tray to the OUT position:
 - a. Double-click  on the desktop (or select **Start > All Programs > Applied Biosystems > SDS 2.3 > SDS Automation Controller 2.3**) to start the Automation Controller Software.

Note: If an error dialog box appears reading, **Machine calibration values are not valid. Please refer to documentation for calibration process**, click .

- b. Click **Open/Close Door**. The 7900HT Fast System moves the instrument tray to the OUT position.
 - c. Select **File > Exit** to close the Automation Controller Software.
4. Continue with:
 - “Aligning the CLV Fixed-Position Bar Code Reader” on page 112, *or*
 - “Aligning the LD Fixed-Position Bar Code Reader” on page 114

Notes _____

Aligning the CLV Fixed-Position Bar Code Reader

Note: This procedure is for the CLV Fixed-Position Bar Code Reader. If you are aligning the LD Fixed-Position Bar Code Reader, see [page 114](#).

IMPORTANT! The instrument tray must be in the OUT position to align the bar code reader.

1. Place a plate with bar code onto the instrument tray.

IMPORTANT! Orient the plate so that well **A1** aligns to the **A1** position of the instrument tray and that the bar code faces the fixed-position bar code reader.

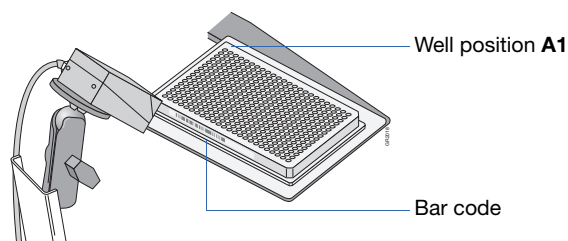

2. Select **Start > All Programs > CLV Setup v 4.1** to start the CLV software.
3. In the CLV Setup window:
 - a. Click the **Device** drop-down list and select **CLV42x**.
 - b. Click  (**Terminal**) to open the Terminal dialog box.

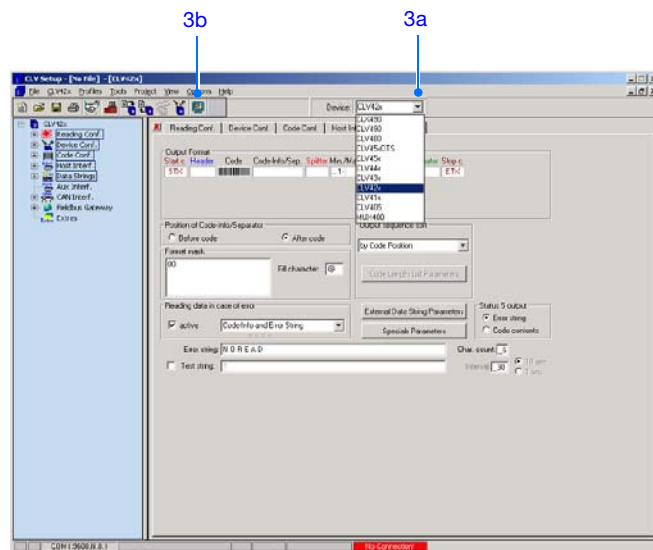

Notes _____

- In the Terminal dialog box, select **Percent Evaluation**.

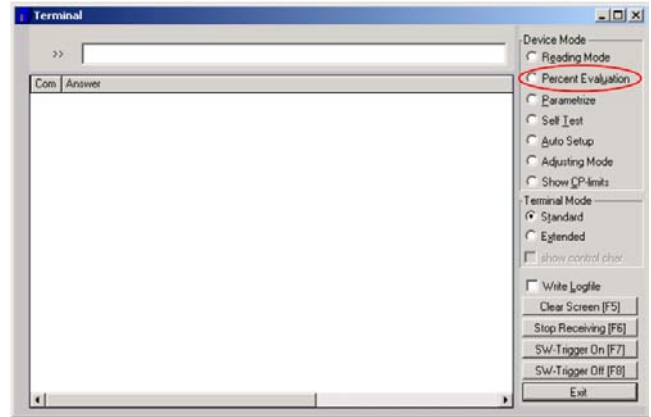

- Loosen the black positional adjustment knob on the fixed-position bar code reader, and position the scan head of the reader as far as possible from the plate while maintaining the orientation towards the bar code on the plate.

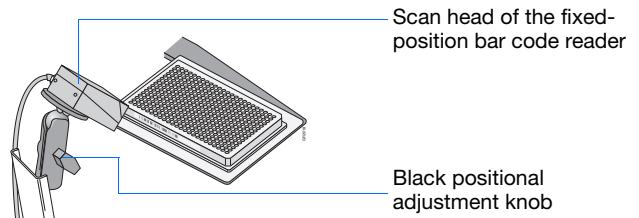

- While watching the Terminal dialog box, slowly adjust the orientation of the fixed-position bar code reader until the Terminal dialog box reads more than 20%.

Note: The Percent Evaluation depends on how many lines hit the bar code label.

Note: It may be helpful to briefly place a sheet of white paper in front of the plate bar code to view the area scanned by the laser.

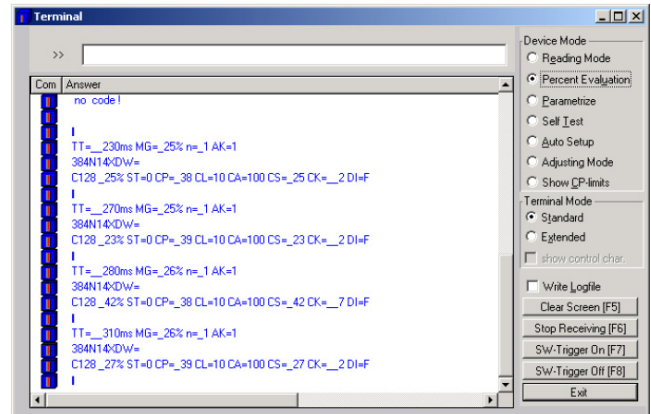

- When satisfied with the alignment, tighten the black positional adjustment knob on the fixed-position bar code reader.
- Click **Exit** to close the Terminal dialog box, then close the CLV software.
- Replace the cover for the fixed-position bar code reader (removed in [step 1 on page 111](#)).

Notes

Aligning the LD Fixed-Position Bar Code Reader





Note: This procedure is for the LD Fixed-Position Bar Code Reader. If you are aligning the CLV Fixed-Position Bar Code Reader, see [page 112](#).

IMPORTANT! The instrument tray must be in the OUT position to align the bar code reader.

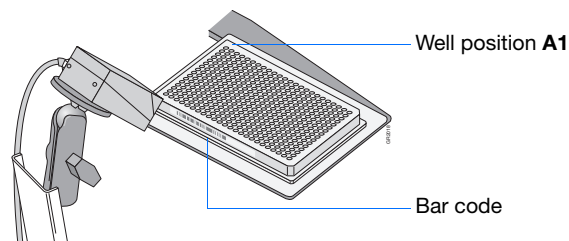
1. Place a plate with bar code onto the instrument tray.

IMPORTANT! Orient the plate so that well **A1** aligns to the **A1** position of the instrument tray and that the bar code faces the fixed-position bar code reader.



2. Select **Start > All Programs > PSC Laser Data > LDHOST** to start the LDHOST software.
3. Establish communication with the fixed-position bar code reader:
 - a. Click  (**Edit**) to open the Edit Configuration dialog box.
 - b. Click  (**Terminal**) to open the Terminal dialog box.
 - c. In the Device Control dialog box, click  (**Connect to Device**). The Terminal dialog box displays the fixed-position bar code reader response.
 - d. Click  to close the information message.

The LD Host program communicates with the bar code reader and updates the Edit Configuration dialog box with the current configuration settings.

Notes _____

4. Configure the software for the alignment:

- a. In the bottom of the Edit Configuration dialog box, locate and select the **Op. Modes** tab.

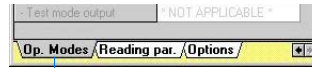

Op. Modes tab

Note: You may need to use the arrows located in the bottom of the dialog box to locate the Op. Modes tab.

- b. In the Operating modes selection pane of the Edit Configuration dialog box, click the **Mode** drop-down list and select **Test**.



Mode drop-down list

- c. In the Device Control dialog box, click **RAM** to toggle to **EEPROM** mode, then click **Send**.



RAM button

- d. In the Confirm dialog box, click **YES** to save to EEPROM.

The fixed-position bar code reader begins a continuous repeating scan of the bar code. The software updates the Terminal dialog box every 0.5 sec indicating the percentage of accurate reads completed during the 0.5 sec interval.

- 5. Loosen the black positional adjustment knob on the fixed-position bar code reader, and position the scan head of the reader as far as possible from the plate while maintaining the orientation towards the bar code on the plate.

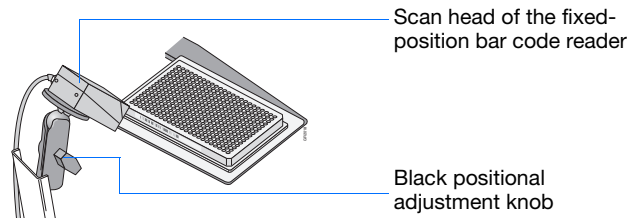

Scan head of the fixed-position bar code reader

Black positional adjustment knob

Notes

6. While watching the Terminal dialog box, slowly adjust the orientation of the fixed-position bar code reader until the percent successful reading displays the highest number possible.

Note: It may be helpful to briefly place a sheet of white paper in front of the plate bar code to view the area scanned by the laser.



7. When satisfied with the alignment, tighten the black positional adjustment knob on the fixed-position bar code reader.
8. Restore the fixed-position bar code reader to normal operation:
- In the Operating modes selection pane of the Edit Configuration dialog box, click the **Mode** drop-down list and select **Serial on Line**.
 - In the Device Control dialog box, confirm that **EEPROM** is still selected, then click **Send**.
 - In the New Decision dialog box, click **YES** to save to EEPROM.

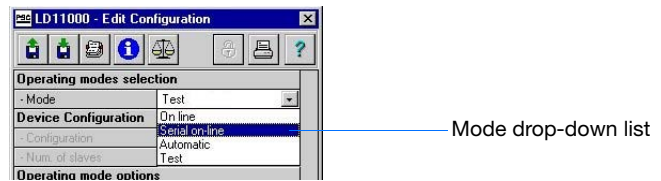

The bar code reader stops scanning the plate bar code and resumes normal operation.

9. Click  (**Exit**) to close the LDHOST software.
10. Replace the cover for the fixed-position bar code reader (removed in [step 1 on page 111](#)).

Notes _____

Troubleshooting the Automation Accessory

Troubleshooting Table

Table 4-2 Troubleshooting the Automation Accessory

Observation	Possible Cause	Recommended Action
Plate Handler emits grinding noise when picking up or putting down plates	Vertical offset too low	Re-align the Plate Handler as explained in “Aligning the Plate Handler” on page 97.
	Plate detector switch set too high	
Plate Handler arm contacts racks when retrieving or stacking plates	Plate Handler rotary offset is incorrect or vertical offset is too low	
The Plate Handler arm releases plates awkwardly into the plate racks		
Reaction plates tip or tilt when placed into the instrument tray by the Plate Handler arm		
Plate Handler fails to sense or grasp plates	Plate sensor switch not adjusted properly	Adjust the plate sensor switch as explained in “Adjusting the Plate Sensor Switch” on page 92.
	Gripper pads on the fingers of the Plate Handler arm are worn or dirty	Change the gripper pads as explained in “Cleaning and Replacing Gripper Finger Pads” on page 90.
Plates stick to the gripper fingers of the Plate Handler arm	Gripper pads are worn or dirty	Change the gripper pads as explained in “Cleaning and Replacing Gripper Finger Pads” on page 90.
Plate Handler does not restack plates in original locations	Restack when finished option not selected	Configure the Automation Controller Software to restack the plates. See the <i>Sequence Detection Systems Software version 2.3 Online Help (SDS Online Help)</i> .
Fixed-position bar code reader not reading plate bar codes	Bar code reader is misaligned	Re-align the fixed-position bar code reader as explained in “Aligning the Fixed-Position Bar Code Reader” on page 110.
	Bar code reader is broken	

Notes _____



Chapter 4 Maintaining the Automation Accessory
Troubleshooting the Automation Accessory

Notes _____

5

Troubleshooting Chemistry and Assay Runs

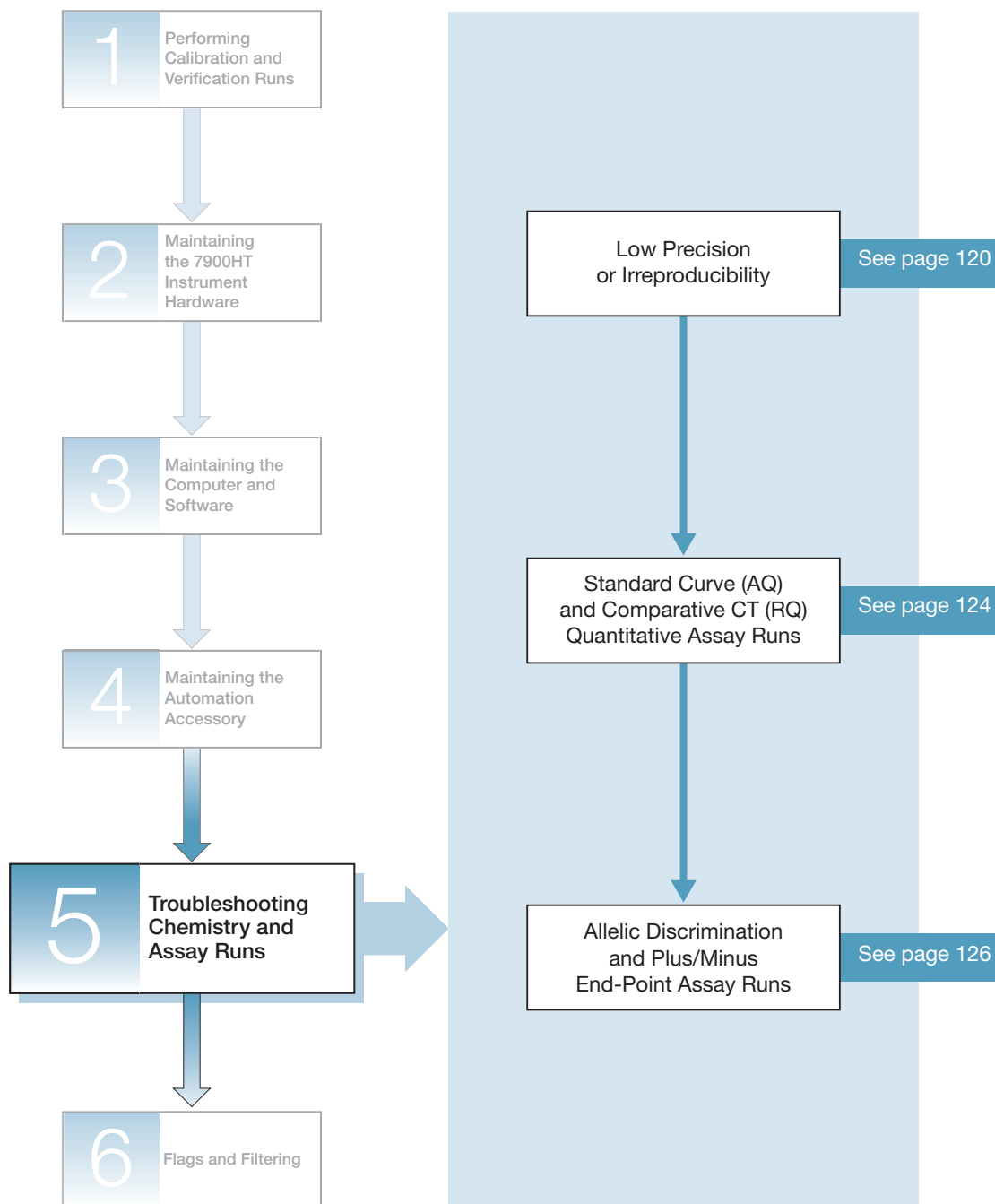

Notes

Low Precision or Irreproducibility

Overview There are various reasons why an assay run with the Applied Biosystems 7900HT Fast Real-Time PCR System can have less than optimal precision. Factors that can affect precision are described in detail below.

Improper Threshold Setting	120
Imprecise Pipetting	121
Non-Optimized Chemistry	121
Incomplete Mixing	121
Air Bubbles	121
Splashing PCR Reagents	121
Drops	122
Writing on the Reaction Plates	122
Fluorescent Contamination on the Plates	122
Errors	122
Contaminated Sample Block	122
Improper or Damaged Plastics	123
Low Copy Templates	123
Use of Non-Applied Biosystems PCR Reagents	123

Improper Threshold Setting The key to high-precision quantitative PCR is accurate detection of the exponential (geometric) phase. The Applied Biosystems 7900HT Fast Real-Time PCR System typically delivers sufficient sensitivity so that at least three cycles of the geometric phase are visible, assuming reasonably optimized PCR conditions. The SDS software calculates a fixed signal intensity, called a threshold, that each signal generated from PCR amplification must reach before it is recognized by the software as actual amplification. The calculated threshold is an approximation, and should be examined and modified as needed.

Modifying the Threshold

In a real-time document of the SDS software, the threshold can be modified via the Amplification Plot view following analysis of the run data. See the *Sequence Detection Systems Software version 2.3 Online Help (SDS Online Help)* for more information.

Notes _____

Imprecise Pipetting The calculated quantities of target nucleic acid are directly affected by how precisely the template or reagent volumes are added to the reaction mixes.

Using Master Reaction Mixes

Applied Biosystems highly recommends using a master reaction mixture. Mix all common components (including the same template) to a set of reactions together, then dispense the mix to the replicate wells of the plate. When making each master reaction mix, add 5–10% additional volume to compensate for pipetting losses.

Using Pipettors

Pipetting precision is also improved by:

- Calibrating and servicing the pipettors regularly
- Pipetting larger volumes
- Reducing the number of pipetting steps whenever possible
- Increasing the consistency of the pipetting method

Consult the manufacturer about the correct method of dispensing liquid volumes accurately from the pipettor. For example, some pipettors are designed to deliver the designated volume at the first plunger stop, so ‘blowing out’ the residue may cause error. Also, before using a new pipettor tip to serially dispense a master reaction mix, wet the tip once by drawing up some of the master reaction mix and dispensing it back into the mix again.

Non-Optimized Chemistry Chemistries that have not been optimized may be susceptible to inconsistencies. To maximize precision and reaction efficiency, optimize the primer and probe concentrations of each individual assay used. Refer to the *TaqMan® Universal PCR Master Mix Protocol* (PN 4304449) for specific information about optimizing probe and primer concentrations for TaqMan-related chemistries.

Note: TaqMan® Gene Expression Assays, TaqMan® SNP Genotyping Assays, and Custom TaqMan® SNP Genotyping Assays do not require optimization.

Incomplete Mixing For maximum precision, the PCR master reaction mix must be uniform. After adding all reaction components to the mix, vortex the mix for 4–5 seconds before aliquoting it to the wells of the plate. Also vortex any dilutions performed during the assay.

Air Bubbles Air bubbles in the wells can refract and distort the fluorescent signals. Ideally, the reagents would be applied to the wells using a pipetting technique that does not form air bubbles. However, if a plate does contain air bubbles, they can usually be removed by swinging, tapping, or briefly centrifuging the reaction plate.

Splashing PCR Reagents If PCR reagents splash the undersides of the optical adhesive covers, the heat from the lid may bake the liquid to the cover and may distort the signal. If splashing occurs, briefly centrifuge the reaction plate to remove all traces of liquid from the caps.

Notes _____

Drops Drops of reagents that cling to the sides of the wells may not contact the thermal cycler sample block and consequently may not amplify. If the drop slides into the mix during PCR, then the amplified products will become diluted and the result will be less than replicate wells that did not have drops. Therefore, carefully monitor the reaction plate as it is being transferred into the thermal cycler or 7900HT Fast System. If you observe any drops, take steps to remove them, such as centrifugation.

Writing on the Reaction Plates Do not write on any surface of the optical plates or the optical adhesive covers. The fluorescent properties of the ink can potentially affect the fluorescence emission from the plate and alter the results. Instead, note the contents of each well on a sheet of paper, or on a printout of the sample setup.

Fluorescent Contamination on the Plates Many compounds found in laboratories are fluorescent. If they come into contact with certain optical surfaces, such as the optical adhesive covers, the fluorescent results may be affected. For example, it has been noted that the powder used to lubricate the insides of plastic gloves often contains fluorescent compounds. Use only powder-free gloves and do not needlessly touch the reaction plates or optical adhesive seals.

Errors Human errors from time to time are inevitable, such as pipetting into the wrong well, or making a dilution mistake.

Human error can be reduced in the following ways:

- Perform the assay in a systematic fashion. For example, the pattern of sample positions should be simple (avoid putting gaps in the rows).
- When pipetting the master reaction mix, look directly down into the reaction plate so that you can verify the transfer of the solution.
- If adding a small-volume reagent, such as template, place the drop of liquid on the side of the well. Briefly tap or centrifuge the plate afterwards to bring the droplet down into the well.
- After all pipetting is complete, visually inspect all the wells to confirm the presence of the reagent drops. Tapping or centrifuging the reaction plate will cause all the drops to slide down into the wells simultaneously.
- When making serial dilutions, be sure to change the pipet tip after each dilution step.
- Visually inspect the liquid volumes being pipetted to verify that the volume is approximately correct. A common mistake is using the wrong pipettor volume setting (such as setting 20 μL instead of 2.0 μL).
- Visually inspect the volumes of the completed reactions, looking for any wells that have volumes that do not match those of the other wells.

Contaminated Sample Block Any material contaminating the sample block can affect the results. For example, mineral oil reduces thermal transfer. Residue from writing on reaction plates darkens the wells, absorbing light.

Notes _____

The sample blocks should be periodically inspected for cleanliness. Sample block contamination can be visualized by running a background plate and inspecting the resulting background signal for aberrant peaks above 4000 FSU (see [page 15](#)). See [page 65](#) for instructions on decontaminating the sample block.

Improper or Damaged Plastics

Applied Biosystems recommends that you use Applied Biosystems optical plates, optical adhesive covers, and optical flat caps with the 7900HT Fast System. The plastics that comprise the optical parts undergo special testing for the absence of fluorescent impurities. Optical plates are frosted to improve the degree and precision of light reflection. Bent, creased, or damaged plastics may adversely affect the transmission of fluorescent signal or prevent proper sealing of a well resulting in evaporation, change in sample volume, and altered PCR chemistry. Make sure to use the correct plastics and visually inspect each reaction plate before use.

Note: See [Appendix C, “Parts and Consumables,”](#) on [page 157](#) for a list of compatible consumables and reagents.

Low Copy Templates

When amplifying samples that contain very low quantities of nucleic acid (generally less than 100 molecules), expect lowered precision due to the Poisson distribution and biochemical effects related to binding probabilities. Low copy templates are also more susceptible to losses due to non-specific adhesion to plastic wells, pipettor tips, etc. The addition of carrier to the sample, such as yeast tRNA or glycogen, can help prevent these losses, increasing the precision and sensitivity of the assay.

Use of Non-Applied Biosystems PCR Reagents

The Applied Biosystems buffer contains an internal passive reference molecule (ROX™ dye), which acts as a normalization factor for fluorescent emissions detected in the samples.

IMPORTANT! Non-Applied Biosystems PCR buffers may not contain the ROX passive reference dye. If running non-Applied Biosystems chemistry, be sure to set the passive reference for your experiment as explained below.

Setting the Passive Reference

1. Open the appropriate plate document in the SDS software.
2. Select the **Setup** tab.
3. From the Passive Reference drop-down list, select the appropriate passive reference dye.

Notes _____

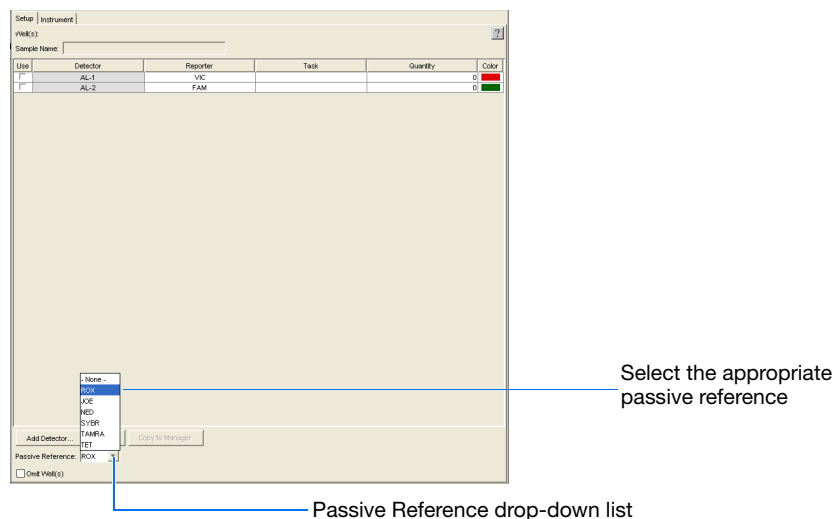

Standard Curve (AQ) and Comparative C_T (RQ) Quantitative Assay Runs

Troubleshooting Analyzed Data

When faced with irregular data, you can use the SDS software to diagnose some chemistry- and instrument-related problems. The following table contains a summary of checks for verifying the integrity of your run data and to help you begin troubleshooting potential problems.

Raw Data Plot

The Raw Data Plot displays the raw reporter fluorescence signal (not normalized) for the selected wells during each cycle of the real-time PCR.

What to look for:

- **Signal tightness and uniformity** – Do the raw spectra signals from replicate groups and controls exhibit similar spectral ‘profiles’? If not, the plate or sample block could be contaminated.
- **Characteristic signal shape** – Do the samples peak at the expected wavelengths? For example, samples containing only FAM™ dye-labeled TaqMan® probes should not produce raw fluorescence in the wavelength of a VIC® dye component. A signal present in wells that do not contain the dye could indicate that the sample, master mix, or well contains contaminants.
- **Characteristic signal growth** – As you drag the bar through the PCR cycles, do you observe growth as expected? Absent growth curves may indicate a pipetting error (for example, well lacks template) or no amplification.
- **Signal Plateaus** – Do any of the signals plateau? Signal plateaus or saturation can be an indication that a well contains too much template or fluorescent signal.

Notes _____

Multicomponent Plot

The Multicomponent Plot displays a plot of normalized multicomponent data from a single well of a real-time run. The plot displays the component dye signals that contribute to the composite signal for the well.

What to look for:

- **Correct dyes displayed** – Does the plot display all dyes as expected? The presence of an unexpected dye may be the result of an error in detector setup, such as assigning the wrong reporter or quencher dye.
- **ROX dye fluorescence level** – Does the ROX dye signal fluoresce below the reporter dyes? If not, the lack of reporter fluorescence may be caused by an absence of probe in the well (a pipetting error).
- **Background fluorescence** – Do all dyes fluoresce above the background? The Background signal is a measure of ambient fluorescence. If a dye fails to fluoresce above the background, it is a strong indication that the well is missing probes labeled with the dye (well does not contain probe, PCR master mix, or both).
- **MSE Level** – The MSE (mean squared error) is a mathematical representation of how accurately the multicomponented data fits the raw data. The higher the MSE value, the greater the deviation between the multicomponented data and the raw data.

Amplification Plot

The Amplification plot displays data from real-time runs after signal normalization and Multicomponent analysis. It contains the tools for setting the baseline and threshold cycle (C_T) values for the run.

What to look for:

- **Correct baseline and threshold settings** – Are the baseline and threshold values set correctly?
Identify the components of the amplification curve and set the baseline so that the amplification curve growth begins at a cycle number that is greater than the highest baseline number.
Identify the components of the amplification curve and set the threshold so that it is:
 - Above the background
 - Below the plateaued and linear regions
 - Within in the geometric phase of the amplification curve

IMPORTANT! After analysis, you must verify that the baseline and threshold were called correctly for each well by clicking on the well in the Plate Grid and viewing the resulting plots. For more information about manually adjusting the baseline and threshold settings, refer to the *SDS Online Help*.

- **Irregular amplification** – Do all samples appear to have amplified normally? The three phases of the amplification curve should be clearly visible in each signal.

Notes _____

- **Outlying amplification** – When the run data is viewed in the C_T vs. Well Position plot, do replicate wells amplify comparably? Wells producing C_T values that differ significantly from the average for the associated replicate wells may be considered outliers.

If a plate produces non-uniformity between replicates, some samples on the plate could have evaporated. Check the seal of the optical adhesive cover for leaks.

Allelic Discrimination and Plus/Minus End-Point Assay Runs

Troubleshooting Analyzed Data

When faced with irregular data, you can use the SDS software to diagnose some chemistry- and instrument-related problems. The following table contains a summary of checks for verifying the integrity of your run data and to help you begin troubleshooting potential problems.

Raw Data

The Raw Data Plot displays the raw reporter fluorescence signal (not normalized) for the selected wells during each cycle of the PCR.

What to look for...

- **Signal tightness and uniformity** – Do the raw spectra signals from replicate groups and controls exhibit similar spectral ‘profiles’? If not, the plate or sample block could be contaminated.
- **Characteristic signal shape** – Do the samples peak at the expected wavelengths? For example, samples containing only FAM dye-labeled TaqMan probes should not produce raw fluorescence in the peak wavelength of the VIC dye component. A signal present in wells that do not contain the dye could indicate that the sample, master mix, or well contains contaminants.
- **Signal Plateaus** – Do any of the signals plateau? Signal plateaus or saturation can be an indication that a well contains too much template or fluorescent signal.

Notes _____

6

Flags and Filtering

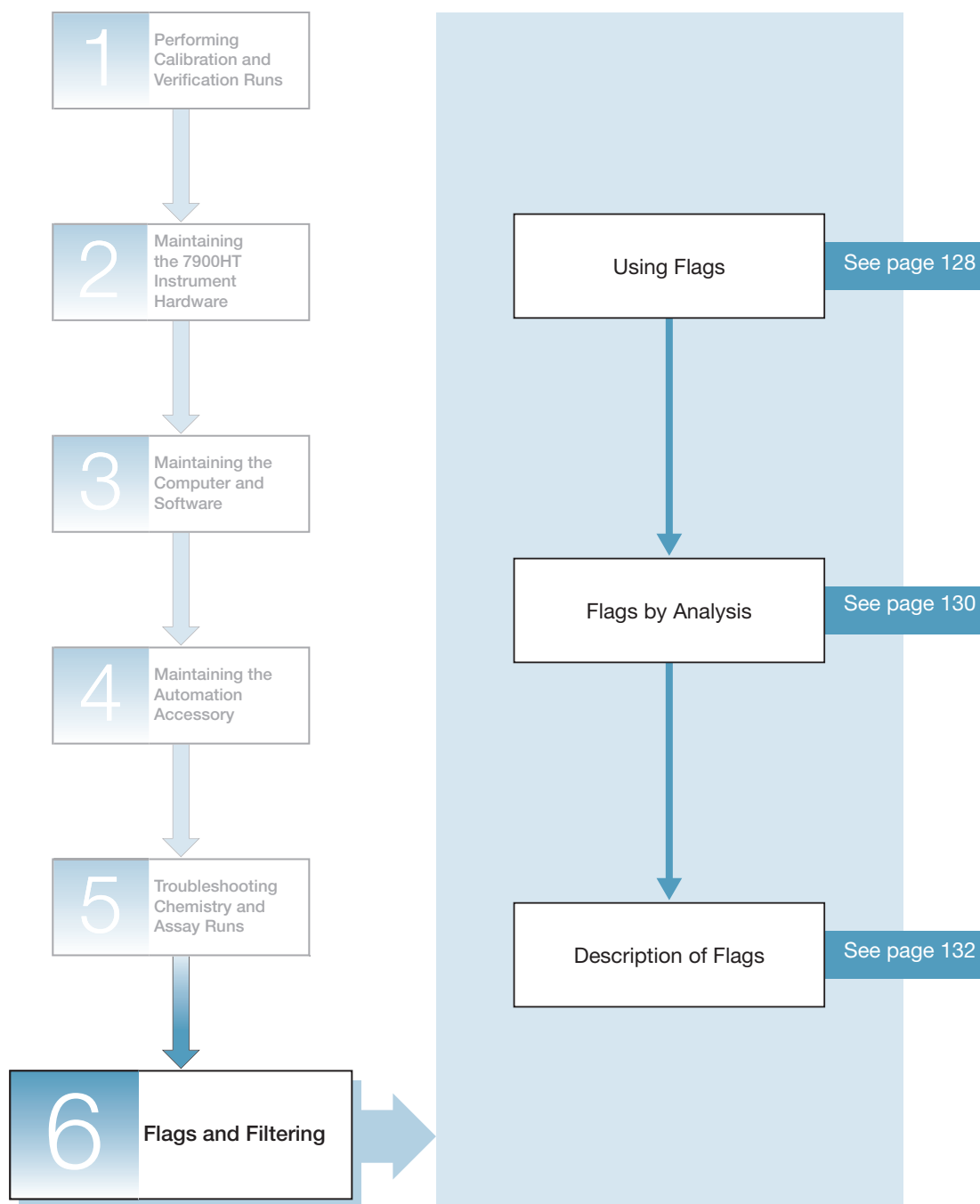

Notes

Using Flags

Flags and Troubleshooting

Version 2.3 of the Sequence Detection Systems (SDS) Software features a system of flags that provide the basis for algorithmically identifying and eliminating problematic data from plate document and RQ study analysis. The flags are application-specific metrics, where each evaluates the data for a specific quality that is consistent with a problem common to a supported analysis. The system is designed to allow you to automatically exclude questionable data, alert you to potential problems, and provide you with a starting point for investigation.

About Flags

Each flag is the result of a unique algorithmic test that evaluates a specific property of the plate document data. The software performs the tests in a specific sequence and completes the analysis of the plate document even if one or more wells is flagged. Every flag yields a pass/fail result that indicates the success of the associated test. If a flag is enabled, the software indicates the status of the test in the appropriate column of the Results Table, as follows:





- A ✓ for a well that is flagged (Fail)
- Blank for a well that is not flagged (Pass)

In the SDS Software, you can automatically flag results data to meet specified criteria. Flags are assay specific and are user configured or automatically assigned.

- Automatically assigned flags are not user configurable. These flags are displayed in the Results table and the QC Summary tab.
- User configured flags are set/defined by the user. These flags are also displayed in the Results table and QC Summary tab.

Flag Symbols

Following an analysis, the software summarizes the results of the flag metrics for each sample by displaying one of four symbols. These symbols appear in the Flag column of the Results Table and in the Plate Grid.

Symbol	Definition
	The sample passed all applicable flag tests (Pass).
	One or more possible problems exists for the associated sample (Fail). Note: The symbol displays the number of flags the sample failed.
	Omitted Well: Well omitted automatically by the algorithm Note: The symbol displays the number of flags the sample failed.
	Omitted Well: Well omitted manually by user

Note: Applied Biosystems recommends examining all samples that are flagged.

Notes _____

Customizing Flags

Most flags are a measurement of a specific aspect of the sample data. A flag is produced when the measurement exceeds a threshold, some of which you can customize to refine your analyses. In these cases, the user-defined parameters for the flags appear in the Analysis Settings dialog box for the applicable analysis type. See “Configuring Flags for Use” on page 129 for more information on entering custom thresholds.

Notes for Using Flags

- Flags appear in the results tab, the plate grid, and the QC Summary tab.
- Flags are warnings. The software does not stop the analysis if one or more samples fail the flag tests.
- Applied Biosystems recommends examining flagged results (✓).
- Holding the cursor over a column header in the Results Table displays a tooltip that lists the full name of the column (the default names are often acronyms).

Configuring Flags for Use

While viewing the desired plate document or relative quantitation (RQ) study:

1. Click  to display the Analysis Settings dialog box.
2. In the Analysis Settings dialog box, select the **Plate** tab (or select the **Study** tab if you are configuring the settings for an RQ study).
3. Using the table on page 130 as a reference, do the following for each row in the Flag Condition and Omit Settings table:
 - a. If you want the software to display the results of the flag in the Results Table, select the check box in the Flag Condition column.
 - b. Do not change the qualifying statement in the Condition column.
 - c. In the Flag Condition Value column, enter a value for the software to apply as the threshold or limit for the associated flag.
 - d. If you want the software to omit the wells that fail the flag from the analysis, select the check box in the Omit column.

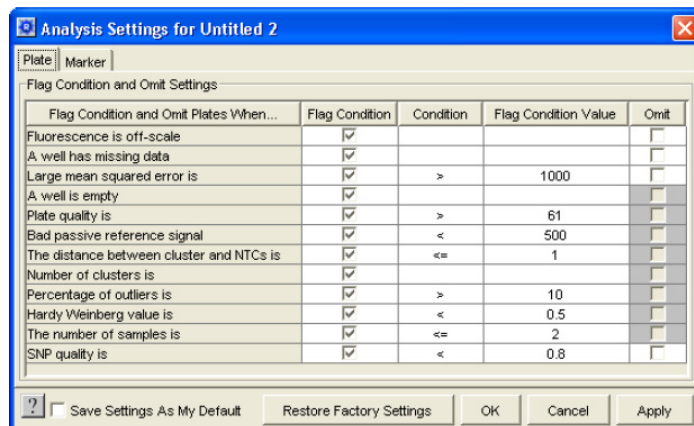

Notes

4. If you want the software to apply the current settings to all future plate documents of the same analysis type, select **Save Settings As My Default**.
5. Click **Apply** to reanalyze the plate document or study without closing the Analysis Settings dialog box, or click **OK**.

Flags By Analysis

Note: The plus/minus plate documents do not feature a system of flags.

Flags for SDS Software Version 2.3

Flags		User Configurable	Absolute Quantitation	Allelic Discrimination	Plus/Minus	Relative Quantitation		See Page
Abb.	Name					Plate Document	Study	
BAF	Baselining algorithm failed		✓				✓	132
BPR	Bad passive reference signal	✓	✓	✓		✓	✓	132
CAF	C _T calculation algorithm failed		✓				✓	133
DCN	The distance between cluster and NTCs is	✓		✓				133
EAF	Exponential region algorithm failed		✓				✓	133
EW	A well is empty	✓	✓	✓		✓	✓	134
FOS	Fluorescence is off-scale	✓	✓	✓		✓	✓	134
GBO	Well is an outlier	✓					✓	139
HMD	A well has missing data	✓	✓	✓		✓	✓	136
HNS	A well has a noise spike	✓	✓			✓	✓	136
HRN	A well has high relative noise	✓	✓			✓	✓	136
HSD	High standard deviation in replicate group	✓					✓	137
HW	Hardy Weinberg value is	✓		✓				135
LME	Large mean squared error is	✓	✓	✓		✓	✓	137
LPL	Laser power is low during the run	✓	✓			✓	✓ [‡]	138
NAP	Percentage of plate wells not amplified	✓	✓			✓	✓ [‡]	138

Notes _____

Flags for SDS Software Version 2.3

Flags		User Configurable	Absolute Quantitation	Allelic Discrimination	Plus/Minus	Relative Quantitation		See Page
Abb.	Name					Plate Document	Study	
NAW	A well is not amplified	✓	✓			✓	✓	138
NOC	Number of clusters is	✓		✓				139
POU	Percentage of outliers is	✓		✓				139
SNS	The number of samples is	✓		✓				139
TAF	Thresholding region algorithm failed		✓				✓	140

‡ Visible only when viewing study data using the Plate Centric Table Orientation.

Notes _____

Description of Flags

Baselining Algorithm Failed (BAF)

Description/Function This flag indicates that the algorithm was unable to determine the best fit baseline for the data set.

Note: The Exponential Region, Baselining, Thesholding, and C_T Calculation Algorithms are performed in sequence. If one flag fails, then the SDS software does not compute the flags for the remaining algorithms in the sequence.

- Troubleshooting**
1. Select the affected sample in the Results Table.
 2. Select the **Results** tab.
 3. In the Amplification Plot, review the amplification curves. If necessary, set the baseline and threshold manually for the affected data.

Bad Passive Reference (BPR)

Description/Function This flag indicates that the passive reference signal for the associated sample may:

- Be below normal levels
- Contain irregular fluctuations (non-uniform signal)

- Troubleshooting**
1. Confirm the results of the flag test:
 - a. Select the affected sample in the Results Table.
 - b. Select the **Results** tab.
 - c. Click  to display the Multicomponent Plot.
 - d. In the Multicomponent Plot, review the passive reference signal for irregularities.
 2. If the passive reference signal does contain inconsistencies, determine the location of the failed well in the Results Table.
 3. If the plate or TLDA used to run the sample is available, verify that the well contains fluid.

Fluctuations in the passive reference signal can be caused by:

 - An empty or leaking well
 - Formation of bubbles in the well

Notes _____

4. If the passive reference signal does not exhibit inconsistencies or abnormal behavior, consider changing the analysis settings for the flag to be less sensitive.

C_T Calculation Algorithm Failed (CAF)

Description/Function This flag indicates that the software could not calculate a C_T because of a computational error.

Note: The Exponential Region, Baseline, Thesholding, and C_T Calculation Algorithms are performed in sequence. If one flag fails, then the SDS software does not compute the flags for the remaining algorithms in the sequence.

- Troubleshooting**
1. Select the affected sample in the Results Table.
 2. Select the **Results** tab.
 3. In the Amplification Plot, review the amplification curves. If necessary, set the baseline and threshold manually for the affected data.

Distance Between Cluster and NTCs (DCN)

Description/Function This flag indicates that the associated sample is located close to the no template control (NTC) cluster, and may not have amplified well. If active, the SDS software omits all samples that do not meet condition criteria.

- Troubleshooting** Insufficient signal may be the result of poor PCR or an insufficient number of thermocycles.

Exponential Region Algorithm Failed (EAF)

Description/Function This flag indicates that the software could not identify the exponential region of the amplification curve.

Note: The Exponential Region, Baseline, Thesholding, and C_T Calculation Algorithms are performed in sequence. If one flag fails, then the SDS software does not compute the flags for the remaining algorithms in the sequence.

- Troubleshooting**
1. Select the affected sample in the Results Table.
 2. Select the **Results** tab.

Notes _____

3. In the Amplification Plot, review the amplification curves. If necessary, set the baseline and threshold manually for the affected data.

Empty Well (EW)

Description/Function This flag indicates that the software has determined the associated well to be empty because the well:

- Does not contain sample or reagents (primers and TaqMan[®] probes).
- Produced very low fluorescence (or none at all)

- Troubleshooting**
1. Confirm the results of the flag test:
 - a. Select the affected sample in the Results Table.
 - b. Select the **Results** tab.
 - c. Click  to display the Multicomponent Plot.
 - d. In the Multicomponent Plot, verify that the signals are below normal level for the plate/study.
 2. In the Results Table, determine the location of the failed well.
 3. If the plate or TLDA used to run the sample is available, verify that the well contains fluid.

Fluorescence Off-Scale (FOS)

Description/Function This flag indicates that the associated sample produced fluorescence in one or more cycles that exceeds the maximum detectable range for the 7900HT instrument (CCD saturation).

Note: Offscale data can corrupt the results of a run if the offscale data is located at a cycle that interferes with the C_T calculation.

- Troubleshooting**
1. Select the affected sample in the Results Table.
 2. Select the **Results** tab.
 3. Click  to display the Multicomponent Plot.
 4. In the Raw Data and Multicomponent Plots, evaluate the effect of the offscale data.
Does the offscale data interfere with the C_T calculation? If so, consider omitting the well from the analysis.

Notes _____

5. If possible, determine the source of the offscale result.

A variety of factors can produce offscale data including:

- Sample Overload – High concentrations of sample can produce offscale data.
- Contamination – A fluorescent contaminant on the exterior a well or within the reaction can produce consistently high signals throughout a run.

Outlier Well (GBO)

Description/Function This flag indicates that the C_T of the sample deviates significantly from those of the associated replicate group and has been identified as an outlier based on the Grubbs test (also known as the extreme studentized deviate [ESD] method for outlier removal).

Note: The algorithm does not remove samples that achieve C_T s within 0.25 of the mean for the replicate group.

Note: If two sample produce identical C_T s but are identified as outliers, then the software flags both wells.

- Troubleshooting**
1. In the SDS RQ Manager Software, note the well positions of the outlier and associated replicates.
 2. Select **Table Orientation ▶ Detector Centric**.
 3. In the upper-left pane, select the detector that the outlier evaluates to view the data for the replicate group.
 4. Select the **Amplification Plot** tab, then select **Data ▶ Ct vs. Well Position** to view the clustering of the C_T s for the replicate group.
 5. Evaluate the outlier. Omit or restore the well as necessary.

Hardy Weinberg Value (HW)

Description/Function This flag identifies samples that belong to a population that does not match Hardy Weinberg equilibrium.

- Troubleshooting** The samples may trigger this flag as a result of genuine allelic disequilibrium in the associated population or because of several experimental and technical issues.

Notes _____

Has Missing Data (HMD)

Description/Function This flag indicates that the associated sample contains one or more cycles for which no spectral data is present.

Note: Although rare, samples can contain missing data as the result of an interruption to the 7900HT instrument hardware or software during the run.

Troubleshooting

1. Select the affected sample in the Results Table.
2. Select the **Results** tab.
3. Click  to display the Multicomponent Plot.
4. In the Raw Data and Multicomponent Plots, observe the missing data.
Does the missing data interfere with the C_T calculation? If so, consider omitting the well from the analysis.

Has Noise Spike (HNS)

Description/Function This flag indicates that the amplification curve contains one or more abnormal data points which are inconsistent with the rest of the curve.

Troubleshooting

1. Select the affected sample in the Results Table.
2. Select the **Results** tab.
3. In the Amplification Plot, review the amplification curves for the noise spike. If the noise spike has biased the baselining or C_T calculations, consider omitting the well from the analysis or set the baseline and threshold manually for the affected data.
4. If no noise spikes are present, change the analysis settings for HNS to be less sensitive.

High Relative Noise (HRN)

Description/Function This flag indicates that the associated sample failed the high relative noise test. The algorithm determines the magnitude of the noise for each well based on the reporter dye signal. It also estimates the mean and standard deviation of the noise for the entire plate. The flag is evaluated by comparing the noise of the well to the plate, then determining whether or not it exceeds the threshold in the analysis settings.

Notes _____

- Troubleshooting**
1. Select the affected sample in the Results Table.
 2. Select the **Results** tab.
 3. Click  to display the Multicomponent Plot.
 4. In the Multicomponent Plot, observe the signal corresponding to the background fluorescence. If necessary, omit the well.
 5. Change the analysis settings to increase or decrease sensitivity, as desired.

High Standard Deviation in Replicate Group (HSD)

Description/Function This flag indicates that the standard deviation of the C_T s for the replicate group exceeded the criteria defined in the “High standard deviation in a replicate group” row of the Study tab in the Analysis Settings dialog box.

- Troubleshooting**
1. In the SDS RQ Manager Software, note the well positions within the outlier and associated replicates.
 2. Select **Table Orientation ▶ Detector Centric**.
 3. In the upper-left pane, select the appropriate detector to view the relevant data for the replicate group.
 4. Select the **Amplification Plot** tab, then select **Data ▶ Ct vs. Well Position** to view the clustering of the C_T s for the replicate group.
 5. Evaluate the C_T of the flagged well in relation to the replicates. Omit or restore the well as necessary.

Large Mean Squared Error (LME)

Description/Function This flag indicates that the associated sample failed the Mean Squared Error test. To perform the test, the software compares the maximum value for the mean squared error for the well to the criteria defined in the “Large Mean squared error is” row the Analysis Settings dialog box. If the statement evaluates *True*, then the software flags the well.

- Troubleshooting**
1. Select the affected sample in the Results Table.
 2. Select the **Results** tab.
 3. Click  to display the Multicomponent Plot.

Notes _____

4. In the Multicomponent Plot, observe the MSE curve in the plot.

Factors that can produce a Large Mean Squared Error include:

- Improper Pure Dye Calibration
- Incorrect dyes specified in setup
- Offscale fluorescence

Laser Power Low (LPL)

Description/Function This flag indicates that the power supplied to the laser of the 7900HT instrument decreased below the acceptable level at least once during the associated run.

Note: Applicable only to runs performed with version 2.3 and later of the SDS Software.

Troubleshooting Open the log file for the appropriate 7900HT Fast System and confirm the loss of power during the associated run.

IMPORTANT! If the loss of laser power is consistent and is observed over multiple runs, an instrument component may be nearing the end of its life and require service or replacement.

Non-Amplified Plate (NAP)

Description/Function This flag indicates that the percentage of wells on the plate that did not amplify exceeded the threshold defined in the “Percentage of plate wells not amplified” row of the Analysis Settings dialog box.

Note: Empty wells are not included in the test.

Troubleshooting Review the data of the wells that failed to amplify (flagged as NAW).

Not Amplified Well (NAW)

Description/Function This flag indicates that the associated sample failed to amplify. To determine this, the algorithm calculates the difference between the signal at the beginning of the run and the signal at the end of the run.

Applied Biosystems recommends using the default setting for the NAW calculation. To customize the setting, perform successive analyses of your data set using different settings and adjust the setting according to the desired sensitivity.

Notes _____

- Troubleshooting**
1. Select the affected sample in the Results Table.
 2. Select the **Results** tab.
 3. Observe the signals in the Amplification Plot. If necessary, omit the well.

Number of Clusters (NOC)

Description/Function This flag indicates that the number of clusters in the data set (excluding the NTC cluster) is outside the threshold range defined in the “Number of clusters is” row of the Analysis Settings dialog box.

- Troubleshooting**
1. Select the affected sample in the Results Table.
 2. Select the **Results** tab.
 3. In the Allele Plot, observe the data point in relation to the related cluster. If necessary, omit the well.

Percentage of Outliers (POU)

Description/Function This flag indicates that the percentage of outliers on the plate exceeds the threshold defined in the “Percentage of outliers is” row of the Analysis Settings dialog box.

Small Number of Samples in Cluster (SNS)

Description/Function This flag indicates that the number of data points in the cluster is less than the threshold defined in the “The number of samples is” row of the Analysis Settings dialog box.

The software can flag wells as the result of:

- Low allele frequency
- Small sample population
- Outliers mistakenly identified as a cluster (one or two samples in a cluster may in fact be an outlier)

- Troubleshooting** Review the calls and/or re-run the plate.

Notes _____

Thresholding Algorithm Failed (TAF)

Description/Function This flag indicates that the software could not calculate a threshold because of a computational error.

Note: The Exponential Region, Baseline, Thresholding, and C_T Calculation Algorithms are performed in sequence. If one flag fails, then the SDS software does not compute the flags for the remaining algorithms in the sequence.

- Troubleshooting**
1. Select the affected sample in the Results Table.
 2. Select the **Results** tab.
 3. In the Amplification Plot, review the amplification curves. If necessary, set the baseline and threshold manually for the affected run.

Notes _____

Adding Custom Dyes to the Pure Dye Set

The Applied Biosystems 7900HT Fast Real-Time PCR System can be used to run assays designed with custom dyes (dyes not manufactured by Applied Biosystems). However, before using custom dyes with the 7900HT Fast System, you must create and run a pure dye plate made with the custom dyes. The purpose of the custom pure dye plate is similar to that of a standard pure dye plate: the SDS software uses the custom pure dye plate to create a spectral standard to distinguish the custom dye.

IMPORTANT! To use a custom dye on your 7900HT Fast System, it must fluoresce within the spectral range measured by the instrument. The working range of the CCD camera is 500 to 660 nm.

Before You Begin

Materials Required

You need the materials listed below to perform this procedure.

Powder-free gloves and safety goggles

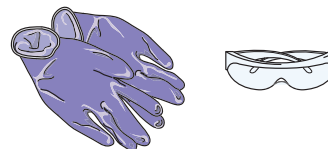

Reaction plates appropriate for your sample block:

- Standard 384-well reaction plates
- Standard 96-well reaction plates
- Fast 96-well reaction plates

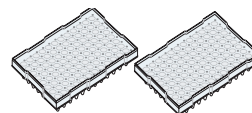

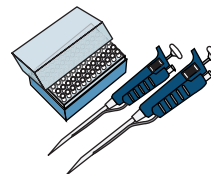

Note: You cannot create custom dyes for the TaqMan® Low Density Array Block.

Pipettors and pipet tips (100- μ L)

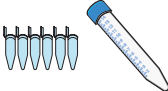
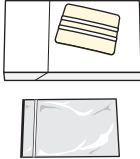

Notes _____

Water, deionized	
Custom dyes	
Tubes (2-mL and 10-mL)	
Optical adhesive covers or Optical Caps (PN 4323032)	
Centrifuge, with plate adapter	

Notes _____

Workflow To add custom dyes to the pure dye set:

1. Obtain the tools and materials required (see [pages 141 and 142](#)).
2. Create a dilution series plate for each custom dye you want to add to the pure dye set (see [page 144](#)).
3. Create a plate document for the dilution series plate (see [page 144](#)).
4. Run and analyze the dilution series plate (see [page 145](#)).
5. Create a pure dye plate with the custom dye(s) (see [page 148](#)).
6. Add the custom dye(s) to the SDS software (see [page 149](#)).
7. Create a plate document template with the custom dye(s) (see [page 150](#)).

Notes _____

Creating a Dilution Series Plate

1. In the center wells of a reaction plate, prepare a dilution series of the custom dye (for example 25, 50, 100, 200, 400, 800, 1600, and 3200 nM concentration):
 - For a standard 384-well or Fast 96-well reaction plate, use 20 μ L per well
 - For a standard 96-well reaction plate, use 50 μ L per well

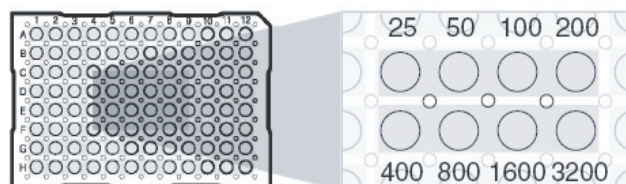

2. Seal the wells of the reaction plate using an optical adhesive cover or Optical Caps (PN 4323032).

IMPORTANT! Do not use MicroAmp[®] caps (domed) or Optical Tubes with the 7900HT Fast System. You can use Optical Caps (PN 4323032) (ONLY on the standard 96-well reaction plates) with the 7900HT Fast System.

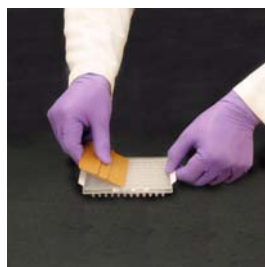

3. Repeat this procedure for each custom dye you wish to add to the pure dye set.

Creating a Plate Document for the Dilution Series Plate

1. Double-click  on the desktop (or select **Start > All Programs > Applied Biosystems > SDS 2.3 > SDS 2.3**) to start the SDS software.

2. If the login option is enabled, the Login dialog box appears. Enter your **User Name** and **Password**, then click **OK**.

Note: If the login option is not enabled, no Login dialog box appears. Skip to [step 3](#) below.

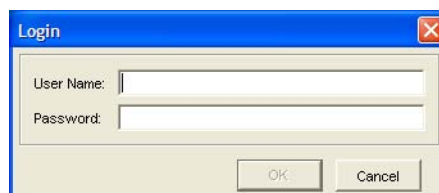

3. From the SDS software menu bar, click  (or select **File ▶ New**).

Notes _____

4. Complete the New Document dialog box:
 - a. Assay – Select **Allelic Discrimination**.
 - b. Container – Select the appropriate format.
 - c. Template – Select **Blank Template**.
 - d. Barcode – Leave this field blank.
 - e. Click . The software creates and opens a new plate document.

Note: It is not necessary to configure detector, sample, or method information for the dilution series plate document. The purpose of the run is to establish the correct working concentration for the dye by viewing the intensity of the raw spectra produced by the wells in the dilution series.

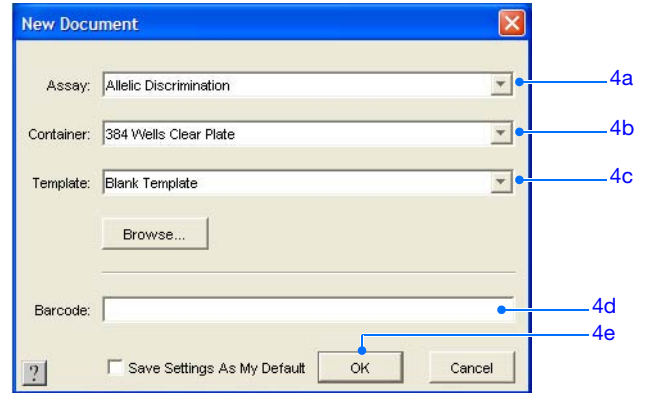

5. Repeat this procedure for each dilution series plate you created.

Running and Analyzing the Dilution Series Plate

1. In the plate document, select the **Instrument > Plate Read** tabs.
2. Click **Open/Close**. The instrument tray rotates to the OUT position.

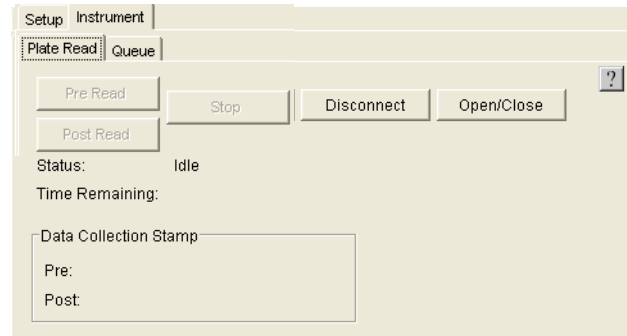

Notes _____

- Place the prepared series dilution plate into the instrument tray as shown.

IMPORTANT! The A1 position is located in the top-left side of the instrument.

Standard 384-well reaction plate

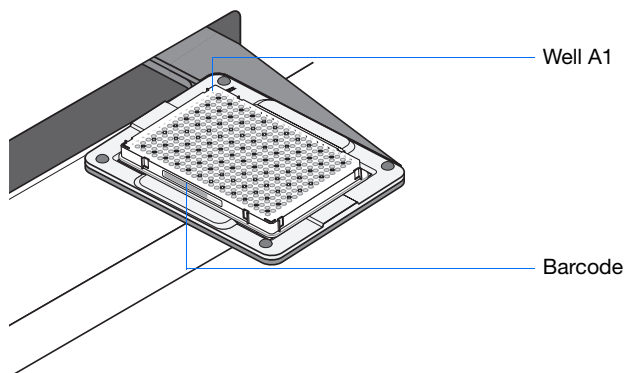

- Click **Post Read**. The instrument tray rotates to the IN position and the instrument performs the run.

As the instrument performs the run, it displays status information in the Plate Read tab.

After the run, the status values and buttons are grayed-out, the Analysis button is enabled (▶), and a message indicates whether or not the run is successful.

- Click **Open/Close** to eject the reaction plate.
- Click ▶ (or select **Analysis ▶ Analyze**). The software analyzes the raw run data.
- Click 📄 (**Show System Raw Data Pane**).

Notes _____

8. In the Raw Data Plot, determine the highest concentration of dye that does not produce a saturated signal, then record it for future use.

Saturated signals are characterized by their high peaks that rise beyond detectable levels (> 65,000 fluorescent units) and appear as plateaus on the Raw Data plot.

The concentration of the custom dye that yields the highest possible signal but does not saturate is the maximum concentration for use with the 7900HT Fast System.

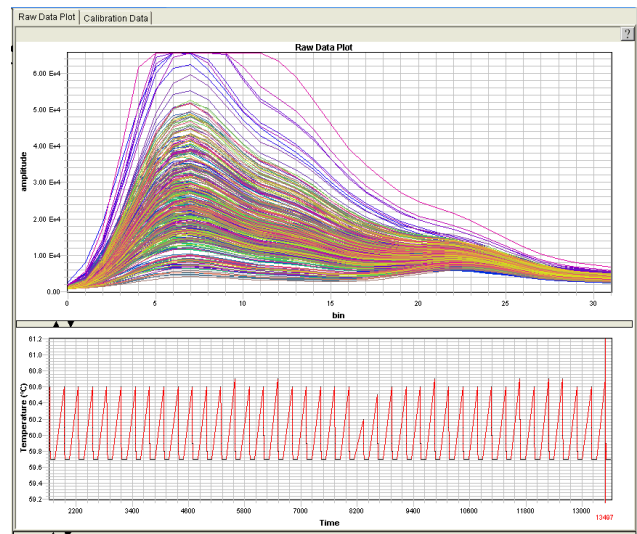

9. Repeat this procedure for each dilution series plate you created.

Notes _____

Creating a Pure Dye Plate with the Custom Dye(s)

1. Prepare 5 mL of a custom dye at the concentration determined in [step 8 on page 147](#).
2. Pipet the diluted custom dye to at least three columns of a reaction plate, as shown at right.

IMPORTANT! The optical configuration of the 7900HT instrument requires that each custom dye occupy at least three columns of the reaction plate to permit adequate data collection.

- For a standard 384-well or Fast 96-well reaction plate, pipet 20 μ L per well
- For a standard 96-well reaction plate, pipet 50 μ L per well

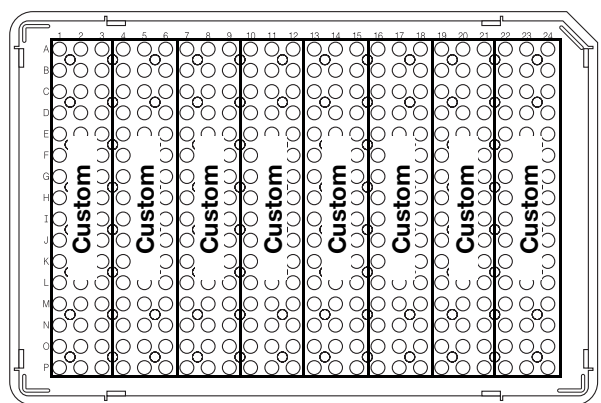

3. Repeat [steps 1 through 2](#) for each custom dye you wish to add to the reaction plate.
4. Seal the wells of the reaction plate using an optical adhesive cover or Optical Caps (PN 4323032).

IMPORTANT! Do not use MicroAmp[®] caps (domed) or Optical Tubes with the 7900HT Fast System. You can use Optical Caps (PN 4323032) (ONLY on the standard 96-well reaction plates) with the 7900HT Fast System.

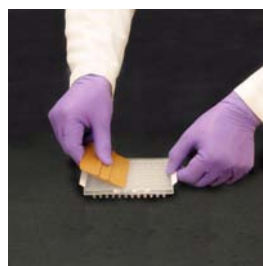

Notes _____

Adding the New Custom Dye(s) to the SDS Software

1. From the SDS software menu bar, select **Tools > Dye Manager**.
2. In the Dye Manager dialog box, click .

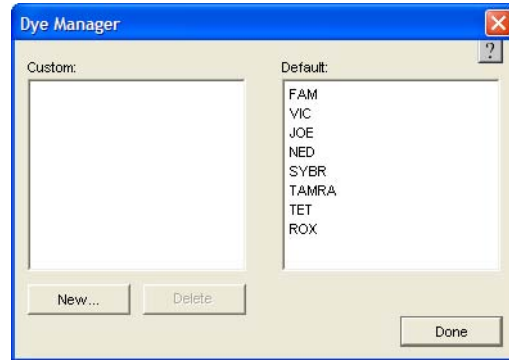

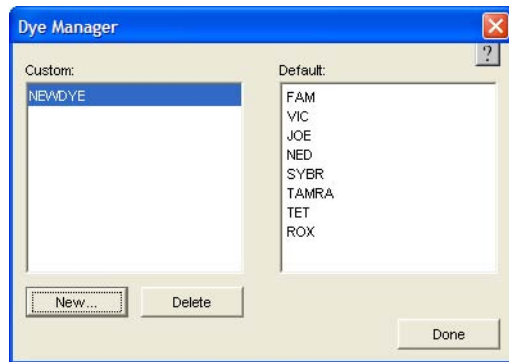
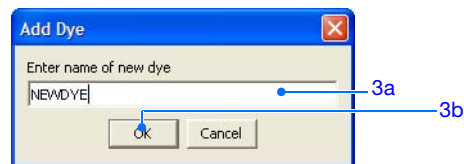

3. In the Add Dye dialog box:
 - a. Enter a name for the custom dye.
 - b. Click . The new dye appears in the Dye Manager's Custom dye list.



4. Repeat [steps 1 through 3](#) for each custom dye you added to the custom pure dye plate ([page 148](#)).
5. Click . The SDS software makes the new dye(s) available to pure dye plate documents.

Notes _____

Creating a Plate Document Template with the Custom Dye(s)

1. Click  (or select **File ▶ New**).
2. Complete the New Document dialog box:
 - a. Assay – Select **Pure Spectra**.
 - b. Container – Select the appropriate format.
 - c. Template – Select **Blank Template**.
 - d. Barcode – Leave this field blank.
 - e. Click . The software creates and opens a new plate document.

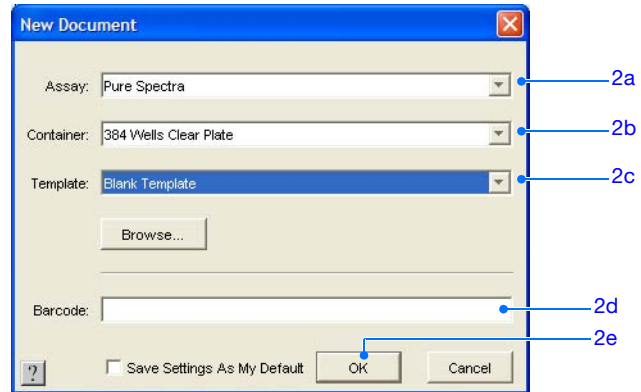

3. Apply the new custom dye(s) to the plate document:
 - a. Select the wells containing the first custom dye.
 - b. Select the **Setup** tab.
 - c. In the Dyes drop-down list, select the appropriate dye. The software applies the dye to the selected wells.
 - d. Repeat steps a and b to configure the plate document with any additional custom dyes.

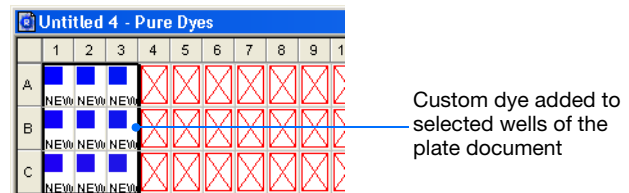
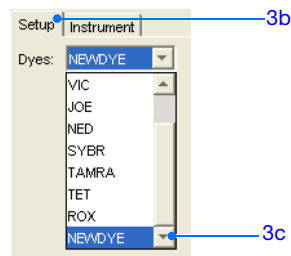

Notes _____

4. Save the custom pure dye plate document as a plate document template:

- a. Click  (or select **File > Save**) to open the Save As dialog box.
- b. In the Save in field, navigate to and open **AppliedBiosystems ▶ SDS2.3 ▶ Templates**.

Note: By saving the plate document template to the Templates directory, it becomes available from the Template drop-down list in the New Document dialog box.

- c. In the File name field, enter a name for the plate document template.
- d. Select **SDS 7900HT Template Document (*.sdt)** from the Files of type drop-down list.
- e. Click . The software saves the plate document as a plate document template.

5. To run the custom dyes, see [“Performing a Pure Dye Calibration”](#) on page 17.

4b. This should be Templates

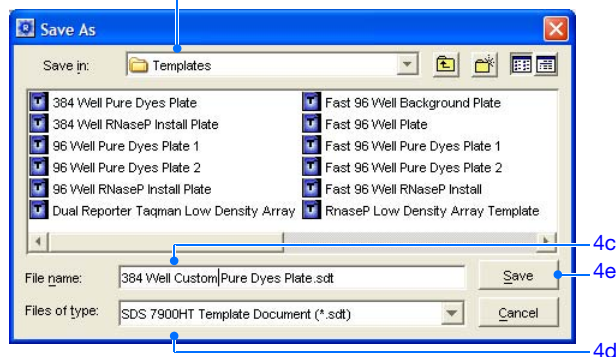

Notes _____

Appendix A

Creating a Plate Document Template with the Custom Dye(s)

Notes _____

Instrument Connections

Electrical Connections Figure B-1 and Table B-1 illustrate the electrical connections of the Applied Biosystems 7900HT Fast Real-Time PCR System components.

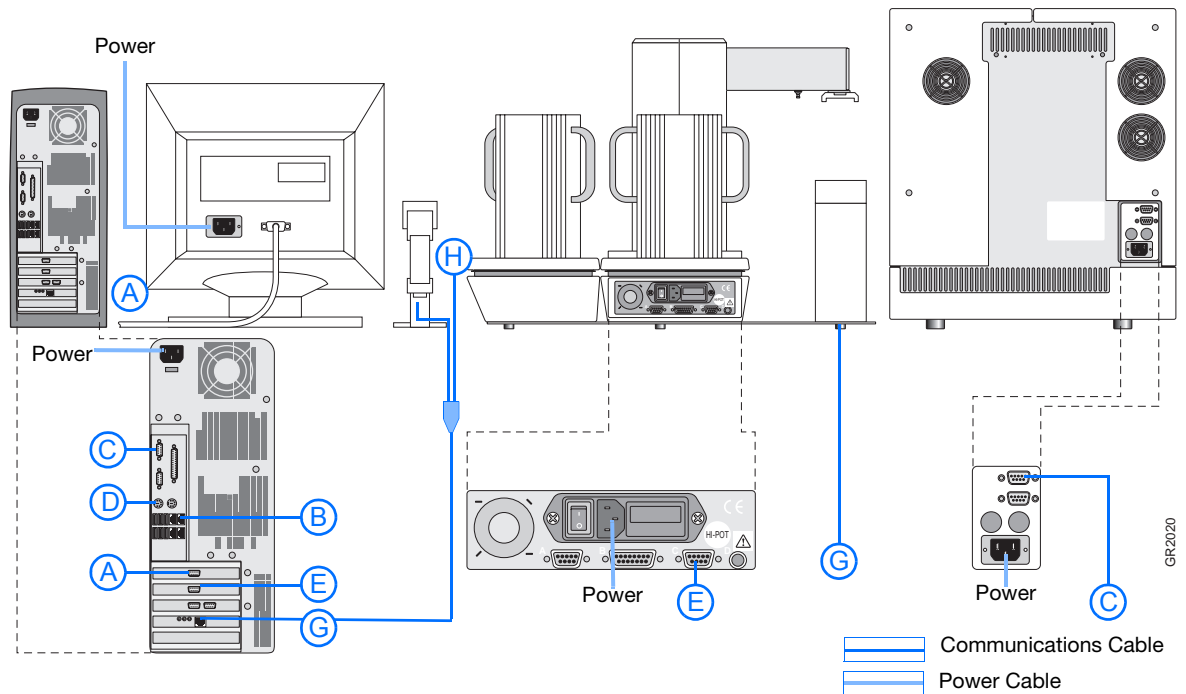

Figure B-1 Connections of the 7900HT Fast System

Table B-1 Connections of the 7900HT Fast System

Cable	Type	Connects...	To...
A	Communication	Computer (Monitor Port)	Monitor
B	Comm/Power	Computer (Mouse Port)	Mouse (not shown)
C	Serial	Computer (Serial Port 1)	7900HT Instrument
D	Comm/Power	Computer (Keyboard Port)	Hand-held Bar Code Reader
E	Communication	Computer (Serial Port 2)	Plate Handler (Port C)
G [‡]	Comm/Power	Computer (ISA Card 1)	Fixed-Position Bar Code Reader
H	Comm/Power	Bar Code Reader Cable	Keyboard (not shown)

[‡]See Figure B-2 on page B-154.

Notes

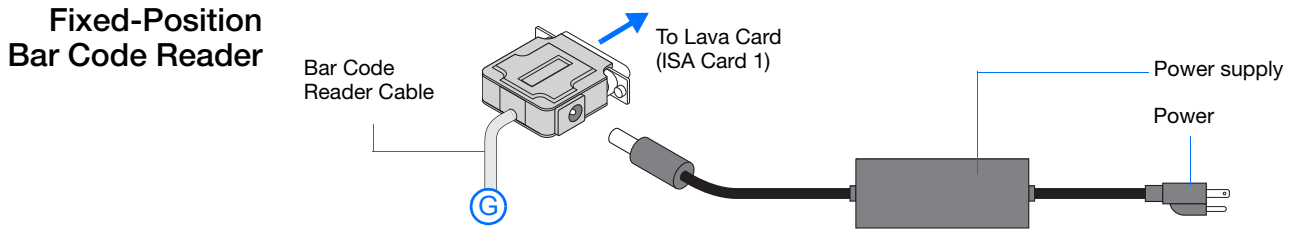

Figure B-2 Fixed-position bar code reader connection

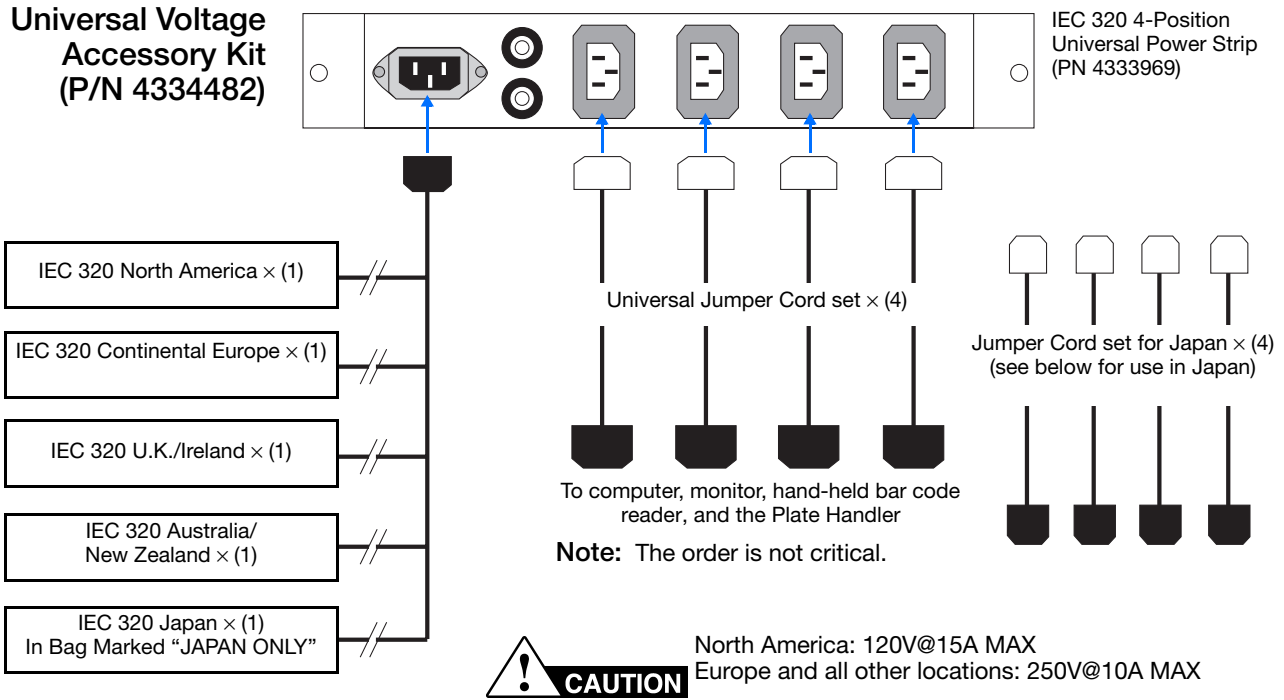

Figure B-3 Universal power strip

To install the Universal Voltage Accessory Kit (All Countries Except Japan):

1. Connect one universal jumper to each accessory (see below for use in Japan).
2. Connect the other end of the power jumpers to the power strip outputs.
3. Choose the correct country specific power input cord for the geographical region and connect it to the power strip input.
4. Power off all instrument accessories (monitor, computer, and Plate Handler).
5. Connect the power-input cord to the AC outlet.

Notes _____

6. Power on accessories.
7. Discard unused cord sets.

Usage Guidelines for Japan

1. Use only the cord sets supplied in the bag marked “JAPAN ONLY.”
2. Discard all other unused cord sets.

Notes _____

Notes _____

Parts and Consumables

Note: Part numbers listed in this appendix are for customers inside the United States. Contact your Regional Sales Office for local Part numbers and prices. See “How to Obtain Support” on page vii.

Interchangeable Sample Block Modules and Accessories

The Applied Biosystems 7900HT Fast Real-Time PCR System features a Peltier-based, interchangeable sample block based on the technology established in the GeneAmp® PCR System 9700 thermal cycler.

The use of an interchangeable sample block:

- Reduces instrument downtime by allowing immediate replacement of the block.
- Permits easy access to the sample block for troubleshooting and maintenance.
- Supports multiple consumable formats.
- Provides several different modes of operation (including Max mode and programmable temperature ramps).

Table C-1 Sample block modules and accessories

Part No.	Description	Quantity
4331406	7900HT System Standard 384-Well Block Upgrade Kit Includes a Standard 384-Well Block, a 384-Well Plate Adapter, and a Sequence Detection Systems 384-Well Spectral Calibration Kit (PN 4323977)	1 kit
4331405	7900HT System Standard 96-Well Block Upgrade Kit Includes a Standard 96-Well Block, a 96-Well Plate Adapter, and an ABI PRISM® 7900HT Sequence Detection Systems 96-Well Spectral Calibration Kit (PN 4328639)	1 kit
4351402	7900HT System Fast 96-Well Block Upgrade Kit Includes a Fast 96-Well Block, a Fast 96-Well Plate Adapter, a 7900HT System Fast 96-Well Spectral Calibration Kit (PN 4351653), a TaqMan® RNase P Fast 96-Well Instrument Verification Plate (PN 4351979), and a TaqMan® Fast Reagents Starter Kit (PN 4352407)	1 kit

Notes _____

Table C-1 Sample block modules and accessories (continued)

Part No.	Description	Quantity
4329012	7900HT System TaqMan® Low Density Array Upgrade Includes a TaqMan® Low Density Array Block, microfluidic card sealer, centrifuge buckets and adapters, and a chemistry installation kit.	1 kit

Consumables and Disposables

The 7900HT Fast System can run:

- 384-Well Optical Reaction Plates (also referred to as *standard 384-well reaction plates*) sealed with optical adhesive covers
- MicroAmp® 96-Well Optical Reaction Plates (also referred to as *standard 96-well reaction plates*) sealed with optical adhesive covers or Optical Caps (PN 4323032, flat cap strips only)
- Optical 96-Well Fast Thermal Cycling Plates (also referred to as *Fast 96-well reaction plates*) sealed with optical adhesive covers
- TaqMan® Low Density Arrays

The optical plates recommended above are designed specifically for fluorescence-based PCR chemistries and are frosted to minimize external fluorescent contamination. Before running prepared optical plates on the 7900HT instrument, each plate must be sealed with the optical adhesive covers recommended above. Applied Biosystems optical adhesive covers are specifically designed to permit the transmission of light to and from the wells of the optical plate.

IMPORTANT! Do not use MicroAmp® caps (domed) or Optical Tubes with the 7900HT Fast System. You can use Optical Caps (PN 4323032) (ONLY on the standard 96-well reaction plates) with the 7900HT Fast System.

Table C-2 Consumables and disposables for the 7900HT instrument

Part No.	Description	Quantity
Optical Adhesive Covers		
4313663	ABI PRISM® Optical Adhesive Cover Starter Kit Includes 20 ABI PRISM® Optical Adhesive Covers, an Applicator, and an ABI PRISM® Optical Cover Compression Pad.	20 Covers
4311971	ABI PRISM® Optical Adhesive Covers	100 Covers
4360954	Optical Adhesive Covers	25 Covers

Notes _____

Table C-2 Consumables and disposables for the 7900HT instrument (*continued*)

Part No.	Description	Quantity
4323032	Optical Caps, 8 Caps/Strip	300 Strips/ Pkg 2400 Caps/ Pkg
Standard 384-Well Reaction Plates		
4309849	384-Well Clear Optical Reaction Plate with Barcode (code 128)	50 Plates
4326270	384-Well Clear Optical Reaction Plate with Barcode (code 128), 10-Pack Includes 10 of PN 4309849, 384-Well Clear Optical Reaction Plates with Barcode	500 Plates
Standard 96-Well Reaction Plates		
4306737	MicroAmp [®] 96-Well Optical Reaction Plate with Barcode (code 128)	20 Plates
4326659	MicroAmp [®] 96-Well Optical Reaction Plate with Barcode (code 128), 25-Pack Includes 25 of PN 4306737, MicroAmp [®] 96-Well Optical Reaction Plates with Barcode	500 Plates
4314320	MicroAmp [®] 96-Well Optical Reaction Plate with Barcode (code 128) and ABI PRISM [®] Optical Adhesive Covers Includes 100 ABI PRISM [®] Optical Adhesive Covers (PN 4311971) and 5 of PN 4306737, MicroAmp [®] 96-Well Optical Reaction Plates with Barcode	100 Plates 100 Covers
4312063	MicroAmp [®] Splash Free Support Base for 96-Well Reaction Plates	10 Bases
Fast 96-Well Reaction Plates		
4346906	Optical 96-Well Fast Thermal Cycling Plate with Barcode (code 128)	20 Plates
4312063	MicroAmp [®] Splash Free Support Base for 96-Well Reaction Plates	10 Bases
TaqMan[®] Low Density Arrays		
---	TaqMan [®] Low Density Arrays	Variable*

* See the Applied Biosystems Web site.

Notes _____

Instrument Maintenance and Verification

The following sequence detection kits and reagents are used to perform routine maintenance on and verify the function of the 7900HT Fast System.

Table C-3 Consumables for calibration and verification runs

Part Number	Description	Quantity
Sequence Detection Systems Calibration Kits		
4328639	ABI PRISM® 7900HT Sequence Detection Systems 96-Well Spectral Calibration Kit Includes three MicroAmp® 96-Well Optical Reaction Plates: one preloaded and sealed background plate, and two preloaded and sealed pure dye plates containing eight separate dye standards (FAM™, JOE™, NED™, ROX™, SYBR® Green, TAMRA™, TET™, VIC®).	3 x 96-Well Plates
4323977	Sequence Detection Systems 384-Well Spectral Calibration Kit Includes two 384-Well Optical Reaction Plates: one preloaded and sealed background plate and one preloaded and sealed pure dye plate containing eight separate dye standards (FAM, JOE, NED, ROX, SYBR Green, TAMRA, TET, VIC).	2 x 384-Well Plates
4351653	7900HT System Fast 96-Well Spectral Calibration Kit Includes three Optical 96-Well Fast Thermal Cycling Plates: one preloaded and sealed background plate, and two preloaded and sealed pure dye plates containing eight separate dye standards (FAM™, JOE™, NED™, ROX™, SYBR® Green, TAMRA™, TET™, VIC®).	3 x 96-Well Plates
4362745	TaqMan® Low Density Array Spectral Calibration Kit Includes four empty TaqMan® Low Density Arrays (TLDA) and four tubes: one background solution, one FAM™ dye, one ROX™ dye, and one VIC® dye.	4 x TLDA
Instrument Verification Plates		
4310982	TaqMan® RNase P Instrument Verification Plate Includes one MicroAmp® 96-Well Optical Reaction Plate. Each well contains preloaded reaction mix (master mix, RNase P primers, and FAM™ dye-labeled probe) and template to detect and quantitate genomic copies of the human RNase P gene.	1 x 96-Well Plate
4323306	TaqMan® RNase P 384-Well Instrument Verification Plate Includes one 384-Well Optical Reaction Plate. Each well contains preloaded reaction mix (master mix, RNase P primers, and FAM™ dye-labeled probe) and template to detect and quantitate genomic copies of the human RNase P gene.	1 x 384-Well Plate

Notes _____

Table C-3 Consumables for calibration and verification runs (continued)

Part Number	Description	Quantity
4351979	TaqMan® RNase P Fast 96-Well Instrument Verification Plate Includes one Optical 96-Well Fast Thermal Cycling Plate. Each well contains preloaded reaction mix (master mix, RNase P primers, and FAM™ dye-labeled probe) and template to detect and quantitate genomic copies of the human RNase P gene.	1 x 96-Well Plate
4351468	TaqMan® Low Density Array RNase P Kit Includes one empty TaqMan® Low Density Array (TLDA) and eight tubes of solution. Each solution contains reaction mix (master mix, RNase P primers, and FAM™-MGB dye-labeled probe) and template to detect and quantitate genomic copies of the human RNase P gene.	1 TLDA

Notes _____

Appendix C

Instrument Maintenance and Verification

Notes _____

A

- absolute quantification
 - troubleshooting 124
- adjusting
 - plate-sensor switch 92 to 96
- adjustment knob 89
- air bubbles 121
- aligning
 - CLV fixed-position bar code reader 112 to 113
 - fixed-position bar code readers 110
 - LD fixed-position bar code reader 114 to 116
 - Plate Handler 97 to 108
- amplification run
 - starting 145
- analyzing
 - background data 14
 - pure dye data 29
- Applied Biosystems
 - contacting vii
 - customer feedback on documentation vii
 - Information Development department vii
 - Technical Support vii
- assumptions for using this guide v
- Automation Accessory
 - components 89
 - Plate Handler, *See Plate Handler*
 - See fixed-position bar code reader*

B

- background calibration
 - about 3, 17
 - analyzing the data 14
 - creating the plate document 10
 - preparing the plate 6
 - running the plate 12
 - when to perform 3, 17
- background component, about 3
- background plate
 - creating 8
 - preparing 6
 - running 12
- background run
 - troubleshooting 15
- backing up SDS files 73
- backup storage devices 73

- bold text, when to use v

C

- calibrating the 7900HT instrument
 - adjusting the plate-sensor switch 92
 - aligning the fixed-position bar code readers 110
 - aligning the Plate Handler 97
- calibration
 - background 3, 17
- CAUTION, description vi
- changing
 - gripper finger pads 90
 - sample block module 53
- chemistry
 - non-optimized 121
 - troubleshooting 120 to 123
- cleaning
 - gripper finger pads 91
 - sample block wells 66, 67
- computer
 - troubleshooting 84
- consumables
 - Fast 96-well reaction plates 159
 - improper or damaged plastics 123
 - Optical Adhesive Covers 158
 - Optical Cap Strips 158
 - standard 384-well reaction plates 159
 - standard 96-well reaction plates 159
 - TaqMan Low Density Arrays 159
 - writing on reaction plates 122
- contamination
 - decontaminating the sample block 65
 - fluorescent, common sources 122
 - isolating on the sample block module 15
- conventions
 - bold text v
 - for describing menu commands v
 - IMPORTANT! vi
 - in this guide v
 - italic text v
 - Notes v
 - user attention words v
- creating
 - background plate 8
 - background plate document 10
 - custom pure dye plate documents 150
 - pure spectra plate document 24

- verification run plate document 41
- custom pure dyes 141
- customer feedback, on Applied Biosystems documents vii

D

- data management 73
- decontaminating the sample block module 65 to 66
- documentation, related vi

F

- finger pads
 - cleaning 91
 - replacing 90
- fixed-position bar code reader
 - aligning CLV 112 to 113
 - aligning LD 114 to 116
 - connections 153
- fluorescent
 - contamination 122
 - detection system 153

G

- gripper 89

H

- hand-held bar code reader
 - connections 153

I

- imprecise pipetting 121
- improper threshold setting 120
- Information Development department, contacting vii
- installing
 - plate adapter 62
 - sample block module 53
 - SDS software 83
 - SDS Software Updates 83
 - Windows service pack updates 83
- instrument
 - troubleshooting 84
- instrument tray
 - replacing the plate adapter 62
- irreproducibility
 - causes 120 to 123
- italic text, when to use v

L

- LAVA software
 - aligning the CLV fixed-position bar code

- reader 112 to 113
- launching 112, 114
- LDHOST software
 - aligning the LD fixed-position bar code reader 114 to 116
- low copy templates 123

M

- maintenance schedule 52, 72, 88
 - calibration and verification runs 2
- master mixes
 - using 121
- menu commands, conventions for describing v
- modes of operation 74
 - automated 75
 - stand-alone 74
- MSDSs, obtaining vi, vii

P

- performing
 - background calibration 6
 - pure dye run 21
- pipetting errors 121
- pipettors, using 121
- plate adapter, changing 62
- plate document
 - background 10
 - pure spectra 24
 - verification run 41
- Plate Handler 89
 - adjustment knob 89
 - aligning 97 to 108
 - cleaning the finger pads 91
 - gripper 89
 - plate stack positions 89
 - plate-sensor switch 89
 - replacing the finger pads 91
- plate stacks
 - positions 89
- plate-sensor switch 89
 - adjusting 92 to 96
- precision
 - causes of low precision 120 to 123
- preparing
 - background plate 6
 - pure dye plates 21
 - RNase P plate 37
 - RNase P TLDA 39
- process quality values (PQV)
 - rules for 129
- pure dye calibration
 - analyzing the data 29
 - running the plate 27

pure dye plate
 constructing for custom dyes 141
 running 27

pure dye run
 troubleshooting 31

pure spectra calibration
 about 17
 creating the plate document 24
 preparing pure dye plates 21

R

reagents
 non-Applied Biosystems PCR reagents 123
 TaqMan RNase P Instrument Verification Plates 160

reinstalling the SDS software 83

relative quantification
 troubleshooting 124

replacing
 gripper finger pads 90, 91
 sample block module 53

RNase P plate
 running 43

RNase P TLDA
 running 43

RNase P verification run
 preparing the plate 37
 preparing the RNase P TLDA 39

running
 background plate 12
 pure dye plate 27
 RNase P plate 43
 RNase P TLDA 43

S

sample block locking bar 57

sample block locking bolt 57

sample block module
 cleaning sample block module wells 66, 67
 contamination 122
 replacing 53

saturation, signal 147

SDS software
 installing 83
 reinstalling 83

signal saturation 147

software, starting 10, 24, 41, 56, 60, 63, 79, 81, 82, 99, 111, 144

spectral calibration, See *pure dye runs*

storage devices, backup 73

T

TaqMan Low Density Array RNase P Kit
 about 34

TaqMan RNase P Instrument Verification Plates
 about 32
 analyzing 47
 kits 160

Technical Support, contacting vii

text conventions v

threshold
 improper setting 120

TLDA RNase P card
 about 34

training, information on vii

troubleshooting
 7900HT instrument 84
 background runs 15
 chemistry problems 120 to 123
 computer 84
 end-point runs 126
 fixed-position bar code reader 117
 pure dye runs 31
 real-time runs 124
 SDS software 84
 Zymark Twister Microplate Handler 117

U

updating
 SDS Software 83
 Windows operating system 83

user attention words, described v

V

verification run
 creating the plate document 41
 running the RNase P plate or RNase P TLDA 43

W

WARNING, description vi

Windows service pack updates, installing 83

Z

Zymark Twister Software
 aligning the Plate Handler 97 to 108
 testing the plate sensor switch 95

Worldwide Sales and Support

Applied Biosystems vast distribution and service network, composed of highly trained support and applications personnel, reaches 150 countries on six continents. For sales office locations and technical support, please call our local office or refer to our Web site at www.appliedbiosystems.com.

Applied Biosystems is committed to providing the world's leading technology and information for life scientists.

Headquarters

850 Lincoln Centre Drive
Foster City, CA 94404 USA
Phone: +1 650.638.5800
Toll Free (In North America): +1 800.345.5224
Fax: +1 650.638.5884

06/2010