



**Promega**

# Technical Manual

---

## **Flexi® Vector Systems**

INSTRUCTIONS FOR USE OF PRODUCTS C8640, C8820 AND C9320.



[www.promega.com](http://www.promega.com)

# Flexi<sup>®</sup> Vector Systems

All technical literature is available on the Internet at [www.promega.com/tbs](http://www.promega.com/tbs)  
Please visit the web site to verify that you are using the most current version of this  
Technical Manual. Please contact Promega Technical Services if you have questions on use  
of this system. E-mail [techserv@promega.com](mailto:techserv@promega.com).

1. Description.....	2
2. Product Components and Storage Conditions .....	4
3. General Considerations .....	5
4. Cloning PCR Products into the Flexi <sup>®</sup> Vectors (Entry Reaction) .....	8
A. Purification of PCR Products.....	8
B. Restriction Digest of PCR Product and Acceptor Flexi <sup>®</sup> Vector .....	10
C. Cleanup of PCR Products .....	11
D. Ligation of PCR Product and Acceptor Flexi <sup>®</sup> Vector .....	12
E. Transformation .....	12
F. Screening for the Desired Clone .....	12
5. Transfer of Protein-Coding Regions Between Flexi <sup>®</sup> Vectors .....	13
A. Transfer of Protein-Coding Regions Between Flexi <sup>®</sup> Vectors Expressing Native or N-Terminal Fusion Proteins .....	13
B. Transfer Protocol from Native or N-Terminal Flexi <sup>®</sup> Vectors to C-Terminal Flexi <sup>®</sup> Vectors .....	15
6. Troubleshooting .....	19
7. References .....	21
8. Composition of Buffers and Solutions .....	21
9. Appendix.....	22
A. Flexi <sup>®</sup> Vector Systems Technology .....	22
B. Flexi <sup>®</sup> Vector and HaloTag <sup>®</sup> Flexi <sup>®</sup> Vector Descriptions.....	24
C. PCR Primer Design .....	30
D. Protocol for Screening Clones with SgfI and PmeI.....	32
E. Purification of a PCR Product From an Agarose Gel Slice .....	32
F. Centrifugation and Vacuum Protocols for PCR Product Purification .....	33
G. Transformation Protocol .....	36
H. Efficiency of Recovery of DNA Fragments .....	37
I. Related Products.....	38



## 1. Description

The Flexi<sup>®</sup> Vector Systems<sup>(a-d)</sup> facilitate the study of multiple facets of protein function by reducing the cloning burden of shuttling protein-coding regions between vectors with different functional capabilities. Once your protein-coding region is cloned into a Flexi<sup>®</sup> Vector, you can easily shuttle it into many other Flexi<sup>®</sup> Vectors without resequencing. This easy shuttling allows you to compare various expression systems and obtain your best yields and results. Any Flexi<sup>®</sup> Vector can act as an acceptor of a protein-coding sequence flanked by SgfI and PmeI sites. All Flexi<sup>®</sup> Vectors contain a lethal gene, barnase, which must be replaced with an insert for the desired clone to survive, allowing high-efficiency transfer of a protein-coding region between vector backbones. Antibiotic resistance genes carried on the Flexi<sup>®</sup> Vectors facilitate the transfer of protein-coding regions between vectors (Figures 1 and 2). Vectors are available as either ampicillin-resistant or kanamycin-resistant plasmids. The Flexi<sup>®</sup> Vectors are sold separately.

Unlike site-specific recombination vector systems, the Flexi<sup>®</sup> Vector Systems do not require appending multiple amino acids to the amino or carboxy termini of the protein of interest. The systems do not require an archival entry vector and, for most applications, allow direct entry into the type of vector suited to the experimental design (e.g., mammalian expression or N-terminal, glutathione-S-transferase (GST) fusion vectors).

Any Flexi<sup>®</sup> Vector can act as an acceptor of a protein-coding region flanked by SgfI and PmeI sites. The SgfI site is upstream of the start codon of the protein-coding region, and depending upon the Flexi<sup>®</sup> Vector used for cloning, this allows the expression of a native (untagged) protein or an amino- (N-) terminal-tagged protein by readthrough of the SgfI site (Figure 6, Section 9.A). The PmeI site contains the stop codon for the protein-coding region and appends a single valine residue to the carboxy (C)-terminus of the protein.

Protein-coding regions can be cloned into Flexi<sup>®</sup> Vectors containing SgfI and PmeI sites. Inserts can be easily transferred to other Flexi<sup>®</sup> Vectors following digestion with SgfI and PmeI, which maintains insert orientation and reading frame, eliminating the need to resequence the insert after each transfer (Figure 1). This approach allows easy adaptation to high-throughput formats through the use of automated liquid-handling systems or multichannel pipettors.

C-terminal Flexi<sup>®</sup> Vectors allow expression of C-terminal-tagged proteins. While these vectors can act as acceptors of a protein-coding region flanked by SgfI and PmeI sites, they lack a PmeI site and contain a different blunt-end site, EcoICRI (Figure 2). When the blunt PmeI and EcoICRI ends are joined, the stop codon is not recreated, allowing readthrough into the C-terminal peptide sequence. However, this joined sequence cannot be cut by either PmeI or EcoICRI, so the protein-coding region cannot be removed from the C-terminal Flexi<sup>®</sup> Vectors and transferred to other Flexi<sup>®</sup> Vectors. In other words, transfer into C-terminal Flexi<sup>®</sup> Vectors is not reversible (i.e., it is a one-way exchange).

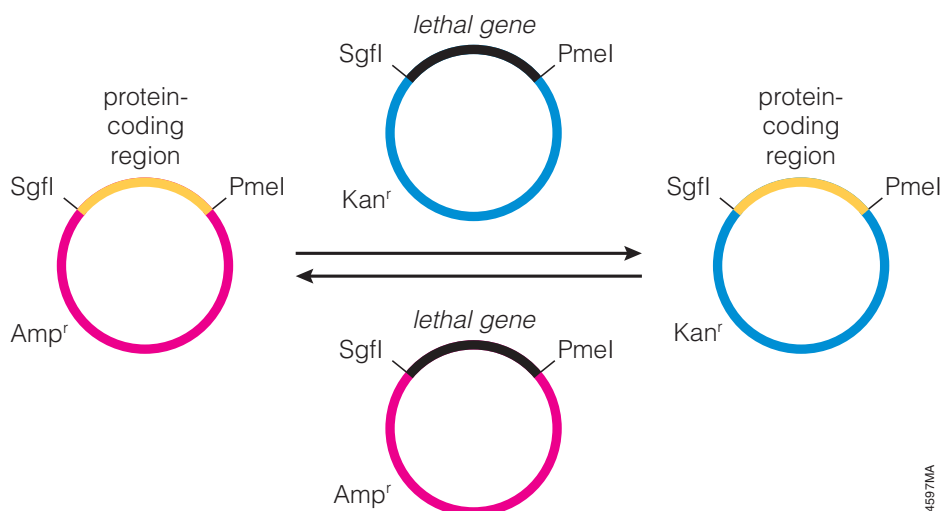

4597MA

**Figure 1. Transferring protein-coding regions in the Flexi® Vector Systems.** The Flexi® Vector Systems employ a flexible, directional cloning method to create plasmids to express protein-coding regions with or without peptide fusion tags. The features necessary for expression and the options for protein fusion tags are carried on the vector backbone, and the protein-coding region can be shuttled between vectors using two rare-cutting restriction endonucleases, Sgfl and PmeI. The Flexi® Vectors contain a lethal gene, barnase, for positive selection of the protein-coding sequence and an antibiotic resistance marker for selection of colonies containing the Flexi® Vector. Transfer between Flexi® Vectors for expression of native or N-terminal-tagged fusion proteins is reversible (i.e., it is a two-way exchange).

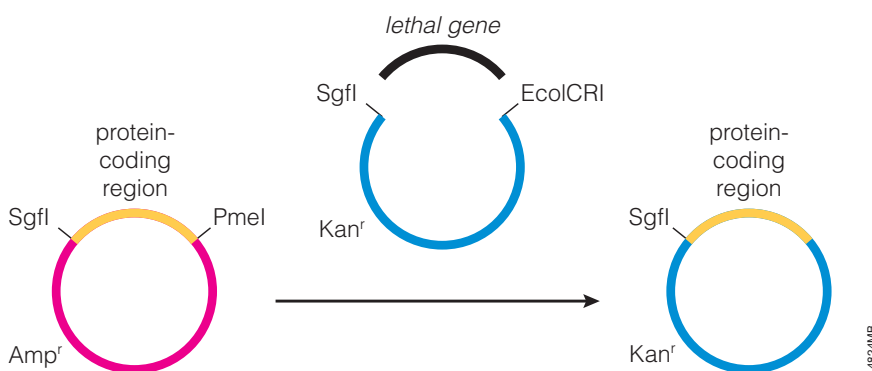

4824MB

**Figure 2. Transferring protein-coding regions into C-terminal Flexi® Vector Systems.** C-terminal Flexi® Vectors contain Sgfl and EcoICRI sites and are designed to allow expression of C-terminal-tagged proteins. Joining PmeI and EcoICRI blunt ends eliminates the stop codon present in the PmeI site and allows readthrough to the C-terminal protein-coding sequences in the C-terminal Flexi® Vectors. Since both restriction sites are destroyed by joining, transfer into C-terminal Flexi® Vectors is not reversible (i.e., it is a one-way exchange).



## 2. Product Components and Storage Conditions

Product	Size	Cat.#
Flexi® System, Entry/Transfer	5 entry and 20 transfer reactions	C8640

Each system contains sufficient reagents for 5 entry reactions into a Flexi® Vector and 20 transfer reactions to other Flexi® Vectors. This system does not include a DNA polymerase for amplification of the protein-coding region. The Flexi® System, Entry/Transfer, consists of 2 sets of reagents, Cat.# C8641 and A9280, each shipped separately. The Flexi® Vectors must be purchased separately. Includes:

### Cat.# C8641 Flexi® System, Entry/Transfer includes:

- 2 × 50µl Flexi® Enzyme Blend (SgfI & PmeI)
- 500u T4 DNA Ligase (HC)
- 1ml 5X Flexi® Digest Buffer
- 500µl 2X Flexi® Ligase Buffer
- 1.25ml Nuclease-Free Water

**Storage Conditions:** Store all components at -20°C. Do not freeze the Flexi® Enzyme Blend (SgfI & PmeI) at -70°C. Avoid multiple freeze-thaw cycles of the 2X Flexi® Ligase Buffer by making single-use aliquots of the buffer.

### Cat.# A9280 Wizard® SV Gel and PCR Clean-Up System includes:

- 10 Wizard® SV Minicolumns
- 10 Collection Tubes
- 5 Vacuum Adapters
- 3ml Membrane Wash Solution
- 4ml Membrane Binding Solution
- 1.25ml Nuclease-Free Water

**Storage Conditions:** Store all components at room temperature.

Product	Size	Cat.#
Flexi® System, Transfer	100 transfer reactions	C8820

Each system contains sufficient reagents for 100 transfer reactions from one Flexi® Vector to another. This system does not include a DNA polymerase for amplification of the protein-coding region. The Flexi® Vectors must be purchased separately. Includes:

- 4 × 50µl Flexi® Enzyme Blend (SgfI & PmeI)
- 4 × 500u T4 DNA Ligase (HC)
- 1ml 5X Flexi® Digest Buffer
- 2 × 500µl 2X Flexi® Ligase Buffer
- 2 × 1.25ml Nuclease-Free Water

**Storage Conditions:** Store all components at -20°C. Do not freeze the Flexi® Enzyme Blend (SgfI & PmeI) at -70°C. Avoid multiple freeze-thaw cycles of the 2X Flexi® Ligase Buffer by making single-use aliquots of the buffer.

Product	Size	Cat.#
Carboxy Flexi® System, Transfer	50 transfer reactions	C9320

Each system contains sufficient reagents for 50 reactions. This system does not include a DNA polymerase for amplification of the protein-coding region. The Flexi® Vectors must be purchased separately. Includes:

- 50µl Carboxy Flexi® Enzyme Blend (Sgfl & EcoICRI)
- 50µl Flexi® Enzyme Blend (Sgfl & PmeI)
- 2 × 500u T4 DNA Ligase (HC)
- 1ml 5X Flexi® Digest Buffer
- 500µl 2X Flexi® Ligase Buffer
- 1.25ml Nuclease-Free Water

**Storage Conditions:** Store all components at  $-20^{\circ}\text{C}$ . Do not freeze the Carboxy Flexi® Enzyme Blend (Sgfl & EcoICRI) or Flexi® Enzyme Blend (Sgfl & PmeI) at  $-70^{\circ}\text{C}$ . Avoid multiple freeze-thaw cycles of the 2X Flexi® Ligase Buffer by making single-use aliquots of the buffer.

### 3. General Considerations

The Flexi® Vector Systems use two rare-cutting restriction endonucleases: Sgfl and PmeI. Sgfl has the fewest restriction sites in the protein-coding regions of human cDNA sequences, and PmeI has the next fewest. This enzyme pair also cuts infrequently in the open reading frames of many organisms (Table 2). Most (>98%) known human open reading frames are not affected by the use of these restriction enzymes for directional cloning. However, we recommend scanning your protein-coding region for Sgfl and PmeI sites. The presence of Sgfl or PmeI sites within the protein-coding region will interfere with the cloning of the full-length protein-coding region. If your protein-coding region contains these sites, consider cloning a portion of the protein-coding region or using RecA protein to protect the Sgfl or PmeI sites within the protein-coding region from digestion (1). Alternatively, PCR-based, site-directed mutagenesis methods (2,3) can be used to mutate restriction enzyme sites without changing the amino acid sequence of a protein-coding region.

**Note:** Promega provides a tool that scans your sequence for Sgfl and PmeI sites to ensure these sites are absent and that helps with primer design. This tool is available at: [promega.com/techserv/tools/flexivector/](http://promega.com/techserv/tools/flexivector/)

The desired protein-coding region must be amplified by PCR before being cloned into the Flexi® Vectors (Figure 3). The optimal conditions for amplifying the protein-coding region will depend on the DNA template, DNA polymerase, PCR primers and other reaction parameters. We recommend following the protocol provided with the DNA polymerase to be used to generate the PCR product. For protein-coding regions less than 700bp, consider using *Taq* DNA polymerase to amplify your protein-coding region. For regions greater than 700bp, we

### 3. General Considerations (continued)

recommend the use of a high-fidelity DNA polymerase, such as *Pfu* DNA polymerase. To facilitate cloning, the PCR primers used to amplify the protein-coding region must append an SgfI site and a PmeI site to the PCR product. To append these sites, incorporate an SgfI site in your amino-terminal PCR primer and a PmeI site in your carboxy-terminal PCR primer. Transfer of protein-coding regions into N-terminal fusion vectors results in translational readthrough of the SgfI site, which encodes the peptide sequence Ala-Ile-Ala. The PmeI site is placed at the carboxy terminus, appending a single valine residue to the last amino acid of the protein-coding region. The valine codon, GTT, is immediately followed by an ochre stop codon, TAA. Primer design guidelines are provided in Section 9.C and at: [promega.com/techserv/tools/flexivector/](http://promega.com/techserv/tools/flexivector/)

C-terminal protein fusions are created by inserting the SgfI/PmeI fragment containing the protein-coding region into a C-terminal Flexi<sup>®</sup> Vector cut with SgfI and EcoICRI. The blunt end of PmeI (GTTT) is ligated to the blunt end of EcoICRI (CTC) to generate the sequence: GTT TCT CNN. This sequence translates to Val-Ser-Xaa, allowing readthrough into the C-terminal sequences present on the C-terminal Flexi<sup>®</sup> Vectors. Since both the PmeI and EcoICRI sites are destroyed, the protein-coding region cannot be transferred from these vectors. For this reason, it is inadvisable to clone a protein-coding PCR fragment directly into a C-terminal Flexi<sup>®</sup> Vector if you plan to transfer the protein-coding region to a different Flexi<sup>®</sup> Vector in the future. By cloning the PCR fragment first into a native or N-terminal Flexi<sup>®</sup> Vector, the ability to transfer to any other Flexi<sup>®</sup> Vector is preserved.

**Table 1. Frequency of cDNAs or Open Reading Frames (ORFs) Lacking SgfI or PmeI Sites.**

Dataset <sup>1</sup>	ORFs Examined	Entries Lacking SgfI Site(s)	Entries Lacking PmeI Site(s)	Entries Lacking SgfI or PmeI Site(s)
Human ( <i>H. sapiens</i> )	27,974	99.58%	99.30%	98.88%
Mouse ( <i>M. musculus</i> )	26,538	99.68%	99.19%	98.87%
Rat ( <i>R. norvegicus</i> )	22,845	99.65%	99.19%	98.85%
<i>D. melanogaster</i>	18,748	94.97%	99.29%	94.34%
<i>E. coli</i> (K12)	4,255	95.18%	98.33%	93.65%
<i>C. elegans</i>	21,124	99.19%	99.25%	98.46%
<i>S. cerevisiae</i>	5,869	99.54%	97.48%	97.04%
<i>A. thaliana</i>	28,951	99.36%	98.24%	97.61%

<sup>1</sup>Data for this analysis was obtained from RefSeq Release 6. This full release incorporates genomic, transcript and protein data available as of July 5, 2004, and includes 1,050,975 proteins and sequences from 2,467 different organisms. The current RefSeq release is available at: <ftp://ftp.ncbi.nih.gov/refseq/release/>

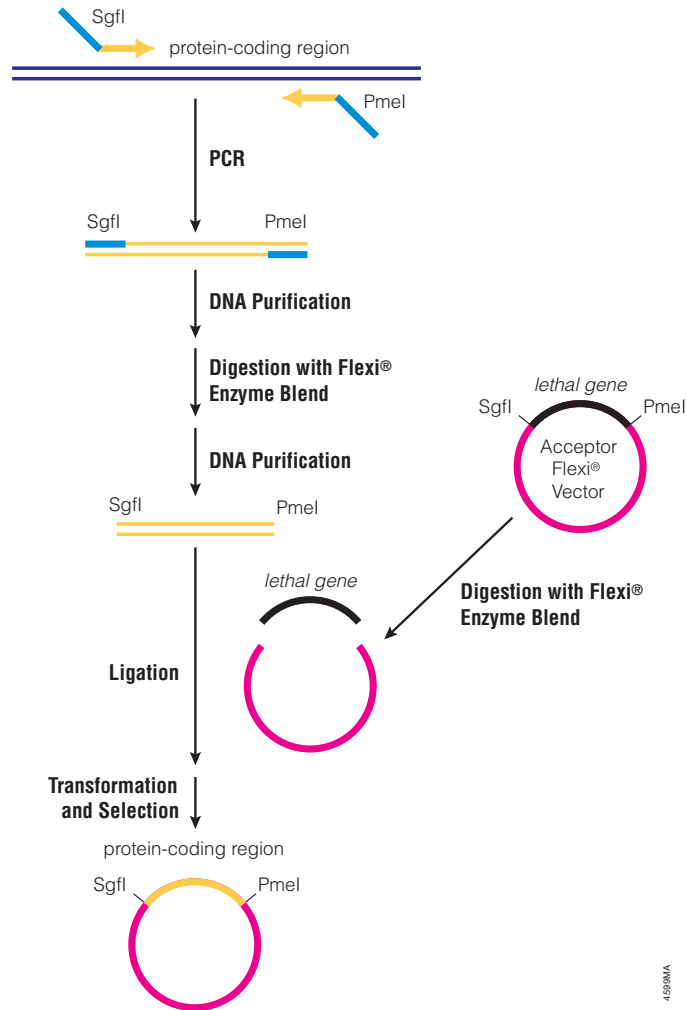

**Figure 3. Cloning a protein-coding region into the Flexi® Vectors.** PCR primers are designed to append SgfI and PmeI sites to the protein-coding region. After amplification, the PCR product is purified to remove the DNA polymerase and primers and digested with SgfI and PmeI. The DNA is purified again to remove the small oligonucleotides released by the restriction enzymes. The digested PCR product is ligated into an acceptor Flexi® Vector that has been digested with SgfI and PmeI. Following transformation, the cells are selected with the appropriate antibiotic for the particular Flexi® Vector used.



#### 4. Cloning PCR Products into the Flexi® Vectors (Entry Reaction)

The desired protein-coding region must first be amplified by PCR before being cloned into the Flexi® Vectors (see Section 3 and Figure 3). This protocol describes direct purification of DNA from the amplification reaction. If the amplification yields multiple PCR products, purify the desired band from an agarose gel to remove undesired PCR products; a protocol is provided in Section 9.E. To reduce primer dimer carryover, 80% ethanol can be substituted for the prepared Membrane Wash Solution used to wash the SV Minicolumn in Step 6.

##### Materials to Be Supplied by the User

(Solution compositions are provided in Section 8.)

- 95% ethanol
- high-efficiency competent cells ( $\geq 1 \times 10^8$ cfu/ $\mu$ g)
- 1.5ml polypropylene microcentrifuge tubes or 17  $\times$  100mm polypropylene tubes (Falcon®, BD Cat.# 2059)
- LB plates with the appropriate antibiotic at the appropriate concentration (Section 9.G)
- SOC medium

##### 4.A. Purification of PCR Products

1. Add 15ml of 95% ethanol to the Membrane Wash Solution. Mark the bottle label to record that this addition was made. Tightly close the bottle cap after each use to prevent evaporation.
2. Add an equal volume of Membrane Binding Solution to the amplification reaction (see Notes 1 and 2).

At this point, the DNA can be purified using microcentrifugation to force the solution through the Wizard® SV Minicolumn and to wash the DNA (proceed to Step 3). Alternatively, a vacuum can be used to pull the solution through the Minicolumn and to wash the DNA (proceed to the vacuum protocol in Section 9.F). Vacuum Adapters allow the use of a vacuum manifold (e.g., a Vac-Man® Laboratory Vacuum Manifold, Cat.# A7231) and vacuum source for DNA purification.

3. For each amplification reaction, place one SV Minicolumn in a Collection Tube.
4. Transfer the amplification reaction to the SV Minicolumn assembly and incubate for 1 minute at room temperature.
5. Centrifuge the SV Minicolumn assembly in a microcentrifuge at 16,000  $\times$  g for 1 minute. Remove the SV Minicolumn from the SV Minicolumn assembly and discard the liquid in the Collection Tube. Return the SV Minicolumn to the Collection Tube.

6. Wash the column by adding 700 $\mu$ l of Membrane Wash Solution to the SV Minicolumn. Centrifuge the SV Minicolumn assembly for 1 minute at 16,000  $\times$  g. Empty the Collection Tube as before and place the SV Minicolumn back in the Collection Tube. Repeat the wash with 500 $\mu$ l of Membrane Wash Solution, and centrifuge the SV Minicolumn assembly for 5 minutes at 16,000  $\times$  g.
7. Remove the SV Minicolumn assembly from the centrifuge, being careful not to wet the bottom of the column with the flowthrough. Empty the Collection Tube, return the SV Minicolumn to the Collection Tube and centrifuge the column assembly for 1 minute with the microcentrifuge lid open (or off) to allow evaporation of residual ethanol.
8. Carefully transfer the SV Minicolumn to a clean 1.5ml microcentrifuge tube. Apply 50 $\mu$ l of Nuclease-Free Water directly to the center of the column without touching the membrane with the pipette tip. Incubate at room temperature for 1 minute. Centrifuge for 1 minute at 16,000  $\times$  g (see Note 3).
9. Discard the SV Minicolumn and store the microcentrifuge tube containing the eluted DNA on ice while assembling the restriction enzyme digests in Section 4.B.

**Notes:**

1. The maximum binding capacity of the column is approximately 40 $\mu$ g of DNA per column, and as little as 10ng has been successfully purified. The maximal capacity of a single SV Minicolumn is approximately 1ml of PCR product added to 1ml Membrane Binding Solution (2ml total). For PCR volumes >350 $\mu$ l, continue to pass the sample through the column until all of the sample has been processed.
2. Mineral oil does not interfere with purification.
3. The volume of eluted DNA will be approximately 42–47 $\mu$ l. If the DNA needs to be further concentrated, perform an ethanol precipitation. Alternatively, the DNA may be eluted in as little as 15 $\mu$ l of Nuclease-Free Water without a significant reduction in yield. If using an elution volume of 15 $\mu$ l, verify that the membrane is completely covered with Nuclease-Free Water before centrifugation. Do not elute in volumes less than 15 $\mu$ l (see Section 9.H).

#### 4.B. Restriction Digest of PCR Product and Acceptor Flexi® Vector

Digestion reactions for the PCR product and the acceptor Flexi® Vector can be performed concurrently.

 Do not use C-terminal Flexi® Vectors, which have names starting with "pFC", as acceptors for PCR products if you plan to transfer the protein-coding region to a different Flexi® Vector in the future. C-terminal Flexi® Vectors lack PmeI sites and cannot serve as donors for other Flexi® Vectors.

1. Thaw the 5X Flexi® Digest Buffer, the acceptor Flexi® Vector and Nuclease-Free Water, and store on ice. Vortex the 5X Flexi® Digest Buffer and the acceptor Flexi® Vector before use.
2. Assemble the following reaction components to cut the PCR product with SgfI and PmeI.

Component	Volume
5X Flexi® Digest Buffer	4µl
Purified PCR product (up to 500ng)	– µl
Flexi® Enzyme Blend (SgfI & PmeI)	4µl
Nuclease-Free Water to a final volume of	20µl

Assemble the following reaction components to cut the acceptor Flexi® Vector with SgfI and PmeI.

Component	Volume
Nuclease-Free Water	12µl
5X Flexi® Digest Buffer	4µl
Acceptor Flexi® Vector (200ng)	2µl
Flexi® Enzyme Blend (SgfI & PmeI)	2µl
Final Volume	20µl

 Take care when pipetting solutions that contain glycerol, such as the Flexi® Enzyme Blend, because small volumes are difficult to pipet accurately.

3. Incubate both reactions at 37°C for 30 minutes.
4. Heat the reaction with the Flexi® Vector at 65°C for 20 minutes to inactivate the restriction enzymes. Store on ice until the PCR product and vector are ligated in Section 4.D.
5. Add 20µl of Membrane Binding Solution to the reaction with the PCR product. Do not add Membrane Binding Solution to the reaction with the acceptor Flexi® Vector.

#### 4.C. Cleanup of PCR Products

DNA can be purified using microcentrifugation to force the solution through the SV Minicolumn and wash the DNA. Alternatively, a vacuum can be used to pull the solution through the Minicolumn and wash the DNA. The Vacuum Adapters allow the use of a vacuum manifold (e.g., a Vac-Man® Laboratory Vacuum Manifold) and vacuum source for DNA purification. To purify the DNA using a vacuum manifold, proceed to the vacuum protocol in Section 9.F.

1. For each amplification reaction, place one SV Minicolumn in a Collection Tube.
2. Transfer the PCR product prepared in Section 4.B, Step 5, to the SV Minicolumn assembly, and incubate for 1 minute at room temperature.
3. Centrifuge the SV Minicolumn assembly in a microcentrifuge at  $16,000 \times g$  (14,000 rpm) for 1 minute. Remove the SV Minicolumn from the SV Minicolumn assembly, and discard the liquid in the Collection Tube. Return the SV Minicolumn to the Collection Tube.
4. Wash the column by adding 700 $\mu$ l of Membrane Wash Solution, previously diluted with 95% ethanol (see Section 4.A, Step 1), to the SV Minicolumn. Centrifuge the SV Minicolumn assembly for 1 minute at  $16,000 \times g$ . Empty the Collection Tube, and place the SV Minicolumn back in the Collection Tube. Repeat the wash with 500 $\mu$ l of prepared Membrane Wash Solution, and centrifuge the SV Minicolumn assembly for 5 minutes at  $16,000 \times g$ .
5. Remove the SV Minicolumn assembly from the centrifuge, being careful not to wet the bottom of the column with the flowthrough. Empty the Collection Tube, return the SV Minicolumn to the Collection Tube, and centrifuge the column assembly for 1 minute with the microcentrifuge lid open (or off) to allow evaporation of residual ethanol.
6. Carefully transfer the SV Minicolumn to a clean 1.5ml microcentrifuge tube. Apply 30 $\mu$ l of Nuclease-Free Water directly to the center of the column without touching the membrane with the pipette tip. Incubate at room temperature for 1 minute. Centrifuge for 1 minute at  $16,000 \times g$ .
7. Discard the SV Minicolumn, and store the microcentrifuge tube containing the eluted DNA on ice while assembling the ligation reaction in Section 4.D.

**Note:** Alternatively, the DNA can be stored at  $-20^{\circ}\text{C}$  if you are not proceeding directly to the ligation reaction in Section 4.D.

#### 4.D. Ligation of PCR Product and Acceptor Flexi® Vector

1. Assemble the following reaction components:

Component	Volume
2X Flexi® Ligase Buffer	10µl
Acceptor Flexi® Vector from Section 4.B, Step 4 (50ng)	5µl
PCR product (approximately 100ng)	–µl
T4 DNA Ligase (HC) (20u/µl)	1µl
Nuclease-Free Water to a final volume of	<b>20µl</b>

2. Incubate at room temperature for 1 hour.



The 2X Flexi® Ligase Buffer contains ATP, which degrades during temperature fluctuations. Avoid multiple freeze-thaw cycles and exposure to frequent temperature changes by making single-use aliquots of the buffer.

#### 4.E. Transformation

Transform the ligation reaction into high-efficiency, *E. coli* competent cells ( $\geq 1 \times 10^8$ cfu/µg DNA). If you are using competent cells other than high-efficiency JM109 Competent Cells (Cat.# L2001) purchased from Promega, it is important to follow the appropriate transformation protocol. The recommended transformation protocol for Promega high-efficiency JM109 Competent Cells is provided in Section 9.G. Selection for transformants should be done on LB plates supplemented with 100µg/ml ampicillin or 25µg/ml kanamycin, as appropriate for the acceptor Flexi® Vector.

**Note:** Use 100µg/ml ampicillin or 25µg/ml kanamycin to select clones. Flexi® Vectors with the letter “A” in the name contain the ampicillin resistance gene, and Flexi® Vectors with the letter “K” in the name contain the kanamycin resistance gene.

#### 4.F. Screening for the Desired Clone

Screen 8–12 colonies for each PCR product. Digest the plasmid to ensure that both SgfI and PmeI cleave their recognition sites flanking the protein-coding region, so the insert can be cloned into other Flexi® Vectors. The Flexi® Vector Systems contain sufficient volume of the 10X Flexi® Enzyme Blend (SgfI & PmeI) to perform the cloning steps only. The 10X Flexi® Enzyme Blend (SgfI & PmeI) can be purchased separately for screening purposes. The protocol for digestion of plasmid DNA with the 10X Flexi® Enzyme Blend (SgfI & PmeI) can be found in Section 9.D.

Since PCR was used to create the original insert, we recommend verifying the sequence of the protein-coding region in the initial clone by DNA sequencing. Depending on the error rate of the DNA polymerase used in PCR, you may need to screen multiple colonies to find a clone with the correct protein-coding sequence.

**Note:** The 10X Flexi® Enzyme Blend (SgfI & PmeI) (Cat.# R1851 or R1852) is available separately for screening clones.

## 5. Transfer of Protein-Coding Regions Between Flexi® Vectors

To transfer your protein-coding region from one Flexi® Vector (donor) to another Flexi® Vector (acceptor), choose the appropriate acceptor vector with the desired expression and tag options (Table 1). Choose an acceptor Flexi® Vector with a different antibiotic resistance marker than the donor because antibiotic selection is the basis for selecting the desired clone.

There are two basic categories of Flexi® Vectors: those containing SgfI and PmeI sites and expressing either a native (untagged) protein or an N-terminal-tagged protein, and those containing SgfI and EcoICRI sites and expressing a C-terminal-tagged protein. Flexi® Vectors for expressing C-terminal-tagged proteins act only as acceptors, never as donor vectors. To transfer protein-coding regions between Flexi® Vectors expressing native protein or an N-terminal-tagged protein, the donor and acceptor vectors are digested with SgfI and PmeI simultaneously, prior to ligation of the insert, transformation and selection of the cells (Figure 4 and Section 5.A). To create a C-terminal-tagged protein, the donor plasmid expressing native protein or an N-terminal-tagged protein is digested with SgfI and PmeI. Because EcoICRI cuts frequently in protein-coding regions, the acceptor plasmid containing the C-terminal tag is digested with SgfI and EcoICRI in a separate reaction. The two separate digests are combined for ligation of the insert, transformation and selection of the cells (Figure 5 and Section 5.B).

### 5.A. Transfer of Protein-Coding Regions Between Flexi® Vectors Expressing Native or N-Terminal Fusion Proteins

 Do not use C-terminal Flexi® Vectors, which have names starting with “pFC”, as acceptors or donors since they lack PmeI sites.

1. Use the Wizard® *Plus* SV Minipreps DNA Purification System (Cat.# A1330), Wizard® SV 96 Plasmid DNA Purification System (Cat.# A2250) or a similar method to prepare the donor Flexi® Vector DNA. Adjust the volume, so the final DNA concentration is 50–100ng/μl.
2. Assemble the following reaction components to cut the Flexi® Vectors:

Component	Volume
5X Flexi® Digest Buffer	4μl
Acceptor Flexi® Vector (100ng)	1μl
Donor Flexi® Vector (100ng)	– μl
Flexi® Enzyme Blend (SgfI & PmeI)	2μl
Nuclease-Free Water to a final volume of	20μl

 Take care when pipetting solutions that contain glycerol, such as the Flexi® Enzyme Blend, because small volumes are difficult to pipet accurately.

3. Incubate at 37°C for 15–30 minutes.
4. Heat the reaction at 65°C for 20 minutes to inactivate the restriction enzymes. Store the reaction on ice while assembling the ligation reaction in Step 5.

**5.A. Transfer of Protein-Coding Regions Between Flexi® Vectors Expressing Native or N-Terminal Fusion Proteins (continued)**

5. Assemble the following ligation reaction components:

Component	Volume
2X Flexi® Ligase Buffer	10µl
Digested DNA from Step 4 (100ng total)	10µl
T4 DNA Ligase (HC) (20u/µl)	1µl
Nuclease-Free Water to a final volume of	<b>21µl</b>

6. Incubate at room temperature for 1 hour.
7. Transform the ligation reaction into high-efficiency, *E. coli* competent cells ( $\geq 1 \times 10^8$ cfu/µg DNA). If you are using competent cells other than high-efficiency JM109 Competent Cells (Cat.# L2001) purchased from Promega, it is important to follow the appropriate transformation protocol. The recommended transformation protocol for Promega high-efficiency JM109 Competent Cells is provided in Section 9.G. Selection for transformants should be on LB plates supplemented with 100µg/ml ampicillin or 25µg/ml kanamycin, as appropriate for the acceptor Flexi® Vector. See Table 1 for a list of antibiotic resistance genes carried on the various vectors.

**Note:** Use 100µg/ml ampicillin or 25µg/ml kanamycin to select clones. Flexi® Vectors with the letter “A” in the name contain the ampicillin resistance gene, and Flexi® Vectors with the letter “K” in the name contain the kanamycin resistance gene.

8. Screen at least 4 colonies for each protein-coding region. Digest the plasmid to ensure that SgfI and PmeI cleave their recognition sites flanking the protein-coding region, so the insert can be cloned into other Flexi® Vectors.

Screen at least 8 colonies for each protein-coding region transferred to or from the pF3A WG (BYDV) or pF3K WG (BYDV) Flexi® Vectors. Lower transfer frequencies with these vectors are due to a higher background of plasmid backbone heterodimers between the WG (BYDV) Vectors and other Flexi® Vectors. Other Flexi® Vectors share common regions flanking the SgfI and PmeI sites, such that plasmid backbone dimers are unstable (4). The pF3A and pF3K WG (BYDV) Flexi® Vectors lack these common flanking regions because of the inclusion of the BYDV translation-enhancing sequences.

If you are using the pF3A WG (BYDV) or pF3K WG (BYDV) Flexi® Vectors, the number of minipreps performed can be reduced by prescreening colonies to identify those harboring plasmid backbone heterodimers. Colonies containing such heterodimers can be identified by their ability to grow in the presence of both antibiotics. Pick individual colonies and restreak on a plate containing ampicillin and a plate containing kanamycin, or inoculate two broth cultures for overnight growth, one with ampicillin and the other with kanamycin. Colonies containing the clone of interest will grow only in the medium containing the antibiotic associated with the acceptor plasmid.

## 5.B. Transfer Protocol from Native or N-Terminal Flexi® Vectors to C-Terminal Flexi® Vectors

Use the C-terminal Flexi® Vectors, which have names starting with “pFC”, as acceptors but not as donors since they lack PmeI sites.

1. Use the Wizard® *Plus* SV Minipreps DNA Purification System (Cat.# A1330), Wizard® SV 96 Plasmid DNA Purification System (Cat.# A2250) or a similar method to prepare the donor Flexi® Vector DNA. Adjust the volume, so the final DNA concentration is 50–100ng/μl.
2. Assemble the following reaction components to cut the donor Flexi® Vector:

Component	Volume
5X Flexi® Digest Buffer	2μl
Donor Flexi® Vector (100ng)	__μl
Flexi® Enzyme Blend (SgfI & PmeI)	1μl
Nuclease-Free Water to a final volume of	10μl

Take care when pipetting solutions that contain glycerol, such as the Flexi® Enzyme Blend, because small volumes are difficult to pipet accurately.

3. In a separate tube, assemble the following reaction components to cut the acceptor C-terminal Flexi® Vector:

Component	Volume
Nuclease-Free Water	6μl
5X Flexi® Digest Buffer	2μl
Acceptor C-terminal Flexi® Vector DNA (100ng)	1μl
Carboxy Flexi® Enzyme Blend (SgfI & EcoICRI)	1μl
Final volume	10μl

**Note:** Acceptor C-terminal Flexi® Vectors will have names starting with “pFC”.

4. Incubate both reactions at 37°C for 15–30 minutes.
5. Heat both reactions at 65°C for 20 minutes to inactivate the restriction enzymes. Store the reactions on ice while assembling the ligation reaction in Step 6.
6. Assemble the following ligation reaction components:

Component	Volume
2X Flexi® Ligase Buffer	10μl
Digested donor Flexi® Vector prepared in Step 2 (approximately 50ng)	5μl
Digested acceptor C-terminal Flexi® Vector prepared in Step 3 (50ng)	5μl
T4 DNA Ligase (HC) (20u/μl)	1μl
Final volume	21μl



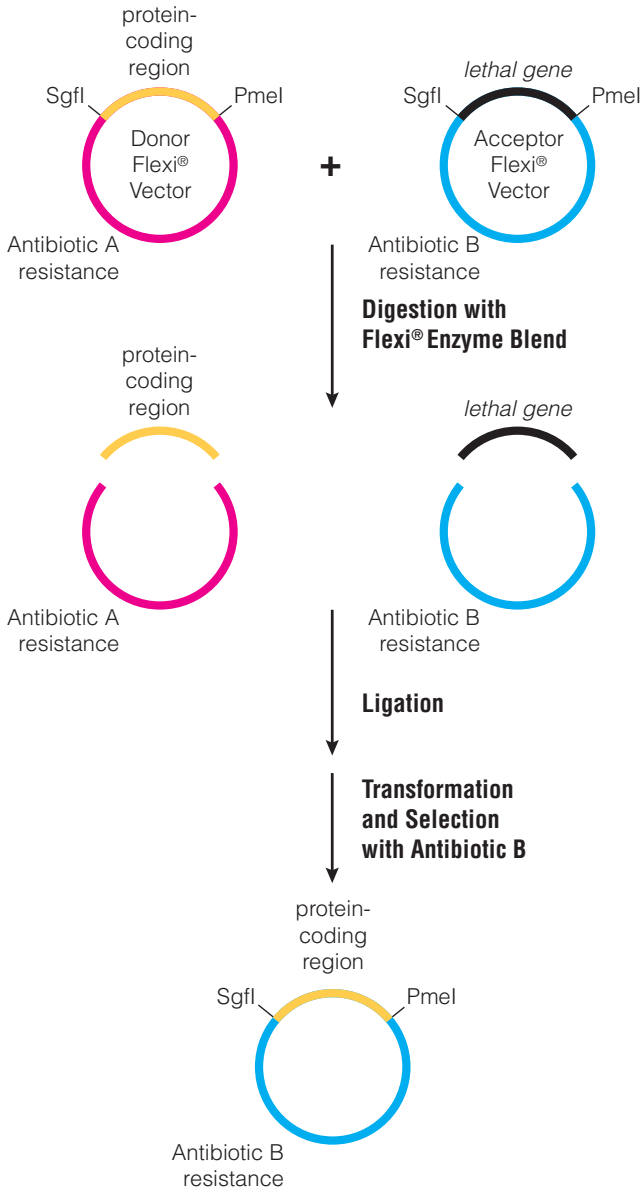

**Figure 4. Transfer of a protein-coding region between N-terminal or native Flexi<sup>®</sup> Vectors.** The donor Flexi<sup>®</sup> Vector containing the protein-coding region is mixed with an acceptor Flexi<sup>®</sup> Vector that has a different antibiotic resistance. The two plasmids are digested with SgfI and PmeI, and the mixture is ligated and transformed into *E. coli*. The cells are plated on the appropriate selective media for the acceptor Flexi<sup>®</sup> Vector. Protein-coding regions transferred into N-terminal fusion vectors allow translational readthrough of the SgfI site, which encodes the peptide sequence Ala-Ile-Ala.

46000MA

7. Incubate at room temperature for 1 hour.
8. Transform the ligation reaction into high-efficiency *E. coli* competent cells ( $1 \times 10^8$ cfu/ $\mu$ g DNA). If you are using competent cells other than high-efficiency JM109 Competent Cells (Cat.# L2001) purchased from Promega, it is important to follow the appropriate transformation protocol. The recommended transformation protocol for Promega high-efficiency JM109 Competent Cells is provided in Section 9.G. Selection for transformants should be on LB plates supplemented with 100 $\mu$ g/ml ampicillin or 25 $\mu$ g/ml kanamycin, as appropriate for the acceptor Flexi<sup>®</sup> Vector. See Section 9.B for a list of antibiotic resistance genes carried on the various vectors.

**Note:** Use 100 $\mu$ g/ml ampicillin or 25 $\mu$ g/ml kanamycin to select clones. Flexi<sup>®</sup> Vectors with the letter A in the name contain the ampicillin resistance gene, and Flexi<sup>®</sup> Vectors with the letter K in the name contain the kanamycin resistance gene.

9. Screen at least 8 colonies for each protein-coding region. Successful plasmid constructs will not cut with PmeI but will cut with SgfI. Lower transfer frequencies are due to a relatively higher background of plasmid backbone heterodimers between the C-terminal Flexi<sup>®</sup> Vectors and other Flexi<sup>®</sup> Vectors. Other Flexi<sup>®</sup> Vectors share common regions flanking the SgfI and PmeI sites, such that plasmid backbone dimers are unstable (4). The C-terminal Flexi<sup>®</sup> Vectors may lack these common flanking regions because of the inclusion of the protein fusion tag sequence.

The number of minipreps performed can be reduced by prescreening colonies to identify those harboring plasmid backbone heterodimers. Colonies containing such heterodimers can be identified by their ability to grow on both antibiotics. Pick individual colonies and restreak on an ampicillin plate and a kanamycin plate, or inoculate two cultures for overnight growth in media: one with ampicillin and the other with kanamycin. Colonies containing the clone of interest will grow only in the antibiotic associated with the acceptor plasmid.

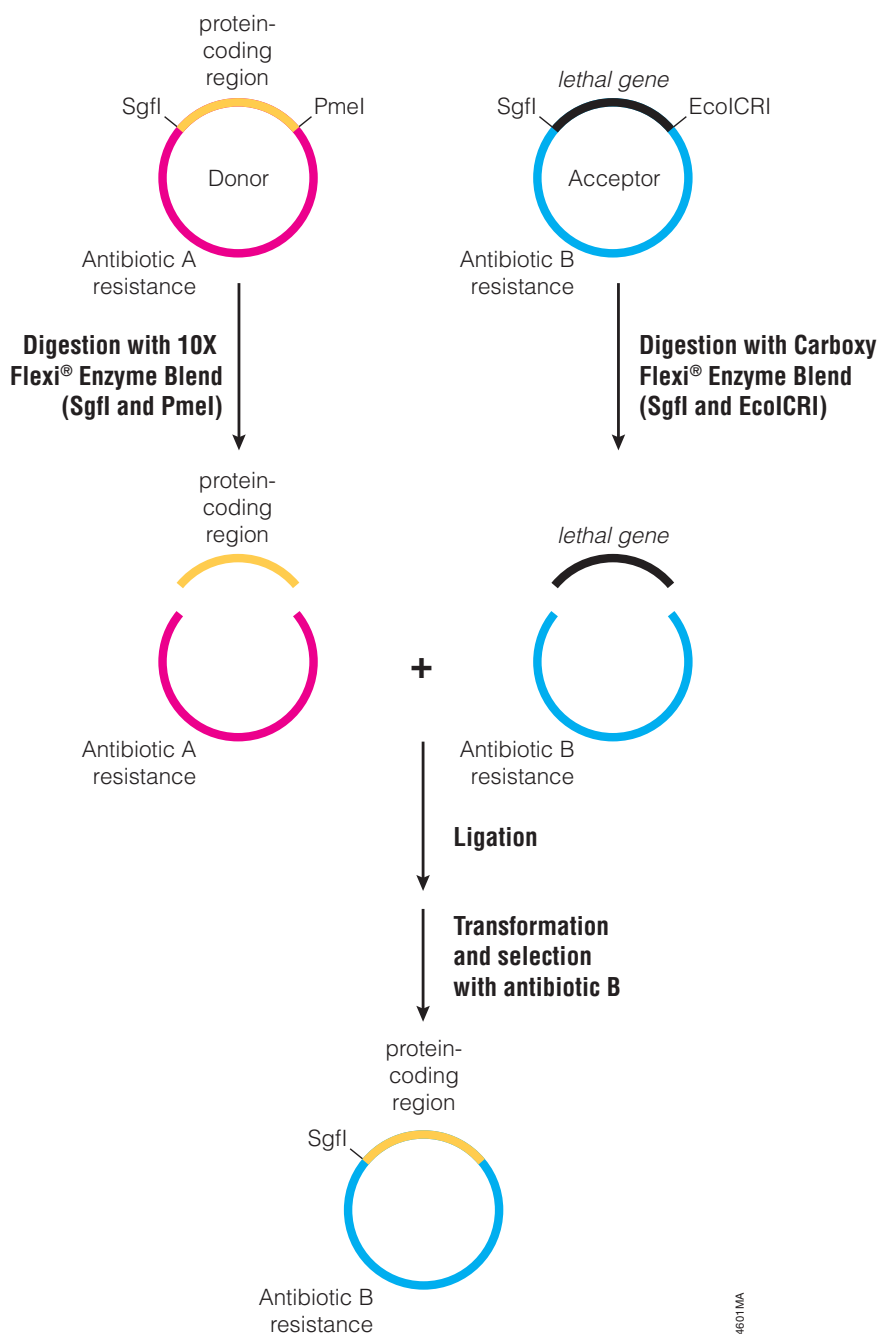

**Figure 5. Transfer of a protein-coding region into the C-terminal Flexi® Vectors.**

The donor Flexi® Vector containing the protein-coding region is digested with SgfI and PmeI. The acceptor Flexi® Vector, which has a different antibiotic resistance, is digested with SgfI and EcoICRI in a separate reaction. The two digested plasmids are combined, the mixture is ligated and transformed into *E. coli*, and cells are plated on the appropriate selective media for the acceptor Flexi® Vector. When the blunt ends of PmeI and EcoICRI are joined, an in-frame Ser codon, which appends the downstream C-terminal protein-coding region contained on the Flexi® Vector backbone, is created.

## 6. Troubleshooting

For questions not addressed here, please contact your local Promega Branch Office or Distributor. Contact information available at: [www.promega.com](http://www.promega.com). E-mail: [techserv@promega.com](mailto:techserv@promega.com)

Symptoms	Causes and Comments
No colonies or low numbers of colonies	<p>Poor transformation efficiency. Use high-efficiency competent cells (<math>\geq 1 \times 10^8</math> cfu/<math>\mu</math>g DNA). Test efficiency by transforming the cells with an uncut plasmid that allows antibiotic selection, such as the pGEM<sup>®</sup>-5Zf(+) Vector (Cat.# P2241). The intact Flexi<sup>®</sup> Vectors contain a lethal gene and are not appropriate as a transformation control.</p>
	<p>Restriction digest failed. Check the activity of the Flexi<sup>®</sup> Enzyme Blend (SgfI &amp; PmeI) by digesting 100ng of the acceptor Flexi<sup>®</sup> Vector with 1<math>\mu</math>l of Flexi<sup>®</sup> Enzyme Blend in a final volume of 10<math>\mu</math>l at 37°C for 1 hour. Analyze the results on an agarose gel. After a 1-hour digestion, the vector should be cut to at least 95% completion.</p>
	<p>Ligation reaction failed. The 2X Flexi<sup>®</sup> Ligase Buffer contains ATP, which degrades during temperature fluctuations. Avoid multiple freeze-thaw cycles by making single-use aliquots of the buffer. Use a fresh vial of the buffer.</p>
	<p>To test the activity of T4 DNA ligase and 2X Flexi<sup>®</sup> Ligase Buffer, assemble a ligation with 20ng of DNA Markers (e.g., Lambda DNA/HindIII Markers, Cat.# G1711). Compare ligated and nonligated DNA on an agarose gel to determine if the fragments were ligated into higher molecular weight DNA fragments.</p>
	<p>Ligation temperature too high or incubation time too short. The ligation temperature should be approximately 20°C and should not exceed 28°C. Sufficient ligation should occur in 60 minutes.</p>
	<p>Inhibitors of T4 DNA ligase or restriction enzymes in the PCR product or donor Flexi<sup>®</sup> Vector preparation. Clean up DNA preparations to eliminate potential contaminants, such as guanidinium or ethanol.</p>
	<p>C-terminal Flexi<sup>®</sup> Vector was cut with the wrong enzyme blend. Be sure to cut C-terminal Flexi<sup>®</sup> Vectors with the Carboxy Flexi<sup>®</sup> Enzyme Blend (SgfI &amp; EcoICRI), not the Flexi<sup>®</sup> Enzyme Blend (SgfI &amp; PmeI) (Section 5.B).</p>



## 6. Troubleshooting (continued)

### Symptoms

High colony number but low percentage containing protein-coding region

### Causes and Comments

Inactive antibiotic, allowing antibiotic-sensitive cells to grow. Streak an antibiotic-sensitive clone on plates with and without antibiotic to test the activity of the antibiotic. Growth of sensitive cells in the presence of antibiotic indicates inactive antibiotic.

Possible nuclease contaminants in the PCR product or donor Flexi® Vector preparation. Nucleases can remove the single-stranded SgfI overhang to create a blunt end. The vector can then religate without the barnase gene, and colonies containing religated vector can appear. Minimize the volume of potentially contaminated PCR product or donor Flexi® Vector preparations. Decrease the incubation time for the restriction digestion.

Contaminating primer dimers or PCR primers competing for restriction enzyme digestion and ligation into the acceptor vector. Use the procedure described in Section 4 or the Wizard® SV Gel and PCR Clean-Up System (Cat.# A9281) to purify PCR products before restriction enzyme digestion and cleaved PCR products before ligation.

Pyrimidine dimers formed by overexposure of DNA to ultraviolet (UV) light interfering with ligation. Minimize exposure of DNA to short-wave UV light. If possible, visualize the PCR product using a long-wave UV source. Place a glass plate between the gel and UV source to decrease exposure.

Multiple amplification products cloned into the Flexi® Vector. Gel-purify the PCR product of interest to remove any nonspecific amplification products and primer dimer.

Optimize amplification conditions to minimize production of undesired PCR products.

Redesign the PCR primers.

Donor Flexi® Vector with the protein-coding region was cut with the wrong enzyme blend. Be sure to cut with the Flexi® Enzyme Blend (SgfI & PmeI), not the Flexi® Enzyme Blend (SgfI & EcoICRI) for the transfer reaction (Section 5.B).

## 7. References

1. Schoenfeld, T., Harper, T. and Slater, M. (1995) RecA cleavage and protection for genomic mapping and subcloning. *Promega Notes* **50**, 9-13.
2. Higuchi, R., Krummel, B. and Saiki, R.K. (1988) A general method of in vitro preparation and specific mutagenesis of DNA fragments: Study of protein and DNA interactions. *Nucl. Acids Res.* **16**, 7351-67.
3. Ho, S.N. *et al.* (1989) Site-directed mutagenesis by overlap extension using the polymerase chain reaction. *Gene* **77**, 51-9.
4. Yoshimura, H. *et al.* (1986) Biological characteristics of palindromic DNA (II). *J. Gen. Appl. Microbiol.* **32**, 393-404.

## 8. Composition of Buffers and Solutions

### Blue/Orange 6X Loading Dye

0.03%	bromophenol blue
0.03%	xylene cyanol FF
0.4%	orange G
15%	Ficoll® 400
10mM	Tris-HCl (pH 7.5)
50mM	EDTA (pH 8.0)

### 5X Flexi® Digest Buffer

50mM	Tris-HCl (pH 7.9 at 37°C)
250mM	NaCl
50mM	MgCl <sub>2</sub>
5mM	DTT
0.5mg/ml	acetylated BSA

### 2X Flexi® Ligase Buffer

60mM	Tris-HCl (pH 7.8 at 25°C)
20mM	MgCl <sub>2</sub>
20mM	DTT
2mM	ATP

Store in single-use aliquots at -20°C.  
Avoid multiple freeze-thaw cycles.

### LB plates with antibiotic

Add 15g agar to 1 liter of LB medium. Autoclave. Allow the medium to cool to 50°C before adding ampicillin to a final concentration of 100µg/ml or kanamycin to a final concentration of 25µg/ml, as appropriate for the acceptor Flexi® Vector. Pour 30-35ml of medium into 85mm petri dishes. Let the agar harden. Store at 4°C for up to 1 month or at room temperature for up to 1 week.

### LB medium (per liter)

10g	Bacto®-tryptone
5g	Bacto®-yeast extract
5g	NaCl

Adjust the pH to 7.5 with NaOH. Autoclave to sterilize. For LB plates, include 15g agar prior to autoclaving.



## 8. Composition of Buffers and Solutions (continued)

### Membrane Wash Solution

(after ethanol addition)

10mM	potassium acetate (pH 5.0)
80%	ethanol
16.7µM	EDTA (pH 8.0)

To prepare this solution, add 15ml of 95% ethanol to the supplied Membrane Wash Solution (concentrated) as described in Section 4.A, Step 1.

### Membrane Binding Solution

4.5M	guanidine isothiocyanate
0.5M	potassium acetate (pH 5.0)

### 2M Mg<sup>2+</sup> stock

20.33g	MgCl <sub>2</sub> • 6H <sub>2</sub> O
24.65g	MgSO <sub>4</sub> • 7H <sub>2</sub> O

Add distilled water to 100ml. Filter-sterilize.

### SOC medium (100ml)

2.0g	Bacto <sup>®</sup> -tryptone
0.5g	Bacto <sup>®</sup> -yeast extract
1ml	1M NaCl
0.25ml	1M KCl
1ml	2M Mg <sup>2+</sup> stock, filter-sterilized
1ml	2M glucose, filter-sterilized

Add Bacto<sup>®</sup>-tryptone, Bacto<sup>®</sup>-yeast extract, NaCl and KCl to 97ml of distilled water. Stir to dissolve. Autoclave and cool to room temperature. Add 2M Mg<sup>2+</sup> stock and 2M glucose, each to a final concentration of 20mM. Bring the volume to 100ml with sterile, distilled water. The final pH should be 7.0.

### TE buffer

10mM	Tris-HCl (pH 8.0)
1mM	EDTA

## 9. Appendix

### 9.A. Flexi<sup>®</sup> Vector Systems Technology

The Flexi<sup>®</sup> Vector Systems employ a directional cloning method using two infrequently cutting restriction endonucleases: SgfI and PmeI. This simple design allows high-fidelity transfer of protein-coding regions between different vectors, each containing unique expression or peptide tag options. The advantages of this approach are minimal amino acid appendages to the protein-coding region, easy adaptation to high-throughput formats, and the ability to verify the sequence of one clone and transfer the insert to other Flexi<sup>®</sup> Vectors without resequencing. The Flexi<sup>®</sup> Vectors contain a universal lethal gene, barnase, which encodes a ribonuclease. The barnase gene must be replaced with an insert for survival of the desired clone, allowing high-efficiency transfer of a protein-coding region between vector backbones. It is lethal in strains commonly used for plasmid propagation and protein expression, so it is not possible to propagate Flexi<sup>®</sup> Vectors in these strains without replacing the barnase gene.

The SgfI site is placed one base upstream of the start codon. This allows de novo initiation at the native translation start site in Flexi<sup>®</sup> Vectors that are not designed to produce fusion proteins and readthrough of the SgfI site in

Flexi® Vectors that produce N-terminal fusion proteins. Protein-coding regions transferred into N-terminal fusion vectors allow translational readthrough of the SgfI site, which encodes the peptide sequence Ala-Ile-Ala (Figure 6).

The PmeI site is placed at the carboxy terminus, appending a single valine residue to the last amino acid of the protein-coding region (Figure 8). The valine codon, GTT, is immediately followed by an ochre stop codon, TAA. Unlike SgfI, which produces a 2-base-pair 3' overhang upon digestion, PmeI produces a blunt end by cutting in the middle of the palindrome GTTTAAAC. When a protein-coding region, flanked by SgfI and PmeI sites, is cloned into a vector cut with SgfI and PmeI, the translation stop codon is recreated. As this is a flexible system, you can design your PCR primers to place the PmeI site downstream of the protein-coding region's native stop codon, so translation terminates at the native stop codon and a valine residue is not appended to the protein. However, in doing so, you lose the ability to express the protein with a carboxy-terminal fusion tag. A carboxy-terminal fusion protein can be created by fusing the blunt-cut PmeI end of the protein-coding region with the blunt end generated by a different restriction enzyme (e.g., EcoICRI). When the blunt ends of PmeI and EcoICRI are joined, the stop codon is not regenerated and a Ser codon that is in frame with the downstream C-terminal protein-coding region contained on the Flexi® Vector backbone is created (Figure 7).



**Figure 6.** Protein-coding regions transferred into N-terminal Flexi® vectors allow translational readthrough of the SgfI site, which encodes the peptide sequence Ala-Ile-Ala.

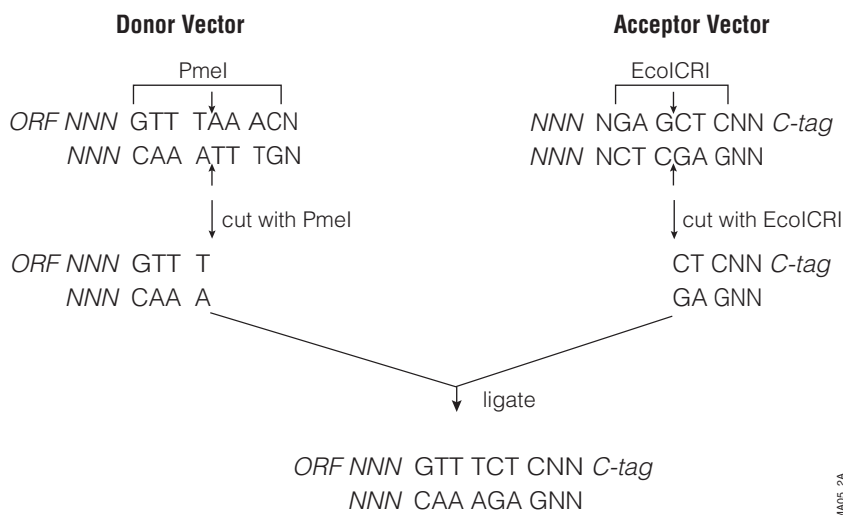

**Figure 7.** Joining the blunt ends of PmeI and EcoICRI creates an in-frame Ser codon that appends the downstream C-terminal protein-coding region contained on the Flexi® Vector backbone.



**9.B. Flexi® Vector and HaloTag® Flexi® Vector Descriptions**

Flexi® Vector Name <sup>1</sup>	Cat.#	Drug Selection	Expression Application	Promoter for Expression			Peptide Fusion Tag	
				<i>E. coli</i>	Mammalian Cells	In vitro Transcription/ Translation	N-Terminus	C-Terminus
pF1A T7 Flexi® Vector	C8441	Ampicillin	Inducible expression of native protein	T7		T7		
pF1K T7 Flexi® Vector	C8451	Kanamycin						
pFN2A (GST) Flexi® Vector	C8461	Ampicillin	Soluble expression and purification via and N-terminal GST tag	T7		T7	GST	
pFN2K (GST) Flexi® Vector	C8471	Kanamycin						
pF3A WG (BYDV) Flexi® Vector	L5671	Ampicillin	In vitro wheat germ expression of native protein			T7, SP6		
pF3K WG (BYDV) Flexi® Vector	L5681	Kanamycin						
pF4A CMV Flexi® Vector	C8481	Ampicillin	Constitutive high expression of native protein		CMV	T7		
pF4K CMV Flexi® Vector	C8491	Kanamycin						
pF5A CMV-neo Flexi® Vector	C9401	Ampicillin/ Neomycin <sup>M</sup>	Constitutive high expression of native protein with selection for stable transfectants		CMV	T7		
pF5K CMV-neo Flexi® Vector	C9411	Kanamycin/ Neomycin <sup>M</sup>						
pFN6A (HQ) Flexi® Vector	C8511	Ampicillin	Protein purification via a metal affinity resin	T7		T7	HQHQHQ	
pFN6K (HQ) Flexi® Vector	C8521	Kanamycin						
pFC7A (HQ) Flexi® Vector	C8531	Ampicillin	Protein purification via a metal affinity resin	T7		T7	HQHQHQ	
pFC7K (HQ) Flexi® Vector	C8541	Kanamycin						
pF9A CMV <i>hRluc</i> -neo Flexi® Vector	C9361	Ampicillin/ Neomycin <sup>M</sup>	Constitutive high expression of native protein with selection and reporter screening for stable transfectants		CMV	T7		
pFN10A (ACT) Flexi® Vector	C9331	Ampicillin/ Neomycin	Mammalian in vivo protein:protein interaction		CMV			HSV VP16 activation domain
pN11A (BIND) Flexi® Vector	C9341	Ampicillin	Mammalian in vivo protein:protein interaction		CMV	T7		GAL4 DNA-binding domain
pF12A RM Flexi® Vector	C9431	Ampicillin	Regulated mammalian protein expression		12λOP-Mini CMV	T7		
pF12K RM Flexi® Vector	C9441	Kanamycin						
pF25A ICE T7 Flexi® Vector	L1061	Ampicillin	In vitro insect cell free expression of native protein			T7		
pF25K ICE T7 Flexi® Vector	L1081	Kanamycin						
pFN26A (BIND) <i>hRluc</i> -neo Flexi® Vector	E1380	Ampicillin/ Neomycin <sup>M</sup>	Clone and test putative transcriptional activators		CMV	T7	GAL4 DNA-binding domain	

<sup>1</sup>The "pF" indicates that the vector is a Flexi® Vector. The letter after "pF" indicates the position of any expression tags (e.g., "N" for an N-terminal expression tag; "C" for a C-terminal expression tag). The number associated with the vector specifies the type of expression and application. The letters "A" and "K" designate the bacterial drug selection for the vector (A = ampicillin and K = kanamycin).  
<sup>M</sup>Superscripted "M" indicates the vector provides resistance to the indicated drug in mammalian cells.

**9.B. Flexi® Vector and HaloTag® Flexi® Vector Descriptions (continued)**

HaloTag® Flexi® Vector Name <sup>1</sup>	Cat.#	Drug Selection	Expression Application	Promoter for Expression			Peptide Fusion Tag	
				<i>E. coli</i>	Mammalian Cells <sup>2</sup>	In vitro Transcription/ Translation	N-Terminus	C-Terminus
pFC14A HaloTag® CMV Flexi® Vector	G9651	Ampicillin	Cell imaging and protein interaction analysis; high constitutive expression		CMV			HaloTag® Protein
pFC14K HaloTag® CMV Flexi® Vector	G9661	Kanamycin						
pFC15A HaloTag® CMVd1 Flexi® Vector	G1611	Ampicillin	Cell imaging and protein interaction analysis; medium constitutive expression	T7	CMVd1	T7, SP6		HaloTag® Protein
pFC15K HaloTag® CMVd1 Flexi® Vector	G1601	Kanamycin						
pFC16A HaloTag® CMVd2 Flexi® Vector	G1591	Ampicillin	Cell imaging and protein interaction analysis; low constitutive expression	T7	CMVd2	T7, SP6		HaloTag® Protein
pFC16K HaloTag® CMVd2 Flexi® Vector	G1571	Kanamycin						
pFC17A HaloTag® CMVd3 Flexi® Vector	G1551	Ampicillin	Cell imaging and protein interaction analysis; very low constitutive expression	T7	CMVd3	T7, SP6		HaloTag® Protein
pFC17K HaloTag® CMVd3 Flexi® Vector	G1321	Kanamycin						
pFN21A HaloTag® CMV Flexi® Vector	G2821	Ampicillin	Cell imaging and protein interaction analysis; high constitutive expression		CMV	T7	HaloTag® Protein	
pFN21K HaloTag® CMV Flexi® Vector	G2831	Kanamycin						
pFN22A HaloTag® CMVd1 Flexi® Vector	G2841	Ampicillin	Cell imaging and protein interaction analysis; medium constitutive expression	T7	CMVd1	T7, SP6	HaloTag® Protein	
pFN22K HaloTag® CMVd1 Flexi® Vector	G2851	Kanamycin						
pFN23A HaloTag® CMVd2 Flexi® Vector	G2861	Ampicillin	ImagingCell imaging and protein interaction analysis; low constitutive expression	T7	CMVd2	T7, SP6	HaloTag® Protein	
pFN23K HaloTag® CMVd2 Flexi® Vector	G2871	Kanamycin						
pFN24A HaloTag® CMVd3 Flexi® Vector	G2881	Ampicillin	Cell imaging and protein interaction analysis; very low constitutive expression	T7	CMVd3	T7, SP6	HaloTag® Protein	
pFN24K HaloTag® CMVd3 Flexi® Vector	G2981	Kanamycin						

<sup>1</sup>The “pF” indicates that the vector is a Flexi® Vector. The letter after “pF” indicates the position of any expression tags (e.g., “N” for an N-terminal expression tag; “C” for a C-terminal expression tag). The number associated with the vector specifies the type of expression and application. The letters “A” and “K” designate the bacterial drug selection for the vector (A = ampicillin and K = kanamycin).

<sup>2</sup>Because overexpression of any protein may lead to mislocalization within cells, we offer a series of HaloTag® Flexi® Vectors with reduced CMV promoter strengths, named CMVd1, d2 and d3. See Table 2.

**9.B. Flexi® Vector and HaloTag® Flexi® Vector Descriptions (continued)**

HaloTag® Flexi® Vector Name <sup>1</sup>	Cat. #	Drug Selection	Expression Application	Promoter for Expression			Peptide Fusion Tag	
				<i>E. coli</i>	Mammalian Cells	In vitro Transcription/ Translation	N-Terminus	C-Terminus
pFN18A HaloTag® T7 Flexi® Vector	G2751	Ampicillin	Protein interaction analysis and protein purification	T7		T7	HaloTag® Protein	
pFN18K HaloTag® T7 Flexi® Vector	G2681	Kanamycin						
pFN19A HaloTag® T7 SP6 Flexi® Vector	G1891	Ampicillin	Protein interaction analysis	T7		T7, SP6	HaloTag® Protein	
pFN19K HaloTag® T7 SP6 Flexi® Vector	G1841	Kanamycin						
pFC20A HaloTag® T7 SP6 Flexi® Vector	G1681	Ampicillin	Protein interaction analysis	T7		T7, SP6		HaloTag® Protein
pFC20K HaloTag® T7 SP6 Flexi® Vector	G1691	Kanamycin						

<sup>1</sup>The "pF" indicates that the vector is a Flexi® Vector. The letter after "pF" indicates the position of any expression tags (e.g., "N" for an N-terminal expression tag; "C" for a C-terminal expression tag). The number associated with the vector specifies the type of expression and application. The letters "A" and "K" designate the bacterial drug selection for the vector (A = ampicillin and K = kanamycin).

**Table 2. Protein Expression Levels from HaloTag® Flexi® Vectors.**

Vector	Mammalian Expression Promoter	Relative Protein Expression Level
pFC14A, pFC14K	CMV	High
pFN21A, pFN21K	CMV	High
pFC15A, pFC15K	CMV <i>d1</i>	Moderate
pFN22A, pFN22K	CMV <i>d1</i>	Moderate
pFC16A, pFC16K	CMV <i>d2</i>	Low
pFN23A, pFN23K	CMV <i>d2</i>	Low
pFC17A, pFC17K	CMV <i>d3</i>	Ultralow
pFN24A, pFN24K	CMV <i>d3</i>	Ultralow

**!** **Note:** The HaloTag® protein contained in the HaloTag® Flexi® Vectors is HaloTag® 7, which is the second-generation commercially available HaloTag® protein. It provides increased stability with regard to both temperature and denaturants, increased solubility and faster labeling kinetics, resulting in markedly improved expression compared to the HaloTag® 2 protein contained in the pHT2 HaloTag® Vector.

### 9.C. PCR Primer Design

The Flexi® Vector Systems require SgfI and PmeI sites appended to a protein-coding region. To generate PCR products suitable for use with these vectors, incorporate an SgfI site in your amino-terminal (forward) primer and a PmeI site in your carboxy-terminal (reverse) primer. Primer design guidelines are provided below. Promega provides a Flexi® Vector System PCR primer design tool that designs your primers to meet all of these guidelines at:

[promega.com/techserv/tools/flexivector/](http://promega.com/techserv/tools/flexivector/)

1. Design your PCR primers so that there are 20–35 nucleotides complementary to the protein-coding region being amplified (Figure 8). The melting temperatures ( $T_m$ ) of the PCR primers should be within 5°C of each other.
2. The 5' ends of the primers used to generate the PCR product can have hydroxyl groups; there is no advantage to using phosphorylated primers.

#### Amino-Terminal (Forward) Primer Guidelines

See Figure 8 for an example of an amino-terminal (forward) primer.

1. Find the start codon or define the beginning of the protein-coding region that you want to express. If your DNA sequence has an alternative start codon, such as GTG or CTG, design your PCR primer to replace that start codon with ATG. If your protein-coding region lacks a start codon, append an ATG upstream of the first amino acid in the protein-coding region, and you will be able to express that region with a single methionine appended. However, you are not required to add a methionine codon, ATG, if you intend to express your protein-coding region solely as an N-terminal fusion protein.
2. Choose 20–35 nucleotides downstream of the beginning of your protein-coding region as your base PCR primer sequence. Adjust the length of the primer to provide a  $T_m$  in the range of 45–80°C.  
**Note:** High-fidelity polymerases have active proofreading exonuclease activity and perform better with longer primers.
3. Append an SgfI restriction site (5' GCGATCGC 3') to the 5' end, one base pair upstream of the start codon. To do this, append the sequence 5' GCGATCGCC 3' upstream of the ATG. The additional C residue at the 3' end of this sequence will preserve the reading frame of N-terminal fusion proteins.
4. Add 4 additional nucleotides to the 5' end of the primer. Any 4 bases will work, but avoid sequences that promote hairpin formation or annealing to the 3' end of the carboxy-terminal primer. The addition of these bases promotes more complete digestion of the PCR product by SgfI.

## Carboxy-Terminal (Reverse) Primer Guidelines

See Figure 8 for an example of a carboxy-terminal (reverse) primer.

1. Identify the stop codon or define the end of the protein-coding region you want to express.
2. Choose 20–35 nucleotides upstream of the end of your protein-coding region as your base PCR primer sequence. Adjust the length of the primer to provide a  $T_m$  in the range of 45–80°C.

**Note:** High-fidelity polymerases have active proofreading exonuclease activity and perform better with longer primers.

3. Append a PmeI restriction site (5' GTTTAAAC 3') to the 3' end of this sequence. This appends a valine codon followed by a stop codon.
4. Generate the reverse complement of this sequence.
5. Add 4 additional nucleotides to the 5' end. Any four bases will work, but avoid sequences that promote hairpin formation or annealing to the 3' end of the amino-terminal primer. These additional bases promote more complete digestion of the PCR product by PmeI.

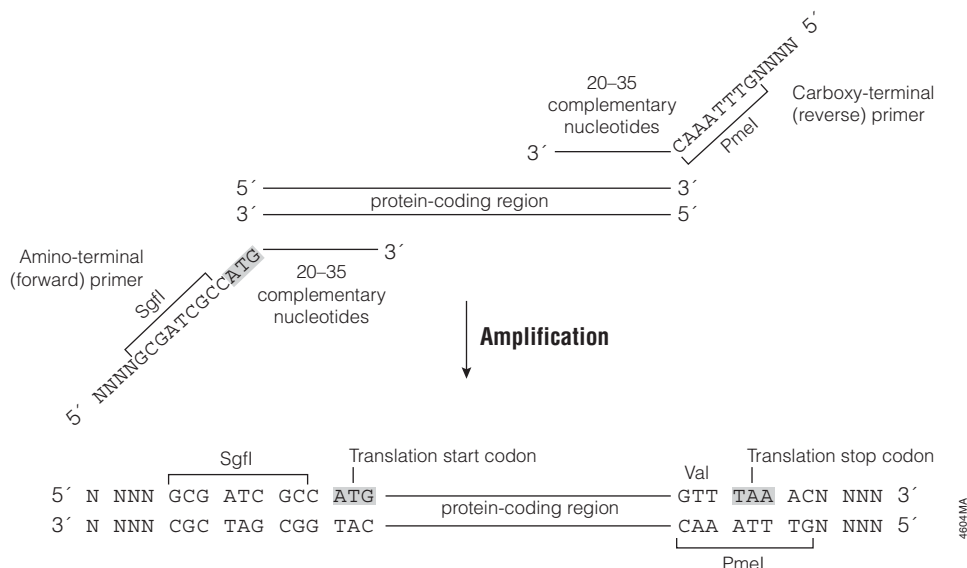

**Figure 8. PCR primer design.** The PmeI site appends a single valine codon at the 3' end of the protein-coding region and allows either termination or readthrough to append a carboxy-terminal peptide, depending on the vector backbone.

#### 9.D. Protocol for Screening Clones with SgfI and PmeI

**!** Do not use this protocol to screen for inserts in C-terminal Flexi® Vectors, which have names starting with “pFC”, since these clones lack PmeI sites.

##### Materials to Be Supplied by the User

(Solution compositions are provided in Section 8.)

- 10X Flexi® Enzyme Blend (SgfI & PmeI) (Cat.# R1851 or R1852)
- Blue/Orange 6X Loading Dye (Cat.# G1881)

1. Chill reaction components and reaction tubes or plates.
2. Prepare a master mix by combining the components listed below. Increase volumes proportionately depending on the number of reactions.

Component	Volume per Reaction
Nuclease-Free Water	10.5µl
5X Flexi® Digest Buffer	4.0µl
10X Flexi® Enzyme Blend (SgfI & PmeI)	0.5µl
Final volume	<b>15µl</b>

3. Add 15µl of master mix to 5µl (200–500ng) of plasmid DNA. Mix thoroughly by pipetting.
4. Incubate for 2 hours at 37°C.
5. Add 5µl of loading dye (Blue/Orange Loading Dye, 6X, Cat.# G1881). Incubate at 65°C for 10 minutes.
6. Load 20µl of the reaction onto a 1% agarose gel and separate fragments by electrophoresis. Visualize the fragments by ethidium bromide staining.

#### 9.E. Purification of a PCR Product From an Agarose Gel Slice

1. Load and run an agarose gel using an established protocol. DNA can be extracted from standard or low-melt agarose gels run with TAE or TBE buffer. See Note 1.
2. Weigh a 1.5ml microcentrifuge tube for each DNA fragment to be isolated, and record the weight.
3. Visualize and photograph the DNA using a long-wavelength UV lamp and an intercalating dye such as ethidium bromide. To reduce nicking and pyrimidine dimer formation, minimize exposure of the DNA to UV light. Excise the DNA fragment of interest in a minimal volume of agarose using a clean scalpel or razor blade. Transfer the gel slice to the weighed microcentrifuge tube and record the weight. Subtract the weight of the empty tube from the total weight to obtain the weight of the gel slice (see Note 2).
4. Add 10µl of Membrane Binding Solution per 10mg of agarose gel slice.
5. Vortex the mixture (see Note 3) and incubate at 50–65°C for 10 minutes or until the gel slice is completely dissolved. Vortex the tube every few minutes to increase the rate of agarose gel melting. Centrifuge the tube briefly at

room temperature to ensure the contents are at the bottom of the tube. Once the agarose is melted, the gel will not resolidify at room temperature.

6. Add 15ml of 95% ethanol to the Membrane Wash Solution. Mark the bottle label to record that this addition was made. Tightly close the bottle cap after each use to prevent evaporation.
7. At this point, the DNA can be purified using microcentrifugation to force the solution through the Wizard® SV Minicolumn and wash the DNA (proceed to the centrifugation protocol in Section 9.F). Alternatively, a vacuum can be used to pull the solution through the Minicolumn and wash the DNA (proceed to the vacuum protocol in Section 9.F). Vacuum Adapters allow the use of a vacuum manifold (e.g., a Vac-Man® Laboratory Vacuum Manifold, Cat.# A7231) and vacuum source for DNA purification.

**Notes:**

1. Recovery from 1% high-melting-point agarose is comparable to that from 1–2% low-melting-point agarose. High-melting-point agarose concentrations of up to 3% have been tested. Gel slices with higher agarose concentrations (2–3%) may require a longer time to melt completely than a 1% agarose gel slice and may result in reduced yields.
2. The maximum binding capacity of the column is approximately 40µg per column and as little as 10ng has been successfully purified. The maximum capacity of the column is 350mg of gel mass dissolved in 350µl of Membrane Binding Solution per column pass. For gel slices >350mg, continue to pass additional sample through the SV Minicolumn until all of the sample has been processed. The maximal amount of agarose that can be processed through a single column is approximately 3.5g (10 × 350mg).
3. Do not vortex if the DNA fragment is larger than 5kb; mix by inversion. DNA fragments that are larger than 5kb should be mixed gently to prevent shearing.

**9.F. Centrifugation and Vacuum Protocols for PCR Product Purification**

Instructions for preparing a PCR product for direct purification are provided in Section 4.A, Steps 1 and 2. Instructions for preparing a PCR product to be purified from an agarose gel slice are provided in Section 9.E.

**Centrifugation Protocol**

1. Place one SV Minicolumn in a Collection Tube for each dissolved gel slice or prepared PCR product.
2. Transfer the dissolved gel mixture or prepared PCR product to the SV Minicolumn assembly and incubate for 1 minute at room temperature.
3. Centrifuge the SV Minicolumn assembly in a microcentrifuge at 16,000 × *g* (14,000 rpm) for 1 minute. Remove the SV Minicolumn from the Spin Column assembly and discard the liquid in the Collection Tube. Return the SV Minicolumn to the Collection Tube.

**9.F. Centrifugation and Vacuum Protocols for PCR Product Purification  
(continued)**

4. Wash the column by adding 700 $\mu$ l of Membrane Wash Solution, previously diluted with 95% ethanol, to the SV Minicolumn. Centrifuge the SV Minicolumn assembly for 1 minute at 16,000  $\times$  *g*. Empty the Collection Tube as before and place the SV Minicolumn back in the Collection Tube. Repeat the wash with 500 $\mu$ l of prepared Membrane Wash Solution and centrifuge the SV Minicolumn assembly for 5 minutes at 16,000  $\times$  *g*.
5. Remove the SV Minicolumn assembly from the centrifuge, being careful not to wet the bottom of the column with the flowthrough. Empty the Collection Tube, return the SV Minicolumn to the Collection Tube and re-centrifuge the column assembly for 1 minute with the microcentrifuge lid open (or off) to allow evaporation of any residual ethanol.
6. Carefully transfer the SV Minicolumn to a clean 1.5ml microcentrifuge tube. Apply 50 $\mu$ l of Nuclease-Free Water directly to the center of the column without touching the membrane with the pipette tip. Incubate at room temperature for 1 minute. Centrifuge for 1 minute at 16,000  $\times$  *g* (see Note).
7. Discard the SV Minicolumn and store the microcentrifuge tube containing the eluted DNA at 4°C or -20°C.

**Note:** The volume of the eluted DNA will be approximately 42–47 $\mu$ l. If the DNA needs to be further concentrated, perform an ethanol precipitation. Alternatively, the DNA may be eluted in as little as 15 $\mu$ l of Nuclease-Free Water without a significant reduction in yield. If using an elution volume of 15 $\mu$ l, verify that the membrane is completely covered with Nuclease-Free Water before centrifugation. Do not elute in volumes less than 15 $\mu$ l (see Table 4 in Section 9.H.).



---

## Vacuum Protocol

1. Attach one Vacuum Adapter with a Luer-Lok® fitting to one port of the manifold (e.g., Vac-Man® or Vac-Man® Jr. Laboratory Vacuum Manifold) for each dissolved gel slice or prepared PCR product. Insert an SV Minicolumn into each Vacuum Adapter until it fits snugly in place.
2. Transfer the dissolved gel mixture or prepared PCR product to the SV Minicolumn and incubate for 1 minute at room temperature. Apply a vacuum to pull the liquid completely through the SV Minicolumn.  
**Note:** The minimum vacuum pressure is 15 inches of mercury.
3. Wash the column by adding 700µl of Membrane Wash Solution, previously diluted with 95% ethanol, to the SV Minicolumn. Make sure that any droplets remaining on the sides of the SV Minicolumn are washed away. Apply a vacuum to pull the liquid through the SV Minicolumn. Repeat this wash a second time with 500µl of prepared Membrane Wash Solution.
4. Turn off the vacuum source and open an unused port to vent the manifold. Remove the SV Minicolumn from the vacuum manifold and transfer the SV Minicolumn to a Collection Tube. Centrifuge the SV Minicolumn assembly for 5 minutes at 16,000 × g (14,000 rpm) to remove any remaining Membrane Wash Solution from the column.
5. Empty the Collection Tube and recentrifuge the column assembly for 1 minute with the microcentrifuge lid open (or off) to allow evaporation of any residual ethanol.
6. Carefully transfer the SV Minicolumn to a clean 1.5ml microcentrifuge tube. Apply 50µl of Nuclease-Free Water directly to the center of the column without contacting the membrane. Incubate at room temperature for 1 minute. Centrifuge for 1 minute at 16,000 × g (see Note).
7. Discard the SV Minicolumn and store the microcentrifuge tube containing the eluted DNA at 4°C or -20°C.

**Note:** The volume of the eluted DNA will be approximately 42–47µl. If the DNA needs to be further concentrated, perform an ethanol precipitation. Alternatively, the DNA may be eluted in as little as 15µl of Nuclease-Free Water without a significant reduction in yield. If using an elution volume of 15µl, verify that the membrane is completely covered with Nuclease-Free Water before centrifugation. Do not elute in volumes less than 15µl (see Table 4 in Section 9.H).

## 9.G. Transformation Protocol

Selection for transformants should be performed on LB plates supplemented with either 100µg/ml ampicillin or 25µg/ml kanamycin, as appropriate for the acceptor Flexi® Vector. See Table 1 for a list of antibiotic resistance genes carried on the various vectors.

### Materials to Be Supplied by the User

(Solution compositions are provided in Section 8.)

- LB plates with 100µg/ml ampicillin or 25µg/ml kanamycin, as appropriate for the acceptor Flexi® Vector
- SOC medium

1. Equilibrate 2 plates per transformation to room temperature.
2. Centrifuge the tubes containing the ligation reactions to collect contents at the bottom of the tube. Add 2µl of each ligation reaction to a sterile 1.5ml microcentrifuge tube on ice.

**Note:** In our experience, the use of larger (17 × 100mm) polypropylene tubes (e.g., Falcon®, BD Cat.# 352059) has been observed to increase transformation efficiency. Tubes from some manufacturers bind DNA, thereby decreasing the colony number, and should be avoided.

3. Remove tube(s) of frozen high-efficiency JM109 Competent Cells from -70°C storage and place in an ice bath until just thawed (about 5 minutes). Mix the cells by gently flicking the tube.
4. Carefully transfer 50µl of cells into each tube prepared in Step 2.
5. Gently flick the tubes to mix and place them on ice for 20 minutes.
6. Heat-shock the cells for 45–50 seconds in a water bath at exactly 42°C. Do not shake.
7. Immediately return the tubes to ice for 2 minutes.
8. Add 950µl of room-temperature SOC medium to each tube (LB broth may be substituted, but colony number may be lower).
9. Incubate for 1.5 hours at 37°C with shaking (approximately 150 rpm).
10. Plate 20–50µl of each transformation onto duplicate plates containing either 100µg/ml ampicillin or 25µg/ml kanamycin, as appropriate for the acceptor Flexi® Vector.
11. Incubate the plates overnight (16–24 hours) at 37°C. In our experience, approximately 300 colonies per plate are routinely seen when using competent cells that are  $1 \times 10^8$ cfu/µg DNA if 20µl is plated.

## 9.H. Efficiency of Recovery of DNA Fragments

This system uses the Wizard® SV Minicolumns to clean up the PCR product prior to cloning. The percent recovery depends upon the size of the DNA fragment (Table 3) and the elution volume (Table 4).

**Table 3. Percent Recovery Versus Double-Stranded DNA Fragment Size.**

DNA Fragment Size	Percent Recovery
55bp	26%
70bp	39%
85bp	55%
100bp	84%
500bp	89%
1,000bp	92%
3,199bp	95%
9,416bp	95%
23,130bp	47%

**Table 4. Percent Recovery Versus Elution Volume.**

Elution Volume	Percent Recovery Compared to 50µl
10µl	35%
15µl	98%
25µl	98%
50µl	100%
75µl	100%
100µl	100%

### 9.I. Related Products

Product	Size	Cat.#
10X Flexi® Enzyme Blend (Sgfl & Pmel)	25µl	R1851
	100µl	R1852
Sgfl*	250 units	R7103
	1,250 units	R5104
EcoICRI*	1,000 units	R6951
JM109 Competent Cells, >10 <sup>8</sup> cfu/µg*	5 × 200µl	L2001
BL21(DE3)pLysS Competent Cells, >10 <sup>6</sup> cfu/µg	5 × 200µl	L1191

\*For Laboratory Use.

Product	Size	Cat.#
HaloCHIP™ System	20 reactions	G9410

### Transfection Reagents

Product	Size	Cat.#
TransFast™ Transfection Reagent	1.2mg	E2431
Tfx™-20 Reagent	4.8mg	E2391
Tfx™-50 Reagent	2.1mg	E1811
ProFection® Mammalian Transfection System – Calcium Phosphate	40 reactions	E1200

### Transfection-Quality DNA Purification

Product	Size	Cat.#
PureYield™ Plasmid Midiprep System	25 preps	A2492
	100 preps	A2495
Wizard MagneSil Tfx™ System	4 × 96 preps	A2380

**DNA Purification Systems**

<b>Product</b>	<b>Size</b>	<b>Cat.#</b>
Wizard® SV Gel and PCR Clean-Up System	50 preps	A9281
	250 preps	A9282
Wizard® SV 96 PCR Clean-Up System	1 × 96 preps	A9340
	4 × 96 preps	A9341
	8 × 96 preps	A9342
	100 × 96 preps	A9345
Wizard® <i>Plus</i> SV Minipreps DNA Purification System	50 preps	A1330

**Protein Purification Systems**

<b>Product</b>	<b>Size</b>	<b>Cat.#</b>
MagneGST™ Protein Purification System	40 reactions	V8600
	200 reactions	V8603
MagneGST™ Glutathione Particles	4ml	V8611
	20ml	V8612
MagneHis™ Protein Purification System	65 reactions	V8500
	325 reactions	V8550
MagneHis™ Ni-Particles	2ml	V8560
	10ml	V8565
MagZ™ Protein Purification System	30 reactions	V8830
HisLink™ 96 Protein Purification System	1 × 96 reactions	V3680
	5 × 96 reactions	V3681
HisLink™ Protein Purification Resin	50ml	V8821
HaloLink™ Resin	2ml	G1911
	5ml	G1912
HaloLink™ Array (TnT® T7 Quick) Two Slide System	two 50-well arrays	G6140
HaloLink™ Array (TnT® SP6 Wheat Germ) Two Slide System	two 50-well arrays	G6180

**HaloTag® Ligands**

<b>Product</b>	<b>Size</b>	<b>Cat.#</b>
HaloTag® TMR Ligand	30µl	G8251
HaloTag® diAcFAM Ligand	30µl	G8272
HaloTag® Coumarin Ligand	30µl	G8581
HaloTag® Biotin Ligand	30µl	G8281
HaloTag® PEG-Biotin Ligand	30µl	G8591



**9.I. Related Products (continued)**

**Protein Expression Systems**

<b>Product</b>	<b>Size</b>	<b>Cat.#</b>
TNT® T7 Quick Coupled Transcription/Translation System	40 reactions	L1170
TNT® T7 Quick Coupled Transcription/Translation System, Trial Size*	5 reactions	L1171
TNT® SP6 Quick Coupled Transcription/Translation System	40 reactions	L2080
TNT® SP6 Quick Coupled Transcription/Translation System, Trial Size	5 reactions	L2081
Wheat Germ Extract Plus	40 × 50µl reactions	L3250
	10 × 50µl reactions	L3251

\*For Laboratory Use.

<sup>(a)</sup>Patent Pending.

<sup>(b)</sup>For research use only. Persons wishing to use this product or its derivatives in other fields of use, including without limitation, commercial sale, diagnostics or therapeutics, should contact Promega Corporation for licensing information.

<sup>(c)</sup>U.S. Pat. No. 5,391,487.

<sup>(d)</sup>Licensed under U.S. Pat. No. 5,945,288.

© 2004, 2005, 2007, 2009, 2010 Promega Corporation. All Rights Reserved.

Flexi, HaloTag, pGEM, ProFection, TNT, Vac-Man and Wizard are registered trademarks of Promega Corporation. HaloCHIP, HaloLink, HisLink, MagneGST, MagneHis, MagZ, PureYield, Tfx and TransFast are trademarks of Promega.

Bacto is a registered trademark of Difco Laboratories, Detroit, Michigan. Falcon and Luer-Lok are registered trademarks of Becton, Dickinson and Company. Ficoll is a registered trademark of GE Healthcare Bio-sciences.

Products may be covered by pending or issued patents or may have certain limitations. Please visit our Web site for more information.

All prices and specifications are subject to change without prior notice.

Product claims are subject to change. Please contact Promega Technical Services or access the Promega online catalog for the most up-to-date information on Promega products.