

## QIAquick® Spin Handbook

### QIAquick PCR Purification Kit

For purification of PCR products, 100 bp to 10 kb

### QIAquick Nucleotide Removal Kit

For oligonucleotide (17–40mers) and DNA  
(40 bp to 10 kb) cleanup from enzymatic reactions

### QIAquick Gel Extraction Kit

For gel extraction or cleanup of DNA  
(70 bp to 10 kb) from enzymatic reactions



## QIAGEN Sample and Assay Technologies

QIAGEN is the leading provider of innovative sample and assay technologies, enabling the isolation and detection of contents of any biological sample. Our advanced, high-quality products and services ensure success from sample to result.

### **QIAGEN sets standards in:**

- Purification of DNA, RNA, and proteins
- Nucleic acid and protein assays
- microRNA research and RNAi
- Automation of sample and assay technologies

Our mission is to enable you to achieve outstanding success and breakthroughs. For more information, visit [www.qiagen.com](http://www.qiagen.com).

# Contents

<b>Kit Contents</b>	<b>4</b>
<b>Storage</b>	<b>4</b>
<b>Intended Use</b>	<b>5</b>
<b>Safety Information</b>	<b>5</b>
<b>Quality Control</b>	<b>5</b>
<b>Product Specifications</b>	<b>6</b>
<b>Introduction</b>	<b>7</b>
<b>The QIAquick Principle</b>	<b>10</b>
<b>Equipment and Reagents to Be Supplied by User</b>	<b>17</b>
<b>Protocols</b>	
■ QIAquick PCR Purification Kit using a Microcentrifuge	18
■ QIAquick PCR Purification Kit using a Vacuum Manifold	20
■ QIAquick Nucleotide Removal Kit using a Microcentrifuge	22
■ QIAquick Gel Extraction Kit using a Microcentrifuge	24
■ QIAquick Gel Extraction Kit using a Vacuum Manifold	26
<b>Troubleshooting Guide</b>	<b>29</b>
<b>Appendix: QIAvac Vacuum Manifolds</b>	<b>32</b>
<b>References</b>	<b>34</b>
<b>Ordering Information</b>	<b>35</b>

## Kit Contents

<b>QIAquick PCR Purification Kit</b>	<b>(50)</b>	<b>(250)</b>
<b>Catalog no.</b>	<b>28104</b>	<b>28106</b>
QIAquick Spin Columns	50	250
Buffer PB*	30 ml	150 ml
Buffer PE (concentrate)	2 x 6 ml	55 ml
Buffer EB	15 ml	55 ml
pH Indicator I	800 µl	800 µl
Collection Tubes (2 ml)	50	250
Loading Dye	110 µl	550 µl
Quick-Start Protocol	1	1

<b>QIAquick Nucleotide Removal Kit</b>	<b>(50)</b>	<b>(250)</b>
<b>Catalog no.</b>	<b>28304</b>	<b>28306</b>
QIAquick Spin Columns	50	250
Buffer PNI* (concentrate)	12.5 ml	56 ml
Buffer PE (concentrate)	2 x 6 ml	55 ml
Buffer EB	15 ml	55 ml
Collection Tubes (2 ml)	100	500
Loading Dye	110 µl	550 µl
Quick-Start Protocol	1	1

<b>QIAquick Gel Extraction Kit</b>	<b>(50)</b>	<b>(250)</b>
<b>Catalog no.</b>	<b>28704</b>	<b>28706</b>
QIAquick Spin Columns	50	250
Buffer QG*	2 x 50 ml	2 x 250 ml
Buffer PE (concentrate)	2 x 10 ml	2 x 55 ml
Buffer EB	15 ml	2 x 15 ml
Collection Tubes (2 ml)	50	250
Loading Dye	110 µl	550 µl
Quick-Start Protocol	1	1

\* Buffers PB, PNI, and QG contain chaotropic salts, which are irritants. Take appropriate laboratory safety measures and wear gloves when handling.

## Storage

QIAquick Kits should be stored dry at room temperature (15–25°C). Under these conditions, QIAquick Kits can be stored for up to 12 months without showing any reduction in performance and quality. Check buffers for precipitate before use and redissolve at 37°C if necessary. The entire kit can be stored at 2–8°C, but in this case the buffers should be redissolved before use. Make sure that all buffers and spin columns are at room temperature when used.

## Intended Use

QIAquick PCR Purification, QIAquick Nucleotide Removal, and QIAquick Gel Extraction Kits are intended for molecular biology applications. These products are not intended for the diagnosis, prevention, or treatment of a disease.

All due care and attention should be exercised in the handling of the products. We recommend all users of QIAGEN® products to adhere to the NIH guidelines that have been developed for recombinant DNA experiments, or to other applicable guidelines.

## Safety Information

When working with chemicals, always wear a suitable lab coat, disposable gloves, and protective goggles. For more information, please consult the appropriate material safety data sheets (MSDSs). These are available online in convenient and compact PDF format at [www.qiagen.com/ts/msds.asp](http://www.qiagen.com/ts/msds.asp) where you can find, view, and print the MSDS for each QIAGEN kit and kit component.



**CAUTION: DO NOT add bleach or acidic solutions directly to the sample-preparation waste.**

Buffer PB contains guanidine hydrochloride, which can form highly reactive compounds when combined with bleach.

In case liquid containing this buffer is spilt, clean with suitable laboratory detergent and water. If the spilt liquid contains potentially infectious agents, clean the affected area first with laboratory detergent and water, and then with 1% (v/v) sodium hypochlorite.

### 24-hour emergency information

Emergency medical information in English, French, and German can be obtained 24 hours a day from:

Poison Information Center Mainz, Germany

Tel: +49-6131-19240

## Quality Control

In accordance with QIAGEN's ISO-certified Quality Management System, each lot of QIAquick PCR Purification, QIAquick Nucleotide Removal, and QIAquick Gel Extraction Kits is tested against predetermined specifications to ensure consistent product quality.

## Product Specifications

	QIAquick PCR Purification Kit	QIAquick Nucleotide Removal Kit	QIAquick Gel Extraction Kit
Maximum binding capacity	10 µg	10 µg	10 µg
Maximum weight of gel slice	–	–	400 mg
Minimum elution volume	30 µl	30 µl	30 µl
Capacity of column reservoir	800 µl	800 µl	800 µl
<b>Typical recoveries</b>			
Recovery of DNA	90–95% (100 bp – 10 kb)	80–95% (40 bp – 10 kb)	70–80% (70 bp – 10 kb)
Recovery of oligonucleotides (17–40mers)	0	60–80%	10–20%
<b>Recovered</b>			
Oligonucleotides	–	17–40mers	–
dsDNA	100 bp – 10 kb	40 bp – 10 kb	70 bp – 10 kb
<b>Removed</b>			
<10mers	<b>YES</b>	<b>YES</b>	<b>YES</b>
17–40mers	<b>YES</b>	No	No

## Introduction

The QIAquick system, designed for rapid DNA cleanup, includes the following kits:

- **QIAquick PCR Purification Kit** for direct purification of double- or single-stranded PCR products (100 bp – 10 kb) from amplification reactions and DNA cleanup from other enzymatic reactions.
- **QIAquick Nucleotide Removal Kit** for general cleanup of oligonucleotides and DNA up to 10 kb from enzymatic reactions (e.g., labeling, dephosphorylation, restriction, and tailing).
- **QIAquick Gel Extraction Kit** for extraction of DNA fragments (70 bp – 10 kb) from standard or low-melt agarose gels in TAE buffer (Tris-acetate/EDTA) or TBE buffer (Tris-borate/ EDTA) and DNA cleanup from enzymatic reactions.

### Enzymatic reaction cleanup using QIAquick Kits

The QIAquick system is suitable for fast cleanup of up to 10 µg of DNA fragments from enzymatic reactions and agarose gels (Table 1). Enzyme contamination of DNA samples can interfere with subsequent downstream applications. QIAquick Kits can be used for highly efficient removal of a broad spectrum of enzymes widely used in molecular biology. In addition, QIAGEN offers the MinElute® Reaction Cleanup Kit, which is specially designed for fast and easy DNA cleanup from enzymatic reactions. Using proven microspin technology, the MinElute Reaction Cleanup Kit delivers highly concentrated purified DNA by using an elution volume of only 10 µl (see ordering information, page 35).

**Table 1. QIAquick DNA Cleanup Guide**

	From solutions			From gels
	QIAquick PCR Purification Kit	QIAquick Nucleotide Removal Kit	QIAquick Gel Extraction Kit	QIAquick Gel Extraction Kit
Alkaline phosphatase	<b>YES</b>	<b>YES</b>	<b>YES</b>	<b>YES</b>
cDNA synthesis	<b>YES</b>	No	No	<b>YES</b>
DNase, nuclease digestion	<b>YES</b>	<b>YES</b>	<b>YES</b>	<b>YES</b>
Kinase:				
DNA fragments	<b>YES</b>	<b>YES</b>	<b>YES</b>	<b>YES</b>
Oligonucleotides	No	<b>YES</b>	No	No
Ligation	<b>YES</b>	<b>YES</b>	<b>YES</b>	<b>YES</b>
Nick translation	<b>YES</b>	<b>YES</b>	<b>YES</b>	<b>YES</b>
PCR	<b>YES</b>	No	No	<b>YES</b>
Random priming	<b>YES</b>	<b>YES</b>	<b>YES</b>	<b>YES</b>
Restriction digestion	<b>YES</b>	<b>YES</b>	<b>YES</b>	<b>YES</b>
Tailing:				
DNA fragments	<b>YES</b>	<b>YES</b>	<b>YES</b>	<b>YES</b>
Oligonucleotides	No	<b>YES</b>	No	No

QIAquick Kits provide high yields of pure nucleic acids, for direct use in applications such as:

- Fluorescent and radioactive sequencing
- Restriction
- Labeling
- Hybridization
- Ligation and transformation
- Amplification
- In vitro transcription
- Microinjection



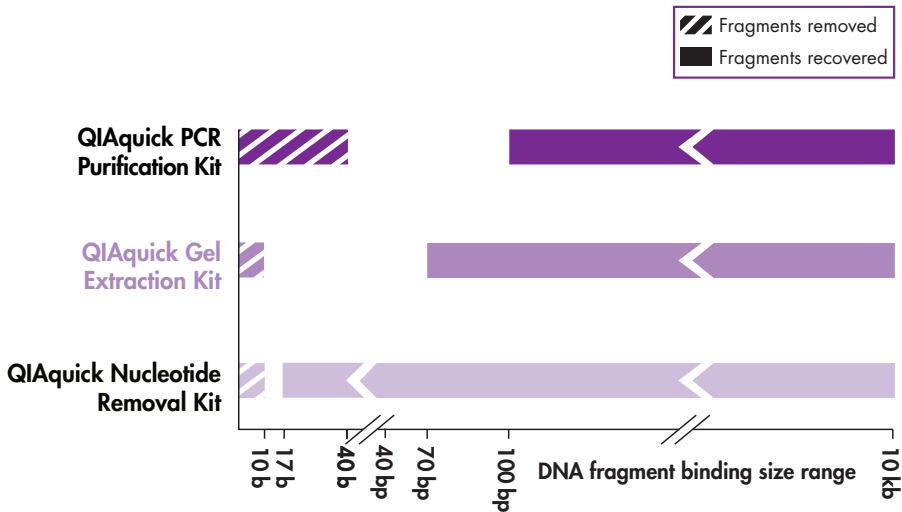

**Figure 1. DNA fragment binding-size range.** Recoveries of DNA fragments in the size range between “removed” and “recovered” are not defined.

### Automated DNA cleanup

The QIAquick PCR Purification Kit and QIAquick Gel Extraction Kit can be fully automated on the QIAcube®. The innovative QIAcube uses advanced technology to process QIAGEN spin columns, enabling seamless integration of automated, low-throughput sample prep into your laboratory workflow. Sample preparation using the QIAcube follows the same steps as the manual procedure (i.e., bind, wash, and elute) enabling purification of high-quality DNA.

The QIAcube is preinstalled with protocols for purification of plasmid DNA, genomic DNA, RNA, viral nucleic acids, and proteins, plus DNA and RNA cleanup. The range of protocols available is continually expanding, and additional QIAGEN protocols can be downloaded free of charge at [www.qiagen.com/MyQIAcube](http://www.qiagen.com/MyQIAcube).

A detailed protocol for using QIAquick spin columns on the QIAcube is provided with the QIAcube.

**Note:** It is not necessary to add pH Indicator I to Buffer PB when using the QIAcube.

## The QIAquick Principle

The QIAquick system combines the convenience of spin-column technology with the selective binding properties of a uniquely designed silica membrane. Special buffers provided with each kit are optimized for efficient recovery of DNA and removal of contaminants in each specific application. DNA adsorbs to the silica membrane in the presence of high concentrations of salt, while contaminants pass through the column. Impurities are efficiently washed away, and pure DNA is eluted with Tris buffer or water (see page 16). QIAquick spin columns offer 3 handling options — as an alternative to processing spin columns in a microcentrifuge, they can now also be used on any commercial vacuum manifold with luer connectors (e.g., QIAvac 24 Plus with QIAvac Luer Adapters) or automated on the QIAcube.

### Adsorption to QIAquick membrane — salt and pH dependence

The QIAquick silica membrane is uniquely adapted to purify DNA from both aqueous solutions and agarose gels, and up to 10  $\mu\text{g}$  DNA can bind to each QIAquick column. The binding buffers in QIAquick Kits provide the correct salt concentration and pH for adsorption of DNA to the QIAquick membrane. The adsorption of nucleic acids to silica surfaces occurs only in the presence of a high concentration of chaotropic salts (1), which modify the structure of water (2).

Adsorption of DNA to silica also depends on pH. Adsorption is typically 95% if the pH is  $\geq 7.5$ , and is reduced drastically at higher pH (Figure 2). If the loading mixture pH is  $>7.5$ , the optimal pH for DNA binding can be obtained by adding a small volume of 3 M sodium acetate, pH 5.0.

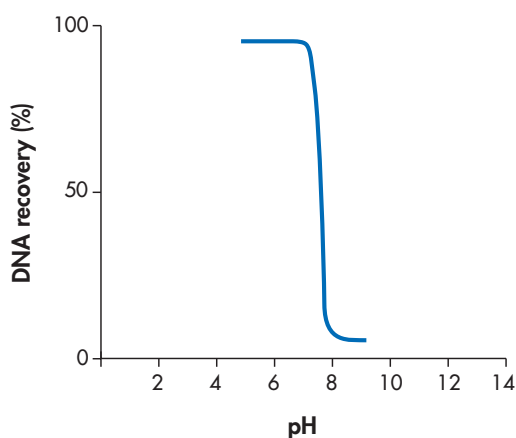

**Figure 2. pH dependence of DNA adsorption to QIAquick membranes.** 1  $\mu\text{g}$  of a 2.9 kb DNA fragment was adsorbed at different pH values and eluted with Buffer EB (10 mM Tris-Cl, pH 8.5). The graph shows the percentage of DNA recovery, reflecting the relative adsorption efficiency, versus pH of adsorption.

## Optimized binding buffers for every DNA cleanup task

All QIAquick Kits contain identical QIAquick spin columns but different binding buffers optimized for each specific application:

- Buffer PB in the QIAquick PCR Purification Kit allows the efficient binding of single- or double-stranded PCR products as small as 100 bp and the quantitative (99.5%) removal of primers up to 40 nucleotides. This kit can therefore be used to remove oligo-dT primers after cDNA synthesis or to remove unwanted linkers in cloning experiments.
- Buffer PNI in the QIAquick Nucleotide Removal Kit promotes the adsorption of both oligonucleotides  $\geq 17$  bases and DNA fragments up to 10 kb to the membrane.
- Buffer QG in the QIAquick Gel Extraction Kit solubilizes the agarose gel slice and provides the appropriate conditions for binding of DNA to the silica membrane.

All of these buffers are available separately (see ordering information, page 35).

### pH Indicator

Binding buffer PB and binding and solubilization buffer QG are specially optimized for use with the QIAquick silica membrane. Buffer QG contains an integrated pH Indicator, while an optional pH Indicator can be added to Buffer PB allowing easy determination of the optimal pH for DNA binding. DNA adsorption requires a pH  $\geq 7.5$ , and the pH Indicator in the buffers will appear yellow in this range. If the pH is  $>7.5$ , which can occur if during agarose gel electrophoresis, the electrophoresis buffer had been used repeatedly or incorrectly prepared, or if the buffer used in an enzymatic reaction is strongly basic and has a high buffering capacity, the binding mixture turns orange or violet (Figure 2). This means that the pH of the sample exceeds the buffering capacity of Buffer PB or QG and DNA adsorption will be inefficient. In these cases, the pH of the binding mixture can easily be corrected by addition of a small volume of 3 M sodium acetate\*, pH 5.0, before proceeding with the protocol. In addition, in the QIAquick Gel

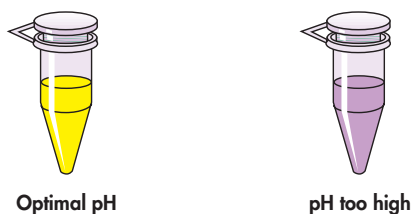

**Figure 3. Indicator enables easy checking of the optimal pH.** Indicator dye in solubilization and binding buffers (Buffer QG and Buffer PB) identifies optimal pH for DNA binding.

\* When working with chemicals, always wear a suitable lab coat, disposable gloves, and protective goggles. For more information, please consult the appropriate material safety data sheets (MSDSs) available from the product supplier.

Extraction Kit procedure, the color of the binding mixture allows easy visualization of any unsolubilized agarose, ensuring complete solubilization and maximum yields. The indicator dye does not interfere with DNA binding and is completely removed during the cleanup procedure. Buffers PB and QG do not contain sodium iodide (NaI). Residual NaI may be difficult to remove from DNA samples, and reduces the efficiency of subsequent enzymatic reactions such as blunt-end ligation.

### **Washing**

During the DNA adsorption step, unwanted primers and impurities, such as salts, enzymes, unincorporated nucleotides, agarose, dyes, ethidium bromide, oils, and detergents (e.g., DMSO, Tween® 20) do not bind to the silica membrane but flow through the column. Salts are quantitatively washed away by the ethanol-containing Buffer PE. Any residual Buffer PE, which may interfere with subsequent enzymatic reactions, is removed by an additional centrifugation step.

### **Elution in low-salt solutions**

Elution efficiency is strongly dependent on the salt concentration and pH of the elution buffer. Contrary to adsorption, elution is most efficient under basic conditions and low salt concentrations. DNA is eluted with 50 µl or 30 µl of the provided Buffer EB (10 mM Tris-Cl, pH 8.5), or water. The maximum elution efficiency is achieved between pH 7.0 and 8.5. When using water to elute, make sure that the pH is within this range. In addition, DNA must be stored at -20°C when eluted with water since DNA may degrade in the absence of a buffering agent. Elution with TE buffer (10 mM Tris-Cl, 1 mM EDTA, pH 8.0) is possible, but not recommended because EDTA may inhibit subsequent enzymatic reactions.

### **DNA yield and concentration**

DNA yield depends on the following three factors: the volume of elution buffer, how the buffer is applied to the column, and the incubation time of the buffer on the column. To completely cover the QIAquick membrane, use 100–200 µl elution buffer. This ensures maximum yield, even when not applied directly to the center of the membrane. Elution with ≤50 µl requires the buffer to be added directly to the center of the membrane, and if elution is done with the minimum recommended volume of 30 µl, an additional 1 minute incubation is required for optimal yield. DNA will be up to 1.7 times more concentrated if the QIAquick column is incubated for 1 minute with 30 µl of elution buffer, than if it is eluted in 50 µl without incubation (Figure 4, page 13).

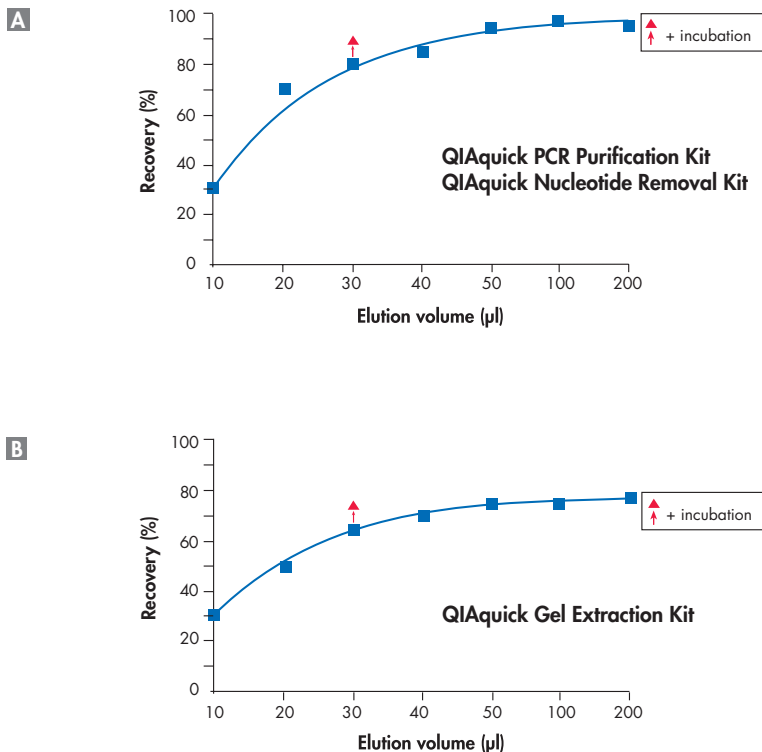

**Figure 4. Highly concentrated DNA.** Effect of elution buffer volume on DNA yield for **A** the QIAquick PCR Purification and QIAquick Nucleotide Removal Kit; **B** the QIAquick Gel Extraction Kit. A 2.9 kb DNA fragment (5 µg) was purified and eluted with the indicated volumes of Buffer EB. 30 µl plus 1 minute incubation on the QIAquick column gives DNA yields similar to 50 µl without incubation, but at a concentration 1.7 times greater.

## Loading Dye

Loading Dye is provided for analysis of purified DNA samples using electrophoresis. It contains 3 marker dyes (bromophenol blue, xylene cyanol, and orange G) that facilitate estimation of DNA migration distance and optimization of agarose gel run time. Refer to Table 2 (page 14) to identify the dyes according to migration distance and agarose gel percentage and type. Loading Dye is supplied as a 5x concentrate; thus 1 volume of Loading Dye should be added to 5 volumes of purified DNA.

**Table 2. Migration distance of gel tracking dyes**

%TAE (TBE) agarose gel	Xylene cyanol (light blue)	Bromophenol blue (dark blue)	Orange G (orange)
0.8	5000 bp (3000 bp)	800 bp (400 bp)	150 bp (<100 bp)
1.0	3000 bp (2000 bp)	400 bp (250 bp)	<100 bp (<100 bp)
1.5	1800 bp (1100 bp)	250 bp (100 bp)	<100 bp (<100 bp)
2.0	1000 bp (600 bp)	200 bp (<100 bp)	<100 bp (<100 bp)
2.5	700 bp (400 bp)	100 bp (<50 bp)	<50 bp (<50 bp)

### Agarose gel analysis of yield

Yields of DNA following cleanup can be determined by agarose gel analysis. Table 3 shows the total yield obtained following extraction of 1 µg or 0.5 µg starting DNA from an agarose gel with a recovery of 80% or 60% using the QIAquick Gel Extraction Kit. The corresponding amount of DNA in a 1 µl aliquot from 50 µl eluate is indicated. Quantities of DNA fragment corresponding to these 1 µl aliquots are shown on the agarose gel in Figure 4.

**Table 3. Amount of DNA in 1 µl aliquots of a 50 µl eluate following QIAquick purification**

Starting DNA	Recovery	Total yield (50 µl eluate)	Amount of DNA in 1 µl
1 µg	80%	0.8 µg	16 ng
	60%	0.6 µg	12 ng
0.5 µg	80%	0.4 µg	8 ng
	60%	0.3 µg	6 ng

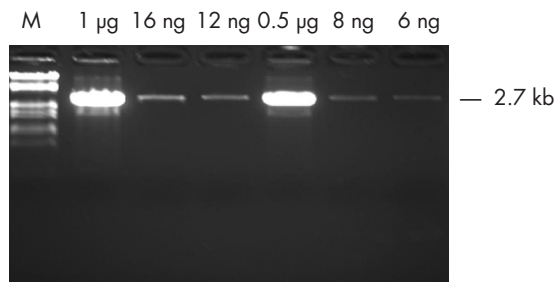
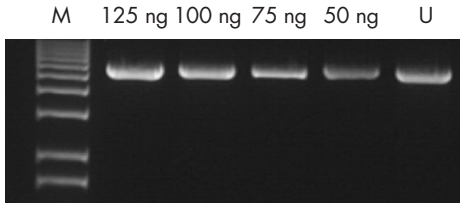

**Figure 5. High DNA recovery.**

Quantities of purified 2.7 kb DNA fragment corresponding to 1/50 of the DNA obtained following purification from 1 µg or 0.5 µg starting DNA with a recovery of 80% or 60% (see Table 1). Samples were run on a 1% TAE agarose gel. **M:** lambda-EcoRI-HindIII markers.

### Quantification of DNA fragments

DNA fragments can be quantified by running a sample alongside standards containing known quantities of the same-sized DNA fragment. The amount of sample DNA loaded can be estimated by visual comparison of the band intensity with that of the standards (Figure 5).



**Figure 6. Agarose gel analysis.** An unknown amount of a 5.5 kb DNA fragment (**U**) was run alongside known quantities (as indicated in ng) of the same DNA fragment. The unknown sample contained 75–100 ng DNA, as estimated by visual comparison with the standards.

**M:** 1 kb DNA ladder.

### Applications using QIAquick purified DNA

DNA purified with QIAquick is suitable for any subsequent application, such as restriction, labeling, hybridization, PCR, ligation and transformation, radioactive and fluorescent sequencing, in vitro transcription, or microinjection.

# The QIAquick Procedure

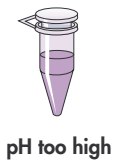
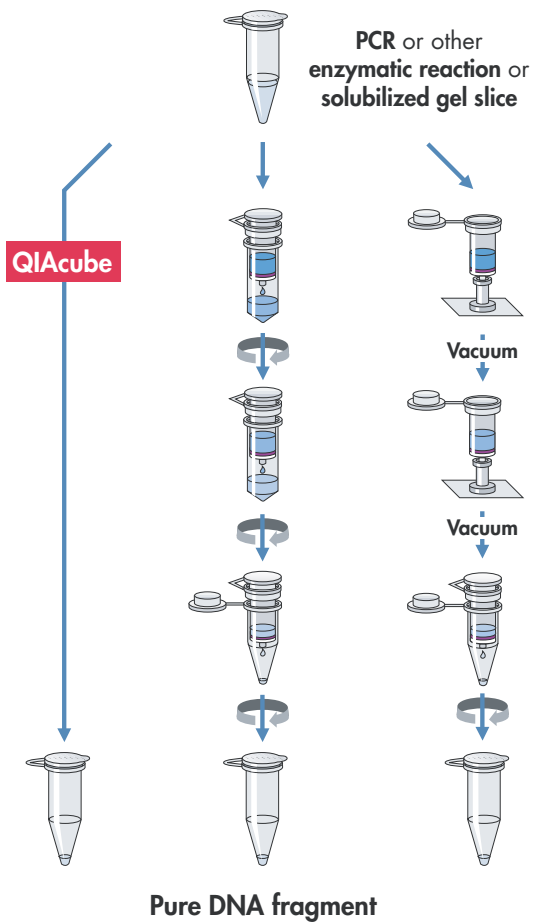



## Equipment and Reagents to Be Supplied by User

When working with chemicals, always wear a suitable lab coat, disposable gloves, and protective goggles. For more information, please consult the appropriate material safety data sheets (MSDSs) available from the product supplier.

### For all protocols

- Ethanol (96–100%)\*
- Microcentrifuge
- 1.5 or 2 ml microcentrifuge tubes
- 3 M sodium acetate, pH 5.0, may be necessary for PCR purification and gel extraction protocols.
- Optional: Distilled water or TE buffer (10 mM Tris-Cl, 1 mM EDTA, pH 8) for elution of DNA.

### Vacuum protocols

- Vacuum manifold (e.g., QIAvac 24 Plus)
- Vacuum pump (e.g., QIAGEN Vacuum Pump, see ordering information).

### Gel extraction protocols

- Isopropanol (100%)
- Heating block or water bath set at 50°C

\* Do not use denaturated alcohol, which contains other substances such as methanol or methylethylketone.

## Protocol: QIAquick PCR Purification Kit using a Microcentrifuge

This protocol is designed to purify single- or double-stranded DNA fragments from PCR and other enzymatic reactions (see page 7). For cleanup of other enzymatic reactions, follow the protocol as described for PCR samples or use the MinElute Reaction Cleanup Kit. Fragments ranging from 100 bp to 10 kb can be purified from primers, nucleotides, polymerases, and salts using QIAquick spin columns in a microcentrifuge.

### Important points before starting

- Add ethanol (96–100%) to Buffer PE before use (see bottle label for volume).
- All centrifugation steps are carried out at  $17,900 \times g$  (13,000 rpm) in a conventional tabletop microcentrifuge at room temperature (15–25°C).
- Add 1:250 volume pH Indicator I to Buffer PB (i.e., add 120  $\mu\text{l}$  pH Indicator I to 30 ml Buffer PB or add 600  $\mu\text{l}$  pH Indicator I to 150 ml Buffer PB). The yellow color of Buffer PB with pH Indicator I indicates a pH of  $\geq 7.5$ .
- Add pH Indicator I to entire buffer contents. Do not add pH Indicator I to buffer aliquots.
- If the purified PCR product is to be used in sensitive microarray applications, it may be beneficial to use Buffer PB without the addition of pH Indicator I.

### Procedure

1. **Add 5 volumes of Buffer PB to 1 volume of the PCR sample and mix. It is not necessary to remove mineral oil or kerosene.**

For example, add 500  $\mu\text{l}$  of Buffer PB to 100  $\mu\text{l}$  PCR sample (not including oil).

2. **If pH Indicator I has been added to Buffer PB, check that the color of the mixture is yellow.**

If the color of the mixture is orange or violet, add 10  $\mu\text{l}$  of 3 M sodium acetate, pH 5.0, and mix. The color of the mixture will turn to yellow.

3. **Place a QIAquick spin column in a provided 2 ml collection tube.**
4. **To bind DNA, apply the sample to the QIAquick column and centrifuge for 30–60 s.**
5. **Discard flow-through. Place the QIAquick column back into the same tube.**

Collection tubes are re-used to reduce plastic waste.

6. **To wash, add 0.75 ml Buffer PE to the QIAquick column and centrifuge for 30–60 s.**
7. **Discard flow-through and place the QIAquick column back in the same tube. Centrifuge the column for an additional 1 min.**

**IMPORTANT:** Residual ethanol from Buffer PE will not be completely removed unless the flow-through is discarded before this additional centrifugation.

8. Place QIAquick column in a clean 1.5 ml microcentrifuge tube.
9. To elute DNA, add 50  $\mu$ l Buffer EB (10 mM Tris-Cl, pH 8.5) or water (pH 7.0–8.5) to the center of the QIAquick membrane and centrifuge the column for 1 min. Alternatively, for increased DNA concentration, add 30  $\mu$ l elution buffer to the center of the QIAquick membrane, let the column stand for 1 min, and then centrifuge.

**IMPORTANT:** Ensure that the elution buffer is dispensed directly onto the QIAquick membrane for complete elution of bound DNA. The average eluate volume is 48  $\mu$ l from 50  $\mu$ l elution buffer volume, and 28  $\mu$ l from 30  $\mu$ l elution buffer.

Elution efficiency is dependent on pH. The maximum elution efficiency is achieved between pH 7.0 and 8.5. When using water, make sure that the pH value is within this range, and store DNA at  $-20^{\circ}\text{C}$  as DNA may degrade in the absence of a buffering agent. The purified DNA can also be eluted in TE buffer (10 mM Tris-Cl, 1 mM EDTA, pH 8.0), but the EDTA may inhibit subsequent enzymatic reactions.

10. If the purified DNA is to be analyzed on a gel, add 1 volume of Loading Dye to 5 volumes of purified DNA. Mix the solution by pipetting up and down before loading the gel.

Loading Dye contains 3 marker dyes (bromophenol blue, xylene cyanol, and orange G) that facilitate estimation of DNA migration distance and optimization of agarose gel run time. Refer to Table 2 (page 14) to identify the dyes according to migration distance and agarose gel percentage and type.

# Protocol: QIAquick PCR Purification Kit using a Vacuum Manifold

QIAquick spin columns can now be used on any vacuum manifold with luer connectors (e.g., QIAvac 24 Plus with Luer Adapters). The following protocol is designed to purify single- or double-stranded DNA fragments from PCR and other enzymatic reactions (see page 7). For cleanup of other enzymatic reactions, follow the protocol as described for PCR samples or use the MinElute Reaction Cleanup Kit. Fragments ranging from 100 bp to 10 kb are purified from primers, nucleotides, polymerases and salts using vacuum-driven sample processing.

## Important points before starting

- Add ethanol (96–100%) to Buffer PE before use (see bottle label for volume).
- Switch off vacuum between steps to ensure that a consistent, even vacuum is applied during manipulations.
- Add 1:250 volume pH Indicator I to Buffer PB (i.e., add 120  $\mu$ l pH Indicator I to 30 ml Buffer PB or add 600  $\mu$ l pH Indicator I to 150 ml Buffer PB). The yellow color of Buffer PB with pH Indicator I indicates a pH of  $\geq 7.5$ .
- Add pH Indicator I to entire buffer contents. Do not add pH Indicator I to buffer aliquots.
- If the purified PCR product is to be used in sensitive microarray applications, it may be beneficial to use Buffer PB without the addition of pH Indicator I.

## Procedure

- 1. Add 5 volumes of Buffer PB to 1 volume of the PCR sample and mix. It is not necessary to remove mineral oil or kerosene.**

For example, add 500  $\mu$ l of Buffer PB to 100  $\mu$ l PCR sample (not including oil).

- 2. If pH Indicator I has been added to Buffer PB, check that the color of the mixture is yellow.**

If the color of the mixture is orange or violet, add 10  $\mu$ l of 3 M sodium acetate, pH 5.0, and mix. The color of the mixture will turn to yellow.

- 3. Prepare the vacuum manifold and QIAquick columns according to step 3a or 3b.**

- 3a. QIAvac 24 Plus (see Figure 7, page 32):**

Insert up to 24 QIAquick spin columns into the luer extensions of the QIAvac 24 Plus. Close unused positions with luer caps and connect QIAvac 24 Plus to a vacuum source.

- 3b. **Other vacuum manifolds:** follow the supplier's instructions. Insert each QIAquick column into a luer connector.
4. **To bind DNA, load the samples into the QIAquick columns by decanting or pipetting, and apply vacuum. After the samples have passed through the column, switch off the vacuum source.**

The maximum loading volume of the column is 800  $\mu$ l. For sample volumes greater than 800  $\mu$ l simply load again.

5. **To wash, add 0.75 ml of Buffer PE to each QIAquick column and apply vacuum.**
6. **Transfer each QIAquick column to a microcentrifuge tube or the provided 2 ml collection tubes. Centrifuge for 1 min at 17,900 x g (13,000 rpm).**

**IMPORTANT:** This spin is necessary to remove residual ethanol (Buffer PE).

7. **Place each QIAquick column into a clean 1.5 ml microcentrifuge tube.**
8. **To elute DNA, add 50  $\mu$ l of Buffer EB (10 mM Tris-Cl, pH 8.5) or water (pH 7.0–8.5) to the center of each QIAquick membrane, and centrifuge the columns for 1 min at 17,900 x g (13,000 rpm). Alternatively, for increased DNA concentration, add 30  $\mu$ l elution buffer to the center of each QIAquick membrane, let the columns stand for 1 min, and then centrifuge.**

**IMPORTANT:** Ensure that the elution buffer is dispensed directly onto the QIAquick membrane for complete elution of bound DNA. The average eluate volume is 48  $\mu$ l from 50  $\mu$ l elution buffer volume, and 28  $\mu$ l from 30  $\mu$ l elution buffer.

Elution efficiency is dependent on pH. The maximum elution efficiency is achieved between pH 7.0 and 8.5. When using water, make sure that the pH value is within this range, and store DNA at  $-20^{\circ}\text{C}$  as DNA may degrade in the absence of a buffering agent. The purified DNA can also be eluted in TE buffer (10 mM Tris-Cl, 1 mM EDTA, pH 8.0), but the EDTA may inhibit subsequent enzymatic reactions.

9. **If the purified DNA is to be analyzed on a gel, add 1 volume of Loading Dye to 5 volumes of purified DNA. Mix the solution by pipetting up and down before loading the gel.**

Loading Dye contains 3 marker dyes (bromophenol blue, xylene cyanol, and orange G) that facilitate estimation of DNA migration distance and optimization of agarose gel run time. Refer to Table 2 (page 14) to identify the dyes according to migration distance and agarose gel percentage and type.

# Protocol: QIAquick Nucleotide Removal Kit using a Microcentrifuge

This protocol is designed for cleanup of radioactive-, biotin-, or DIG-labeled DNA fragments and oligonucleotides  $\geq 17$  nucleotides from enzymatic reactions (see page 7). The protocol ensures removal of primers  $< 10$  bases, enzymes, salts, and unincorporated nucleotides. It is possible to use this kit with a vacuum manifold, as well as with a microcentrifuge, and a protocol for vacuum processing is available on request from QIAGEN Technical Services or your local distributor. However, we do not recommend processing radioactive samples with a vacuum manifold.

## Important points before starting

- Add ethanol (96–100%) to Buffer PE before use (see bottle label for volume).
- All centrifugation steps are in a conventional tabletop microcentrifuge at room temperature (15–25°C).
- Add 100% isopropanol to Buffer PNI before use (see bottle label for volume).

## Procedure

1. **Add 10 volumes of Buffer PNI to 1 volume of the reaction sample and mix.**

For example, add 500  $\mu\text{l}$  Buffer PNI to a 50  $\mu\text{l}$  reaction sample. For DNA fragments  $\geq 100$  bp, only 5 volumes of Buffer PNI are required.

2. **Place a QIAquick spin column in a provided 2 ml collection tube.**
3. **To bind DNA, apply the sample to the QIAquick column and centrifuge for 1 min at 6000 rpm.**
4. **For radioactive samples:**  
**Place the QIAquick column into a clean 2 ml collection tube and discard the tube containing the radioactive flow-through appropriately.**

**For non-radioactive samples:**

**Discard the flow-through and place QIAquick column back into the same tube.**

Collection tubes are reused to reduce plastic waste.

5. **For radioactive samples:**  
**To wash QIAquick column, add 500  $\mu\text{l}$  of Buffer PE and centrifuge for 1 min at 6000 rpm. Discard the flow-through appropriately and repeat wash with another 500  $\mu\text{l}$  of Buffer PE.**

**For non-radioactive samples:**

**To wash QIAquick column, add 750  $\mu\text{l}$  of Buffer PE and centrifuge for 1 min at 6000 rpm.**

6. **Discard the flow-through and place the QIAquick column back in the same tube, which should be empty. Centrifuge for an additional 1 min at 13,000 rpm (17,900 x g).**

**IMPORTANT:** Residual ethanol from Buffer PE will not be completely removed unless the flow-through is discarded before this additional centrifuge.

7. **Place the QIAquick column in a clean 1.5 ml microcentrifuge tube.**
8. **To elute DNA, add 100–200  $\mu$ l of Buffer EB (10 mM Tris-Cl, pH 8.5) or water (pH 7.0–8.5) to the center of the QIAquick membrane and centrifuge the column for 1 min at 13,000 rpm (17,900 x g). Alternatively, for increased DNA concentration, add 30–50  $\mu$ l elution buffer to the center of the QIAquick membrane, let the column stand for 1 min, and then centrifuge.**

**IMPORTANT:** Ensure that the elution buffer is dispensed directly onto the QIAquick membrane for complete elution of bound DNA.

Elution efficiency is dependent on pH. The maximum elution efficiency is achieved between pH 7.0 and 8.5. When using water, make sure that the pH value is within this range, and store DNA at  $-20^{\circ}\text{C}$  as DNA may degrade in the absence of a buffering agent. The purified DNA can also be eluted in TE buffer (10 mM Tris-Cl, 1 mM EDTA, pH 8.0), but the EDTA may inhibit subsequent enzymatic reactions.

9. **If the purified DNA is to be analyzed on a gel, add 1 volume of Loading Dye to 5 volumes of purified DNA. Mix the solution by pipetting up and down before loading the gel.**

Loading Dye contains 3 marker dyes (bromophenol blue, xylene cyanol, and orange G) that facilitate estimation of DNA migration distance and optimization of agarose gel run time. Refer to Table 2 (page 14) to identify the dyes according to migration distance and agarose gel percentage and type.

# Protocol: QIAquick Gel Extraction Kit using a Microcentrifuge

This protocol is designed to extract and purify DNA of 70 bp to 10 kb from standard or low-melt agarose gels in TAE or TBE buffer. Up to 400 mg agarose can be processed per spin column. This kit can also be used for DNA cleanup from enzymatic reactions (see page 7). For DNA cleanup from enzymatic reactions using this protocol, add 3 volumes of Buffer QG and 1 volume of isopropanol to the reaction, mix, and proceed with step 6 of the protocol. Alternatively, use the MinElute Reaction Cleanup Kit.

## Important points before starting

- The yellow color of Buffer QG indicates a pH  $\leq 7.5$ .
- Add ethanol (96–100%) to Buffer PE before use (see bottle label for volume).
- All centrifugation steps are carried out at 17,900  $\times g$  (13,000 rpm) in a conventional table-top microcentrifuge at temperature (15–25°C).

## Procedure

- 1. Excise the DNA fragment from the agarose gel with a clean, sharp scalpel.**  
Minimize the size of the gel slice by removing extra agarose.
- 2. Weigh the gel slice in a colorless tube. Add 3 volumes of Buffer QG to 1 volume of gel (100 mg ~ 100  $\mu$ l).**  
For example, add 300  $\mu$ l of Buffer QG to each 100 mg of gel. For >2% agarose gels, add 6 volumes of Buffer QG. The maximum amount of gel slice per QIAquick column is 400 mg; for gel slices >400 mg use more than one QIAquick column.
- 3. Incubate at 50°C for 10 min (or until the gel slice has completely dissolved). To help dissolve gel, mix by vortexing the tube every 2–3 min during the incubation.**  
**IMPORTANT:** Solubilize agarose completely. For >2% gels, increase incubation time.
- 4. After the gel slice has dissolved completely, check that the color of the mixture is yellow (similar to Buffer QG without dissolved agarose).**  
If the color of the mixture is orange or violet, add 10  $\mu$ l of 3 M sodium acetate, pH 5.0, and mix. The color of the mixture will turn to yellow.  
The adsorption of DNA to the QIAquick membrane is efficient only at pH  $\leq 7.5$ . Buffer QG contains a pH Indicator which is yellow at pH  $\leq 7.5$  and orange or violet at higher pH, allowing easy determination of the optimal pH for DNA binding.
- 5. Add 1 gel volume of isopropanol to the sample and mix.**  
For example, if the agarose gel slice is 100 mg, add 100  $\mu$ l isopropanol. This step increases the yield of DNA fragments <500 bp and >4 kb. For DNA fragments between 500 bp and 4 kb, addition of isopropanol has no effect on yield. Do not centrifuge the sample at this stage.



**6. Place a QIAquick spin column in a provided 2 ml collection tube.**

**7. To bind DNA, apply the sample to the QIAquick column, and centrifuge for 1 min.**

The maximum volume of the column reservoir is 800  $\mu$ l. For sample volumes of more than 800  $\mu$ l, simply load and spin again.

**8. Discard flow-through and place QIAquick column back in the same collection tube.**

Collection tubes are reused to reduce plastic waste.

**9. Recommended: Add 0.5 ml of Buffer QG to QIAquick column and centrifuge for 1 min.**

This step will remove all traces of agarose. It is only required when the DNA will subsequently be used for direct sequencing, in vitro transcription, or microinjection.

**10. To wash, add 0.75 ml of Buffer PE to QIAquick column and centrifuge for 1 min.**

**Note:** If the DNA will be used for salt-sensitive applications, such as blunt-end ligation and direct sequencing, let the column stand 2–5 min after addition of Buffer PE, before centrifuging.

**11. Discard the flow-through and centrifuge the QIAquick column for an additional 1 min at 17,900  $\times$  g (13,000 rpm).**

**IMPORTANT:** Residual ethanol from Buffer PE will not be completely removed unless the flow-through is discarded before this additional centrifugation.

**12. Place QIAquick column into a clean 1.5 ml microcentrifuge tube.**

**13. To elute DNA, add 50  $\mu$ l of Buffer EB (10 mM Tris-Cl, pH 8.5) or water (pH 7.0–8.5) to the center of the QIAquick membrane and centrifuge the column for 1 min. Alternatively, for increased DNA concentration, add 30  $\mu$ l elution buffer to the center of the QIAquick membrane, let the column stand for 1 min, and then centrifuge for 1 min.**

**IMPORTANT:** Ensure that the elution buffer is dispensed directly onto the QIAquick membrane for complete elution of bound DNA. The average eluate volume is 48  $\mu$ l from 50  $\mu$ l elution buffer volume, and 28  $\mu$ l from 30  $\mu$ l.

Elution efficiency is dependent on pH. The maximum elution efficiency is achieved between pH 7.0 and 8.5. When using water, make sure that the pH value is within this range, and store DNA at  $-20^{\circ}\text{C}$  as DNA may degrade in the absence of a buffering agent. The purified DNA can also be eluted in TE buffer (10 mM Tris-Cl, 1 mM EDTA, pH 8.0), but the EDTA may inhibit subsequent enzymatic reactions.

**14. If the purified DNA is to be analyzed on a gel, add 1 volume of Loading Dye to 5 volumes of purified DNA. Mix the solution by pipetting up and down before loading the gel.**

Loading Dye contains 3 marker dyes (bromophenol blue, xylene cyanol, and orange G) that facilitate estimation of DNA migration distance and optimization of agarose gel run time. Refer to Table 2 (page 14) to identify the dyes according to migration distance and agarose gel percentage and type.

# Protocol: QIAquick Gel Extraction Kit using a Vacuum Manifold

QIAquick spin columns can now be used on any vacuum manifold with luer connectors (e.g., QIAvac 24 Plus with Luer Adapters). The following protocol is designed to extract and purify DNA of 70 bp to 10 kb from standard or low-melt agarose gels in TAE or TBE buffer using vacuum-driven processing. Up to 400 mg agarose can be processed per spin column. This kit can also be used for DNA cleanup from enzymatic reactions (see page 7). For DNA cleanup from enzymatic reactions using this protocol, add 3 volumes of Buffer QG and 1 volume of isopropanol to the reaction and mix. Set up the vacuum manifold as described in step 4 and then proceed with step 7 of the protocol. Alternatively, use the new MinElute Reaction Cleanup Kit.

## Important points before starting

- The yellow color of Buffer QG indicates a pH  $\leq 7.5$ .
- Add ethanol (96–100%) to Buffer PE before use (see bottle label for volume).
- Switch off vacuum between steps to ensure that a consistent, even vacuum is applied during manipulations.

## Procedure

- 1. Excise the DNA fragment from the agarose gel with a clean, sharp scalpel.**  
Minimize the size of the gel slice by removing extra agarose.
- 2. Weigh the gel slice in a colorless tube. Add 3 volumes of Buffer QG to 1 volume of gel (100 mg or approximately 100  $\mu$ l).**  
For example, add 300  $\mu$ l of Buffer QG to each 100 mg of gel. For >2% agarose gels, add 6 volumes of Buffer QG. The maximum amount of gel slice per QIAquick column is 400 mg; for gel slices >400 mg use more than one QIAquick column.
- 3. Incubate at 50°C for 10 min (or until the gel slice has completely dissolved). To help dissolve gel, mix by vortexing the tube every 2–3 min during the incubation.**  
**IMPORTANT:** Solubilize agarose completely. For >2% gels, increase incubation time.
- 4. During the incubation, prepare the vacuum manifold and QIAquick columns according to steps 4a or 4b.**
  - 4a. QIAvac 24 Plus (see Figure 7, page 32):**  
Insert up to 24 QIAquick spin columns into the luer extensions of the QIAvac 24 Plus. Close unused positions with luer caps and connect QIAvac 24 Plus to a vacuum source.

- 4b. **Other vacuum manifolds:** Follow the suppliers instructions. Insert each QIAquick-column into a luer connector.
5. **After the gel slice has dissolved completely, check that the color of mixture is yellow (similar to Buffer QG without dissolved agarose).**

**Note:** If the color of the sample is orange or violet, add 10  $\mu$ l of 3 M sodium acetate, pH 5.0, and mix. The color of the mixture will turn to yellow.

The adsorption of DNA to the QIAquick membrane is efficient only at pH  $\leq 7.5$ . Buffer QG contains a pH Indicator that is yellow at pH  $\leq 7.5$  and orange or violet at higher pH, allowing easy determination of the optimal pH for DNA binding.

6. **Add 1 gel volume of isopropanol to the sample and mix by inverting the tube several times.**

For example, if the agarose gel slice is 100 mg, add 100  $\mu$ l isopropanol. This step increases the yield of DNA fragments  $<500$  bp and  $>4$  kb. For DNA fragments between 500 bp and 4 kb, addition of isopropanol has no effect on yield. Do not centrifuge the sample at this stage.

7. **To bind DNA, pipet the sample onto the QIAquick column and apply vacuum. After the sample has passed through the column, switch off vacuum source.**

The maximum volume of the column reservoir is 800  $\mu$ l. For sample volumes of more than 800  $\mu$ l, simply load again.

8. **Recommended: Add 0.5 ml of Buffer QG to QIAquick column and apply vacuum.**

This step will remove all traces of agarose. It is only required when the DNA will subsequently be used for direct sequencing, in vitro transcription, or microinjection.

9. **To wash, add 0.75 ml of Buffer PE to QIAquick column and apply vacuum.**

**Note:** If the DNA will be used for salt-sensitive applications, such as blunt-end ligation and direct sequencing, let the column stand 2–5 min after addition of Buffer PE before applying vacuum.

10. **Transfer QIAquick column to a clean 1.5 ml microcentrifuge tube or to a provided 2 ml collection tube. Centrifuge for 1 min at 17,900 x g (13,000 rpm).**

**IMPORTANT:** This spin is necessary to remove residual ethanol (Buffer PE).

11. **Place QIAquick column in a clean 1.5 ml microcentrifuge tube.**
12. **To elute DNA, add 50  $\mu$ l of Buffer EB (10 mM Tris-Cl, pH 8.5) or water (pH 7–8.5) to the center of the QIAquick membrane and centrifuge the column for 1 min at 17,900 x g (13,000 rpm). Alternatively, for increased DNA concentration, add 30  $\mu$ l elution buffer, let stand for 1 min, and then centrifuge for 1 min.**

**IMPORTANT:** Ensure that the elution buffer is dispensed directly onto the QIAquick membrane for complete elution of bound DNA. The average eluate volume is 48  $\mu$ l from 50  $\mu$ l elution buffer volume, and 28  $\mu$ l from 30  $\mu$ l.

Elution efficiency is dependent on pH. The maximum elution efficiency is achieved between pH 7.0 and 8.5. When using water, make sure that the pH value is within this range, and store DNA at  $-20^{\circ}\text{C}$  as DNA may degrade in the absence of a buffering agent. The purified DNA can also be eluted in TE buffer (10 mM Tris-Cl, 1 mM EDTA, pH 8.0), but the EDTA may inhibit subsequent enzymatic reactions.

13. **If the purified DNA is to be analyzed on a gel, add 1 volume of Loading Dye to 5 volumes of purified DNA. Mix the solution by pipetting up and down before loading the gel.**

Loading Dye contains 3 marker dyes (bromophenol blue, xylene cyanol, and orange G) that facilitate estimation of DNA migration distance and optimization of agarose gel run time. Refer to Table 2 (page 14) to identify the dyes according to migration distance and agarose gel percentage and type.

# Troubleshooting Guide

This troubleshooting guide may be helpful in solving any problems that may arise. For more information, see also the Frequently Asked Questions page at our Technical Support Center: [www.qiagen.com/FAQ/FAQList.aspx](http://www.qiagen.com/FAQ/FAQList.aspx). The scientists in QIAGEN Technical Services are always happy to answer any questions you may have about either the information or protocols in this handbook or sample and assay technologies (for contact information, see back cover or visit [www.qiagen.com](http://www.qiagen.com)).

---

## Comments and Suggestions

---

### Low or no recovery

- |   |   |
|---|---|
| a) Buffer PE did not contain ethanol    | Ethanol must be added to Buffer PE (concentrate) before use. Repeat procedure with correctly prepared Buffer PE.  |
| b) Inappropriate elution buffer         | DNA will only be eluted efficiently in the presence of low-salt buffer (e.g., Buffer EB: 10 mM Tris-Cl, pH 8.5) or water. See "Elution in low-salt solutions", page 12.                           |
| c) Elution buffer incorrectly dispensed | Add elution buffer to the center of the QIAquick membrane to ensure that the buffer completely covers the membrane. This is particularly important when using small elution volumes (30 $\mu$ l). |

### QIAquick Gel Extraction Kit only

- |   |  |
|---|--|
| d) Gel slice incompletely solubilized   | After addition of Buffer QG to the gel slice, mix by vortexing the tube every 2–3 min during the 50°C incubation. DNA will remain in any undissolved agarose.  |
| e) pH of electrophoresis buffer too high (binding mixture turns orange or violet) | The electrophoresis buffer has been repeatedly used or incorrectly prepared, resulting in a sample pH that exceeds the buffering capacity of Buffer QG and leads to inefficient DNA binding. Add 10 $\mu$ l of 3 M sodium acetate, pH 5.0, to the sample and mix. The color of the mixture will turn yellow indicating the correct pH for DNA binding. Even for binding mixtures with only small color changes (slight orange color), add the 10 $\mu$ l sodium acetate. |
| f) Gel slice was too large (>400 mg)  | 70–80% recovery can only be obtained from $\leq$ 400 mg gel slice per QIAquick column. For gel slices >400 mg, use multiple QIAquick columns.  |

### QIAquick PCR Purification Kit only

- |                                |  |
|--------------------------------|--|
| g) Insufficient/no PCR product | Estimate DNA recovery by running 10% of PCR product before and after purification on an agarose gel. |
|--------------------------------|--|

---

## Comments and Suggestions

---

### ***QIAquick Gel Extraction Kit and QIAquick PCR Purification Kit only***

- h) Cloudy and gelatinous appearance of sample mixture after addition of isopropanol      This may be due to salt precipitation, and will disappear upon mixing the sample. Alternatively, the gel slice may not be completely solubilized. In this case, apply the mixture to the QIAquick column, centrifuge, and then add 0.5 ml Buffer QG to the column. Let stand for 1 min at room temperature (15–25°C), and then centrifuge and continue with the procedure. This additional wash will solubilize remaining agarose.
- i) Binding mixture turns orange or violet      The pH in the sample exceeds the buffer capacity of Buffer QG or PB respectively. Add 20 µl of 3 M sodium acetate, pH 5.0, to the sample and mix. The color of the mixture will turn yellow indicating the correct pH for DNA binding. Even for samples with slight color changes (orange color), add 10 µl sodium acetate.

### **DNA does not perform well (e.g., in ligation reactions)**

- a) Salt concentration in eluate too high      Modify the wash step by incubating the column for 5 min at room temperature after adding 750 µl of Buffer PE, then centrifuge.
- b) Eluate contains residual ethanol      Ensure that the wash flow-through is drained from the collection tube and that the QIAquick column is then centrifuged at 17,900 × *g* (13,000 rpm) for an additional 1 min.

### ***QIAquick Gel Extraction Kit only***

- c) Eluate contaminated with agarose      The gel slice is incompletely solubilized or weighs >400 mg. Repeat procedure, including the optional Buffer QG column-wash step.

### ***QIAquick PCR Purification Kit only***

- d) Eluate contains primer dimers      Primer-dimers formed are >20 bp and are not completely removed. After the binding step, wash the QIAquick column with 750 µl of a 35% guanidine hydrochloride aqueous solution (35 g in 100 ml). Continue with the Buffer PE wash step and the elution step as in the protocol.

## Comments and Suggestions

---

- e) Eluate contains denatured ssDNA, which appears as smaller smeared band on an analytical gel
- Use the eluted DNA to prepare the subsequent enzymatic reaction but omit the enzyme. To reanneal the ssDNA, incubate the reaction mixture at 95°C for 2 min, and allow the tube to cool slowly to room temperature. Add the enzyme and proceed as usual. Alternatively, the DNA can be eluted in 10 mM Tris buffer containing 10 mM NaCl. The salt and buffering agent promote the renaturation of DNA strands. However, the salt concentration of the eluate must then be considered for subsequent applications.

# Appendix: QIAvac Vacuum Manifolds

## Handling guidelines for QIAvac 24 Plus

- Always place the QIAvac 24 Plus on a secure bench top or work area. If dropped, the QIAvac 24 Plus manifold may crack.
- Always store the QIAvac 24 Plus clean and dry. For cleaning procedures see the *QIAvac 24 Plus Handbook*.
- The components of the QIAvac 24 Plus are not resistant to certain solvents (Table 4). If these solvents are spilled on the unit, rinse it thoroughly with water.
- To ensure consistent performance, do not apply silicone or vacuum grease to any part of the QIAvac 24 Plus manifold.
- Always use caution and wear safety glasses when working near a vacuum manifold under pressure.
- Contact QIAGEN Technical Services or your local distributor for information concerning spare or replacement parts.

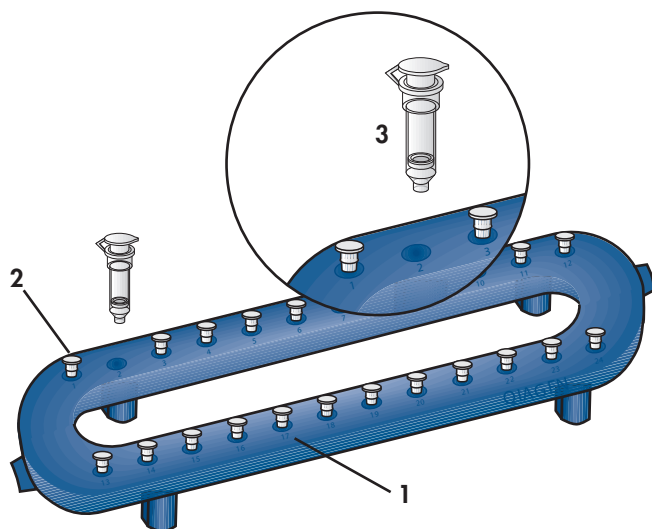

**Figure 7. QIAvac 24 Plus.** Setting up the QIAvac 24 Plus with QIAprep<sup>®</sup>, QIAquick, MinElute, or RNeasy<sup>®</sup> Mini Spin Columns.

1. QIAvac 24 Plus vacuum manifold
2. Luer slot closed with luer plug
3. Spin column\*

\* Not included with the QIAvac 24 Plus. Included in appropriate purification kits.



**Table 4. Chemical resistance properties of the QIAvac 24 Plus**

<b>Resistant to:</b>		
Acetic acid	Chaotropic salts	Chlorine bleach
Chromic acid	Hydrochloric acid	SDS
Sodium chloride	Sodium hydroxide	Tween 20
Urea		
<b>Not resistant to:</b>		
Benzene	Chloroform	Ethers
Phenol	Toluene	

## References

1. Vogelstein, B. and Gillespie, D. (1979) Preparative and analytical purification of DNA from agarose. *Proc. Natl. Acad. Sci. USA* **76**, 615.
2. Hamaguchi, K. and Geiduschek, E.P. (1962) The effect of electrolytes on the stability of deoxyribonucleate helix. *J. Am. Chem. Soc.* **84**, 1329.

# Ordering Information

Product	Contents	Cat. no.
QIAquick PCR Purification Kit (50)	50 QIAquick Spin Columns, Buffers, Collection Tubes (2 ml)	28104
QIAquick PCR Purification Kit (250)	250 QIAquick Spin Columns, Buffers, Collection Tubes (2 ml)	28106
QIAquick Nucleotide Removal Kit (50)	50 QIAquick Spin Columns, Buffers, Collection Tubes (2 ml)	28304
QIAquick Nucleotide Removal Kit (250)	250 QIAquick Spin Columns, Buffers, Collection Tubes (2 ml)	28306
QIAquick Gel Extraction Kit (50)	50 QIAquick Spin Columns, Buffers, Collection Tubes (2 ml)	28704
QIAquick Gel Extraction Kit (250)	250 QIAquick Spin Columns, Buffers, Collection Tubes (2 ml)	28706
<b>Related products</b>		
MinElute Reaction Cleanup Kit (50)	50 MinElute Spin Columns, Buffers, Collection Tubes (2 ml)	28204
MinElute Reaction Cleanup Kit (250)	250 MinElute Spin Columns, Buffers, Collection Tubes (2 ml)	28206
MinElute Gel Extraction Kit (50)	50 MinElute Spin Columns, Buffers, Collection Tubes (2 ml)	28604
MinElute Gel Extraction Kit (250)	250 MinElute Spin Columns, Buffers, Collection Tubes (2 ml)	28606
MinElute PCR Purification Kit (50)	50 MinElute Spin Columns, Buffers, Collection Tubes (2 ml)	28004
MinElute PCR Purification Kit (250)	250 MinElute Spin Columns, Buffers, Collection Tubes (2 ml)	28006
<b>Individual buffers</b>		
Buffer PB (500 ml)	500 ml Binding Buffer	19066
Buffer PE (concentrate)	100 ml Buffer PE (5x concentrate; final volume 500 ml)	19065
Buffer QG* (250 ml)	250 ml Solubilization and Binding Buffer (with pH Indicator)	19063

\* Additional Buffer QG may be required for routine purifications from gel slices >300 mg from gels containing >2% agarose.

# Ordering Information

Product	Contents	Cat. no.
<b>QIAcube and accessories</b>		
QIAcube*	Robotic workstation for automated purification of DNA, RNA, or proteins using QIAGEN spin-column kits, 3-year warranty on parts and labor	9001292 <sup>†</sup> 9001293 <sup>‡</sup>
Starter Pack, QIAcube <sup>§</sup>	Pack includes: reagent bottle racks (3); rack labeling strips (8); 200 µl filter-tips (1024); 1000 µl filter-tips (2048); 30 ml reagent bottles (18); rotor adapters (240); rotor adapter holder; 1.5 ml elution tubes (240)	990395
<b>QIAvac manifolds and accessories</b>		
QIAvac 24 Plus	Vacuum manifold for processing 1–24 spin columns: includes QIAvac 24 Plus Vacuum Manifold, Luer Plugs, Quick Couplings	19413
QIAvac 96	Vacuum manifold for processing QIAGEN 96 well-plates: includes QIAvac 96 Top plate, Base, Waste Tray, Plate Holder	19504
Vacuum Regulator	For use with QIAvac manifolds	19530
Vacuum Pump	Universal vacuum pump (capacity 34 L/min, 8 mbar vacuum abs.)	84000 <sup>¶</sup> 84010 <sup>**</sup> 84020 <sup>††</sup>

For up-to-date licensing information and product-specific disclaimers, see the respective QIAGEN kit handbook or user manual. QIAGEN kit handbooks and user manuals are available at [www.qiagen.com](http://www.qiagen.com) or can be requested from QIAGEN Technical Services or your local distributor.

\* Agreements for comprehensive service coverage are available; please inquire.

<sup>†</sup> US, Canada, and Japan.

<sup>‡</sup> Rest of world.

<sup>§</sup> All starter pack items are available separately.

<sup>¶</sup> Japan.

<sup>\*\*</sup> US and Canada.

<sup>††</sup> Rest of world.

**Notes**

## Notes

**Trademarks:**

QIAGEN®, QIAquick®, QIAprep®, MinElute®, QIAcube®, RNeasy® (QIAGEN Group); Tween® (ICI Americas Inc.).

**Limited License Agreement for QIAquick PCR Purification, QIAquick Nucleotide Removal, and QIAquick Gel Extraction Kits**

Use of this product signifies the agreement of any purchaser or user of the product to the following terms:

1. The product may be used solely in accordance with the protocols provided with the product and this handbook and for use with components contained in the kit only. QIAGEN grants no license under any of its intellectual property to use or incorporate the enclosed components of this kit with any components not included within this kit except as described in the protocols provided with the product, this handbook, and additional protocols available at [www.qiagen.com](http://www.qiagen.com). Some of these additional protocols have been provided by QIAGEN users for QIAGEN users. These protocols have not been thoroughly tested or optimized by QIAGEN. QIAGEN neither guarantees them nor warrants that they do not infringe the rights of third-parties.
2. Other than expressly stated licenses, QIAGEN makes no warranty that this kit and/or its use(s) do not infringe the rights of third-parties.
3. This kit and its components are licensed for one-time use and may not be reused, refurbished, or resold.
4. QIAGEN specifically disclaims any other licenses, expressed or implied other than those expressly stated.
5. The purchaser and user of the kit agree not to take or permit anyone else to take any steps that could lead to or facilitate any acts prohibited above. QIAGEN may enforce the prohibitions of this Limited License Agreement in any Court, and shall recover all its investigative and Court costs, including attorney fees, in any action to enforce this Limited License Agreement or any of its intellectual property rights relating to the kit and/or its components.

For updated license terms, [see www.qiagen.com](http://www.qiagen.com).

© 2007–2012 QIAGEN, all rights reserved.

**www.qiagen.com**

**Australia** = techservice-au@qiagen.com

**Austria** = techservice-at@qiagen.com

**Belgium** = techservice-bnl@qiagen.com

**Brazil** = suportetecnico.brasil@qiagen.com

**Canada** = techservice-ca@qiagen.com

**China** = techservice-cn@qiagen.com

**Denmark** = techservice-nordic@qiagen.com

**Finland** = techservice-nordic@qiagen.com

**France** = techservice-fr@qiagen.com

**Germany** = techservice-de@qiagen.com

**Hong Kong** = techservice-hk@qiagen.com

**India** = techservice-india@qiagen.com

**Ireland** = techservice-uk@qiagen.com

**Italy** = techservice-it@qiagen.com

**Japan** = techservice-jp@qiagen.com

**Korea (South)** = techservice-kr@qiagen.com

**Luxembourg** = techservice-bnl@qiagen.com

**Mexico** = techservice-mx@qiagen.com

**The Netherlands** = techservice-bnl@qiagen.com

**Norway** = techservice-nordic@qiagen.com

**Singapore** = techservice-sg@qiagen.com

**Sweden** = techservice-nordic@qiagen.com

**Switzerland** = techservice-ch@qiagen.com

**UK** = techservice-uk@qiagen.com

**USA** = techservice-us@qiagen.com

