

PRODUCT INFORMATION & MANUAL

Mouse IFN-gamma Platinum ELISA

BMS609 / BMS609TEN

Enzyme-linked Immunosorbent Assay for
quantitative detection of mouse IFN-gamma.

For research use only.

Not for diagnostic or therapeutic procedures.



*Mouse IFN-gamma
Platinum ELISA
Extra sensitive*

North America

Technical Support:

Research Products:
888.810.6168
858.642.2058
tech@eBioscience.com

Clinical Products:
877.726.8559
858.642.2058
tech@eBioscience.com

Customer Service:

888.999.1371
858.642.2058
info@eBioscience.com

Fax:

858.642.2046

Europe/International*

Technical Support:

+43 1 796 40 40-120
tech@eBioscience.com

Customer Service:

+43 1 796 40 40-304
info@eBioscience.com

Fax:

+43 1 796 40 40-400



Bender MedSystems GmbH
Campus Vienna Biocenter 2
1030 Vienna, Austria
www.eBioscience.com

* Customers outside North America and Europe may contact their eBioscience distributor listed on our website at www.eBioscience.com/distributors.

TABLE OF CONTENTS

1	Intended Use	3
2	Summary	3
3	Principles of the Test	5
4	Reagents Provided	7
5	Storage Instructions – ELISA Kit	9
6	Specimen Collection and Storage Instructions	9
7	Materials Required But Not Provided	10
8	Precautions for Use	11
9	Preparation of Reagents	13
10	Test Protocol	19
11	Calculation of Results	24
12	Limitations	27
13	Performance Characteristics	28
14	Ordering Information	33
15	Reagent Preparation Summary	34
16	Test Protocol Summary	35

1 Intended Use

The mouse IFN-gamma ELISA (extra sensitive) is an enzyme-linked immunosorbent assay for the quantitative detection of mouse IFN-gamma. **The mouse IFN-gamma ELISA (extra sensitive) is for research use only. Not for diagnostic or therapeutic procedures.**

2 Summary

IFN-gamma, also called Type II interferon, is a homodimeric glycoprotein containing approximately 21 to 24 kD subunits.

In contrast to IFN α and IFN β synthesis, which can occur in any cell, production of IFN-gamma is a function of T cells and NK cells. All IFN-gamma inducers activate T cells either in a polyclonal (mitogens or antibodies) or in a clonally restricted, antigen-specific, manner. IFN-gamma is produced during infection by T cells of the cytotoxic/suppressor phenotype (CD8) and by a subtype of helper T cells, the Th1 cells. Th1 cells secrete IL-2, IL-3, TNF β and IFN-gamma, whereas Th2 cells mainly produce IL-3, IL-4, IL-5 and IL-10, but little or no IFN-gamma. IFN-gamma preferentially inhibits the proliferation of Th2 but not Th1 cells, indicating that the presence of IFN-gamma during an immune response will result in the preferential proliferation of Th1 cells.

Type II IFN or IFN-gamma is a lymphokine that displays no molecular homology with type I IFN, but shares some important biologic activities. Specifically, IFN-gamma induces an anti-viral state and is anti-proliferative. In addition, IFN-gamma has several properties related to immunoregulation

- (1) IFN-gamma is a potent activator of mononuclear phagocytes, e.g. IFN-gamma stimulates the expression of Mac-1, augments endocytosis and phagocytosis by monocytes; and activates macrophages to kill tumor cells by releasing reactive oxygen intermediates and TNF α (9).
- (2) IFN-gamma induces or augments the expression of MHC antigens on macrophages, T and B cells and some tumor cell lines.

- (3) On T and B cells IFN-gamma promotes differentiation. It enhances proliferation of activated B cells and can act synergistically with IL-2 to increase immunoglobulin light-chain synthesis. IFN-gamma is one of the natural B-cell differentiation factors.
- (4) Finally, IFN-gamma activates neutrophils, NK cells and vascular endothelial cells.

The role of IFN-gamma as a disease marker has been demonstrated for a number of different pathological situations.

For literature update refer to **www.eBioscience.com**

3 Principles of the Test

An anti-mouse IFN-gamma coating antibody is adsorbed onto microwells.

Mouse IFN-gamma present in the sample or standard binds to antibodies adsorbed to the microwells and a biotin-conjugated anti-mouse IFN-gamma antibody is added and binds to mouse IFN-gamma captured by the first antibody.

Following incubation unbound biotin-conjugated anti-mouse IFN-gamma antibody is removed during a wash step Streptavidin-HRP is added and binds to the biotin-conjugated anti-mouse IFN-gamma antibody.

Following incubation unbound Streptavidin-HRP is removed during a wash step, and substrate solution reactive with HRP is added to the wells.

Figure 1

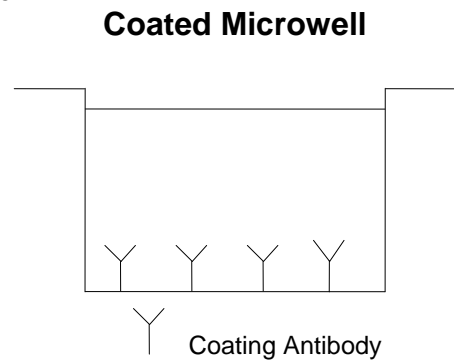

Figure 2

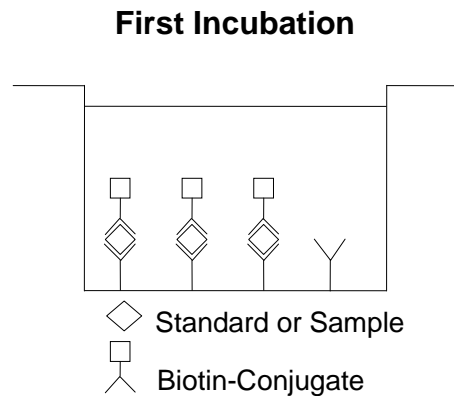

Figure 3

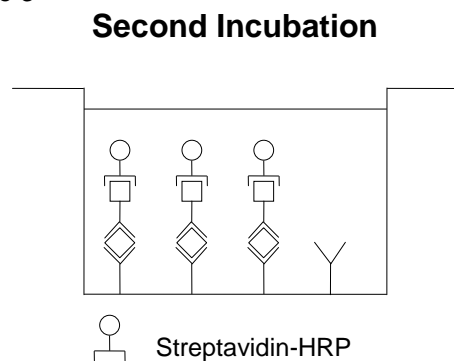
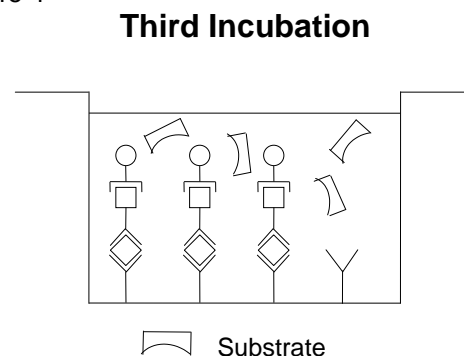
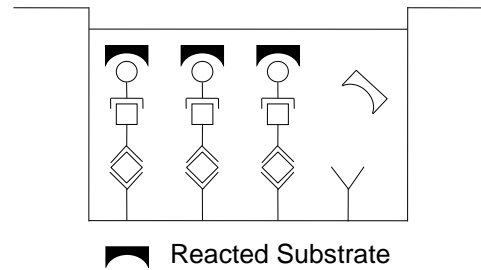

Figure 4



A coloured product is formed in proportion to the amount of mouse IFN-gamma present in the sample or standard. The reaction is terminated by addition of acid and absorbance is measured at 450 nm. A standard curve is prepared from 7 mouse IFN-gamma standard dilutions and mouse IFN-gamma sample concentration determined.

Figure 5

Fourth Incubation

4 Reagents Provided

4.1 Reagents for mouse IFN-gamma ELISA (extra sensitive) BMS609 (96 tests)

- 1 aluminium pouch with a **Microwell Plate coated** with monoclonal antibody to mouse IFN-gamma
- 1 vial (70 µl) **Biotin-Conjugate** anti-mouse IFN-gamma monoclonal antibody
- 1 vial (150 µl) **Streptavidin-HRP**
- 2 vials mouse IFN-gamma **Standard** lyophilized, 80 pg/ml upon reconstitution
- 2 vials (12 ml) **Sample Diluent**

(Please note: In some cases the Sample Diluent contains an insoluble precipitate which does not interfere in any way with the test performance. Use according to protocol.)

- 1 bottle (5 ml) **Calibrator Diluent**
- 1 vial (5 ml) **Assay Buffer Concentrate** 20x
(PBS with 1% Tween 20 and 10% BSA)
- 1 bottle (50 ml) **Wash Buffer Concentrate** 20x
(PBS with 1% Tween 20)
- 1 vial (15 ml) **Substrate Solution** (tetramethyl-benzidine)
- 1 vial (15 ml) **Stop Solution** (1M Phosphoric acid)
- 1 vial (0.4 ml) **Blue-Dye**
- 1 vial (0.4 ml) **Green-Dye**
- 1 vial (0.4 ml) **Red-Dye**
- 4 **Adhesive Films**

4.2 Reagents for mouse IFN-gamma ELISA (extra sensitive)

BMS609TEN (10x96 tests)

10 aluminium pouches with a **Microwell Plate coated** with monoclonal antibody to mouse IFN-gamma

10 vials (70 µl) **Biotin-Conjugate** anti-mouse IFN-gamma monoclonal antibody

10 vials (150 µl) **Streptavidin-HRP**

10 vials mouse IFN-gamma **Standard** lyophilized, 80 pg/ml upon reconstitution

12 vials (12 ml) **Sample Diluent**

(Please note: In some cases the Sample Diluent contains an insoluble precipitate which does not interfere in any way with the test performance. Use according to protocol.)

5 bottles (5 ml) **Calibrator Diluent**

6 vials (5 ml) **Assay Buffer Concentrate 20x**
(PBS with 1% Tween 20 and 10% BSA)

6 bottles (50 ml) **Wash Buffer Concentrate 20x**
(PBS with 1% Tween 20)

10 vials (15 ml) **Substrate Solution** (tetramethyl-benzidine)

10 vials (15 ml) **Stop Solution** (1M Phosphoric acid)

6 vials (0.4 ml) **Blue-Dye**

6 vials (0.4 ml) **Green-Dye**

6 vials (0.4 ml) **Red-Dye**

20 **Adhesive Films**

5 Storage Instructions – ELISA Kit

Store kit reagents between 2°C and 8°C. Immediately after use remaining reagents should be returned to cold storage (2°C to 8°C). Expiry of the kit and reagents is stated on labels.

Expiry of the kit components can only be guaranteed if the components are stored properly, and if, in case of repeated use of one component, this reagent is not contaminated by the first handling.

6 Specimen Collection and Storage Instructions

Cell culture supernatant, serum and plasma (EDTA, citrate) were tested with this assay. Other biological samples might be suitable for use in the assay. Remove serum or plasma from the clot or cells as soon as possible after clotting and separation.

Samples containing a visible precipitate must be clarified prior to use in the assay. Do not use grossly hemolyzed or lipemic specimens.

Samples should be aliquoted and must be stored frozen at -20°C to avoid loss of bioactive mouse IFN-gamma. If samples are to be run within 24 hours, they may be stored at 2° to 8°C (for stability refer to 13.5).

Avoid repeated freeze-thaw cycles. Prior to assay, the frozen sample should be brought to room temperature slowly and mixed gently.

7 Materials Required But Not Provided

- 5 ml and 10 ml graduated pipettes
- 5 μ l to 1000 μ l adjustable single channel micropipettes with disposable tips
- 50 μ l to 300 μ l adjustable multichannel micropipette with disposable tips
- Multichannel micropipette reservoir
- Beakers, flasks, cylinders necessary for preparation of reagents
- Device for delivery of wash solution (multichannel wash bottle or automatic wash system)
- Microplate shaker
- Microwell strip reader capable of reading at 450 nm (620 nm as optional reference wave length)
- Glass-distilled or deionized water
- Statistical calculator with program to perform regression analysis

8 Precautions for Use

- All reagents should be considered as potentially hazardous. We therefore recommend that this product is handled only by those persons who have been trained in laboratory techniques and that it is used in accordance with the principles of good laboratory practice. Wear suitable protective clothing such as laboratory overalls, safety glasses and gloves. Care should be taken to avoid contact with skin or eyes. In the case of contact with skin or eyes wash immediately with water. See material safety data sheet(s) and/or safety statement(s) for specific advice.
- Reagents are intended for research use only and are not for use in diagnostic or therapeutic procedures.
- Do not mix or substitute reagents with those from other lots or other sources.
- Do not use kit reagents beyond expiration date on label.
- Do not expose kit reagents to strong light during storage or incubation.
- Do not pipette by mouth.
- Do not eat or smoke in areas where kit reagents or samples are handled.
- Avoid contact of skin or mucous membranes with kit reagents or specimens.
- Rubber or disposable latex gloves should be worn while handling kit reagents or specimens.
- Avoid contact of substrate solution with oxidizing agents and metal.
- Avoid splashing or generation of aerosols.
- In order to avoid microbial contamination or cross-contamination of reagents or specimens which may invalidate the test use disposable pipette tips and/or pipettes.
- Use clean, dedicated reagent trays for dispensing the conjugate and substrate reagent.

- Exposure to acid inactivates the conjugate.
- Glass-distilled water or deionized water must be used for reagent preparation.
- Substrate solution must be at room temperature prior to use.
- Decontaminate and dispose specimens and all potentially contaminated materials as they could contain infectious agents. The preferred method of decontamination is autoclaving for a minimum of 1 hour at 121.5°C.
- Liquid wastes not containing acid and neutralized waste may be mixed with sodium hypochlorite in volumes such that the final mixture contains 1.0% sodium hypochlorite. Allow 30 minutes for effective decontamination. Liquid waste containing acid must be neutralized prior to the addition of sodium hypochlorite.

9 Preparation of Reagents

Buffer Concentrates should be brought to room temperature and should be diluted before starting the test procedure.

If crystals have formed in the **Buffer Concentrates**, warm them gently until they have completely dissolved.

9.1 Wash Buffer (1x)

Pour entire contents (50 ml) of the **Wash Buffer Concentrate** (20x) into a clean 1000 ml graduated cylinder. Bring to final volume of 1000 ml with glass-distilled or deionized water. Mix gently to avoid foaming.

Transfer to a clean wash bottle and store at 2° to 25°C. Please note that Wash Buffer (1x) is stable for 30 days.

Wash Buffer (1x) may also be prepared as needed according to the following table:

Number of Strips	Wash Buffer Concentrate (20x) (ml)	Distilled Water (ml)
1 - 6	25	475
1 - 12	50	950

9.2 Assay Buffer (1x)

Pour the entire contents (5 ml) of the **Assay Buffer Concentrate** (20x) into a clean 100 ml graduated cylinder. Bring to final volume of 100 ml with distilled water. Mix gently to avoid foaming.

Store at 2° to 8°C. Please note that the Assay Buffer (1x) is stable for 30 days.

Assay Buffer (1x) may also be prepared as needed according to the following table:

Number of Strips	Assay Buffer Concentrate (20x) (ml)	Distilled Water (ml)
1 - 6	2.5	47.5
1 - 12	5.0	95.0

9.3 Biotin-Conjugate

Please note that the Biotin-Conjugate should be used within 30 minutes after dilution.

Make a 1:100 dilution of the concentrated **Biotin-Conjugate** solution with **Sample Diluent** in a clean plastic tube as needed according to the following table:

Number of Strips	Biotin-Conjugate (ml)	Sample Diluent (ml)
1 - 6	0.03	2.97
1 - 12	0.06	5.94

9.4 Streptavidin-HRP

Please note that the Streptavidin-HRP should be used within 30 minutes after dilution.

Make a 1:100 dilution of the concentrated **Streptavidin-HRP** solution with **Assay Buffer (1x)** in a clean plastic tube as needed according to the following table:

Number of Strips	Streptavidin-HRP (ml)	Assay Buffer (1x) (ml)
1 - 6	0.06	5.94
1 - 12	0.12	11.88

9.5 Mouse IFN-gamma Standard

Reconstitute **mouse IFN-gamma standard** by addition of **Calibrator Diluent**.

Reconstitution volume is stated on the label of the standard vial. Swirl or mix gently to insure complete and homogeneous solubilization (concentration of reconstituted standard = 80 pg/ml).

Allow the standard to reconstitute for 10-30 minutes. Mix well prior to making dilutions.

The standard has to be used immediately after reconstitution and cannot be stored.

Standard dilutions can be prepared directly on the microwell plate (see 10.d) or alternatively in tubes (see 9.5.1).

9.5.1 External Standard Dilution

Label 7 tubes, one for each standard point.

S1, S2, S3, S4, S5, S6, S7

Then prepare 2-fold serial dilutions for the standard curve as follows:

Pipette 225 µl of Calibrator Diluent into each tube.

Pipette 225 µl of reconstituted standard (concentration = 80 pg/ml) into the first tube, labelled S1, and mix (concentration of S1 = 40 pg/ml).

Pipette 225 µl of this dilution into the second tube, labelled S2, and mix thoroughly before the next transfer.

Repeat serial dilutions 5 more times thus creating the points of the standard curve (see Figure 6).

Calibrator Diluent serves as blank.

Figure 6

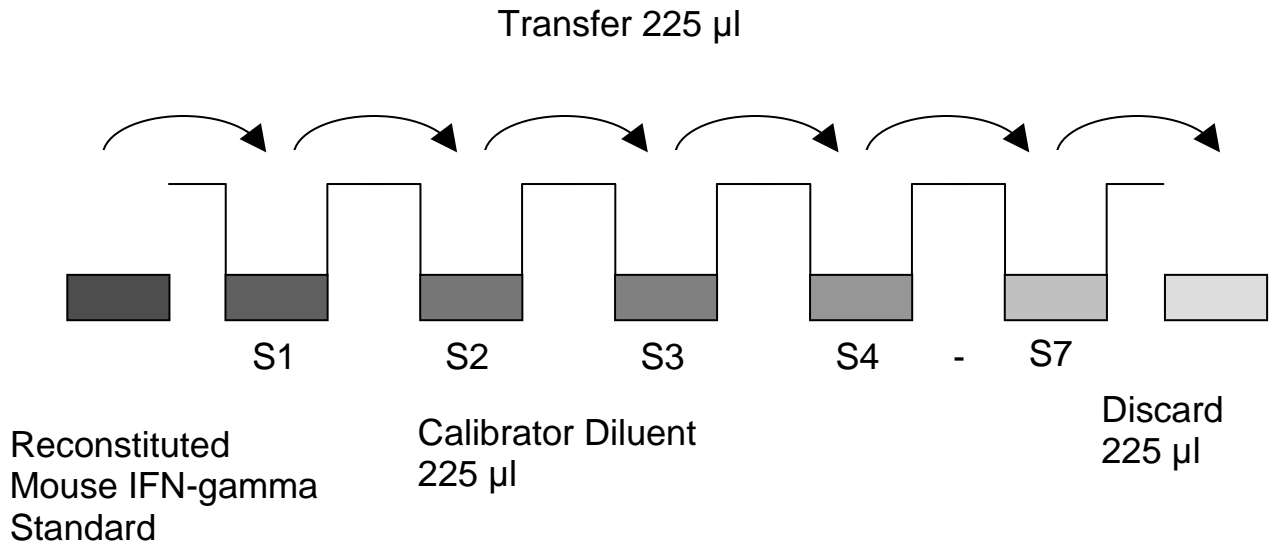

9.6 Addition of Colour-giving Reagents: Blue-Dye, Green-Dye, Red-Dye

In order to help our customers to avoid any mistakes in pipetting the eBioscience ELISAs, eBioscience offers a tool that helps to monitor the addition of even very small volumes of a solution to the reaction well by giving distinctive colours to each step of the ELISA procedure.

This procedure is optional, does not in any way interfere with the test results, and is designed to help the customer with the performance of the test, but can also be omitted, just following the instruction booklet.

Alternatively, the dye solutions from the stocks provided (**Blue-Dye, Green-Dye, Red-Dye**) can be added to the reagents according to the following guidelines:

1. Diluent:

Before standard and sample dilution add the **Blue-Dye** at a dilution of 1:250 (see table below) to the appropriate diluent (1x) according to the test protocol. After addition of **Blue-Dye**, proceed according to the instruction booklet.

5 ml Calibrator Diluent	20 µl Blue-Dye
12 ml Calibrator Diluent	48 µl Blue-Dye
50 ml Calibrator Diluent	200 µl Blue-Dye

2. Biotin Conjugate

Before dilution of the concentrated Biotin-Conjugate, add the **Green-Dye** at a dilution of 1:100 (see table below) to the Sample Diluent used for the final conjugate dilution. Proceed after addition of **Green-Dye** according to the instruction booklet: Preparation of Biotin-Conjugate Mixture.

3 ml Sample Diluent	30 µl Green-Dye
6 ml Sample Diluent	60 µl Green-Dye

3. Streptavidin-HRP:

Before dilution of the concentrated Streptavidin-HRP, add the **Red-Dye** at a dilution

of 1:250 (see table below) to the Assay Buffer (1x) used for the final Streptavidin-HRP dilution. Proceed after addition of **Red-Dye** according to the instruction booklet: Preparation of Streptavidin-HRP.

6 ml Assay Buffer (1x)	24 μ l Red-Dye
12 ml Assay Buffer (1x)	48 μ l Red-Dye

10 Test Protocol

- a. Determine the number of microwell strips required to test the desired number of samples plus appropriate number of wells needed for running blanks and standards. Each sample, standard, blank and optional control sample should be assayed in duplicate. Remove extra microwell strips from holder and store in foil bag with the desiccant provided at 2°-8°C sealed tightly.
- b. Prepare **Biotin-Conjugate** (see Preparation of Biotin-Conjugate 9.3).
- c. Wash the microwell strips twice with approximately 400 µl **Wash Buffer** per well with thorough aspiration of microwell contents between washes. Allow the Wash Buffer to sit in the wells for about **10 – 15 seconds** before aspiration. Take care not to scratch the surface of the microwells.
After the last wash step, empty wells and tap microwell strips on absorbent pad or paper towel to remove excess Wash Buffer. Use the microwell strips immediately after washing. Alternatively microwell strips can be placed upside down on a wet absorbent paper for not longer than 15 minutes. **Do not allow wells to dry.**
- d. **Standard dilution on the microwell plate** (Alternatively the standard dilution can be prepared in tubes – see 9.5.1):
Add 100 µl of Calibrator Diluent in duplicate to all **standard wells**. Pipette 100 µl of prepared **standard** (see Preparation of Standard 9.5, concentration = 80 pg/ml), in duplicate, into well A1 and A2 (see Table 1). Mix the contents of wells A1 and A2 by repeated aspiration and ejection (concentration of standard 1 S1 = 40 pg/ml), and transfer 100 µl to wells B1 and B2, respectively (see Figure 7). Take care not to scratch the inner surface of the microwells. Continue this procedure 5 times, creating two rows of mouse IFN-gamma standard dilutions, ranging from 40.00 pg/ml to 0.63 pg/ml. Discard 100 µl of the contents from the last microwells (G1/G2) used.

Figure 7

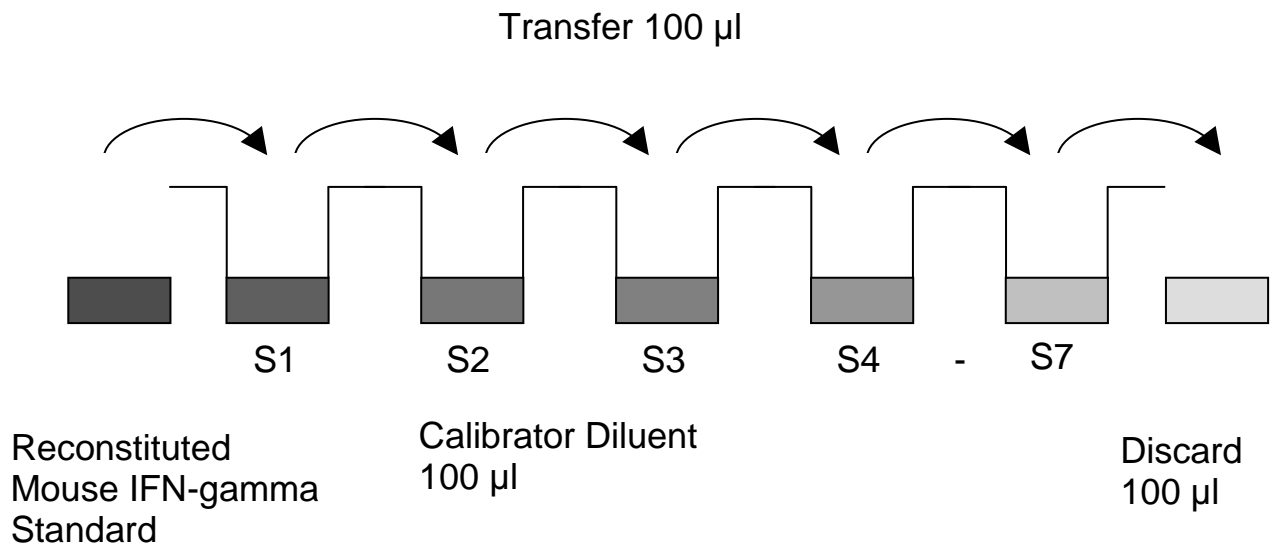

In case of an **external standard dilution** (see 9.5.1), pipette 100 µl of these standard dilutions (S1 – S7) in the standard wells according to Table 1.

Table 1

Table depicting an example of the arrangement of blanks, standards and samples in the microwell strips:

	1	2	3	4
A	Standard 1 (40.00 pg/ml)	Standard 1 (40.00 pg/ml)	Sample 1	Sample 1
B	Standard 2 (20.00 pg/ml)	Standard 2 (20.00 pg/ml)	Sample 2	Sample 2
C	Standard 3 (10.00 pg/ml)	Standard 3 (10.00 pg/ml)	Sample 3	Sample 3
D	Standard 4 (5.00 pg/ml)	Standard 4 (5.00 pg/ml)	Sample 4	Sample 4
E	Standard 5 (2.50 pg/ml)	Standard 5 (2.50 pg/ml)	Sample 5	Sample 5
F	Standard 6 (1.25 pg/ml)	Standard 6 (1.25 pg/ml)	Sample 6	Sample 6
G	Standard 7 (0.63 pg/ml)	Standard 7 (0.63 pg/ml)	Sample 7	Sample 7
H	Blank	Blank	Sample 8	Sample 8

- e. Add 100 µl of **Calibrator Diluent** in duplicate to the **blank wells**.
- f. Add 80 µl of **Sample Diluent** to the **sample wells**.
- g. Add 20 µl of each **sample** in duplicate to the **sample wells**.
- h. Add 50 µl of diluted **Biotin-Conjugate** to all wells, including the blank wells.
- i. Cover with an adhesive film and incubate at room temperature (18 to 25°C) for 2 hours on a microplate shaker. **(Shaking is absolutely necessary for an optimal test performance)**.
- j. Prepare **Streptavidin-HRP** (see Preparation of Streptavidin-HRP 9.4).
- k. Remove adhesive film and empty wells. **Wash** microwell strips 6 times according to point c of the test protocol. Proceed immediately to the next step.
- l. Add 100 µl of diluted **Streptavidin-HRP** to all wells, including the blank wells.
- m. Cover with an adhesive film and incubate at room temperature (18 to 25°C) for 1 hour on a microplate shaker. **(Shaking is absolutely necessary for an optimal test performance)**.
- n. Remove adhesive film and empty wells. **Wash** microwell strips 6 times according to point c of the test protocol. Proceed immediately to the next step.
- o. Pipette 100 µl of **TMB Substrate Solution** to all wells.
- p. Incubate the microwell strips at room temperature (18° to 25°C) for 30 minutes. Avoid direct exposure to intense light.

The colour development on the plate should be monitored and the substrate reaction stopped (see next point of this protocol) before positive wells are no longer properly recordable. Determination of the ideal time period for colour development has to be done individually for each assay.

It is recommended to add the stop solution when the highest standard has developed a dark blue colour. Alternatively the colour

development can be monitored by the ELISA reader at 620 nm. The substrate reaction should be stopped as soon as Standard 1 has reached an OD of 0.9 – 0.95.

- q. Stop the enzyme reaction by quickly pipetting 100 μ l of **Stop Solution** into each well. It is important that the Stop Solution is spread quickly and uniformly throughout the microwells to completely inactivate the enzyme. Results must be read immediately after the Stop Solution is added or within one hour if the microwell strips are stored at 2 - 8°C in the dark.
- r. Read absorbance of each microwell on a spectro-photometer using 450 nm as the primary wave length (optionally 620 nm as the reference wave length; 610 nm to 650 nm is acceptable). Blank the plate reader according to the manufacturer's instructions by using the blank wells. Determine the absorbance of both the samples and the standards.

Note: Shaking is absolutely necessary for an optimal test performance.

11 Calculation of Results

- Calculate the average absorbance values for each set of duplicate standards and samples. Duplicates should be within 20 per cent of the mean value.
- Create a standard curve by plotting the mean absorbance for each standard concentration on the ordinate against the mouse IFN-gamma concentration on the abscissa. Draw a best fit curve through the points of the graph (a 5-parameter curve fit is recommended).
- To determine the concentration of circulating mouse IFN-gamma for each sample, first find the mean absorbance value on the ordinate and extend a horizontal line to the standard curve. At the point of intersection, extend a vertical line to the abscissa and read the corresponding mouse IFN-gamma concentration.
- **If instructions in this protocol have been followed samples have been diluted 1:5 (20 µl sample + 80 µl Sample Diluent), the concentration read from the standard curve must be multiplied by the dilution factor (x 5).**
- **Calculation of samples with a concentration exceeding standard 1 may result in incorrect, low mouse IFN-gamma levels. Such samples require further external predilution according to expected mouse IFN-gamma values with Sample Diluent in order to precisely quantitate the actual mouse IFN-gamma level.**
- It is suggested that each testing facility establishes a control sample of known mouse IFN-gamma concentration and runs this additional control with each assay. If the values obtained are not within the expected range of the control, the assay results may be invalid.
- A representative standard curve is shown in Figure 8. This curve cannot be used to derive test results. Each laboratory must prepare a standard curve for each group of microwell strips assayed.

Figure 8

Representative standard curve for mouse IFN-gamma ELISA (extra sensitive). Mouse IFN-gamma was diluted in serial 2-fold steps in Calibrator Diluent. Do not use this standard curve to derive test results. A standard curve must be run for each group of microwell strips assayed.

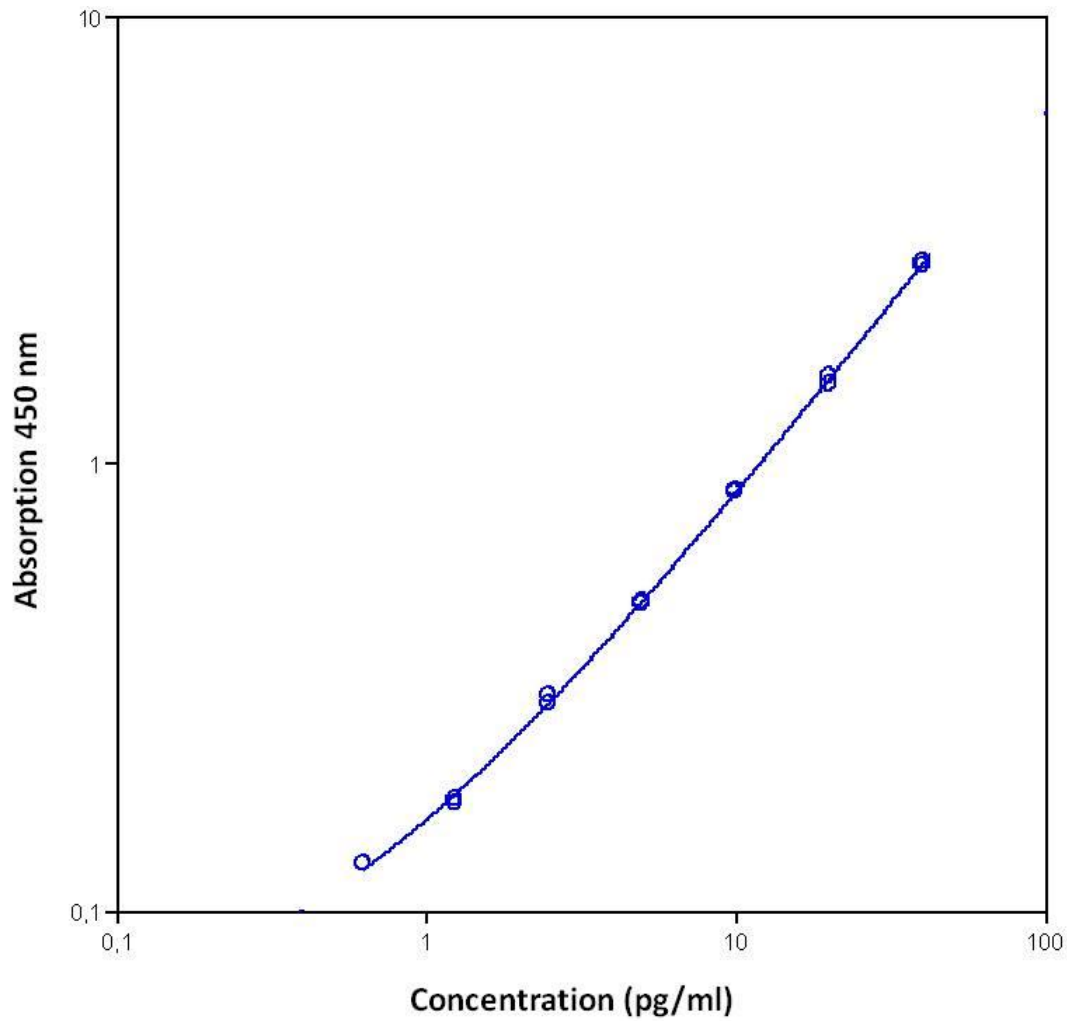

Table 2

Typical data using the mouse IFN-gamma ELISA (extra sensitive)

Measuring wavelength: 450 nm

Reference wavelength: 620 nm

Standard	Mouse IFN-gamma Concentration (pg/ml)	O.D. at 450 nm	Mean O.D. at 450 nm	C.V. (%)
1	40.00	2.828 2.765	2.797	1.1
2	20.00	1.582 1.503	1.542	2.6
3	10.00	0.879 0.867	0.873	0.7
4	5.00	0.486 0.492	0.489	0.6
5	2.50	0.303 0.291	0.297	2.0
6	1.25	0.178 0.174	0.176	1.3
7	0.63	0.128 0.128	0.128	0.1
Blank	0.00	0.059 0.051	0.055	7.1

The OD values of the standard curve may vary according to the conditions of assay performance (e.g. operator, pipetting technique, washing technique or temperature effects). Furthermore shelf life of the kit may affect enzymatic activity and thus colour intensity. Values measured are still valid.

12 Limitations

- Since exact conditions may vary from assay to assay, a standard curve must be established for every run.
- Bacterial or fungal contamination of either screen samples or reagents or cross-contamination between reagents may cause erroneous results.
- Disposable pipette tips, flasks or glassware are preferred, reusable glassware must be washed and thoroughly rinsed of all detergents before use.
- Improper or insufficient washing at any stage of the procedure will result in either false positive or false negative results. Empty wells completely before dispensing fresh wash solution, fill with Wash Buffer as indicated for each wash cycle and do not allow wells to sit uncovered or dry for extended periods.

13 Performance Characteristics

13.1 Sensitivity

The limit of detection of mouse IFN-gamma defined as the analyte concentration resulting in an absorbance significantly higher than that of the dilution medium (mean plus 2 standard deviations) was determined to be 0.09 pg/ml (mean of 4 independent assays).

13.2 Reproducibility

13.2.1 Intra-assay

Reproducibility within the assay was evaluated in 3 independent experiments. Each assay was carried out with 6 replicates of 8 serum samples containing different concentrations of mouse IFN-gamma. 2 standard curves were run on each plate. Data below show the mean mouse IFN-gamma concentration and the coefficient of variation for each sample (see Table 3). The calculated overall intra-assay coefficient of variation was 3.5%.

Table 3

The mean mouse IFN-gamma concentration and the coefficient of variation for each sample

Sample	Experiment	Mean mouse IFN-gamma Concentration (pg/ml)	Coefficient of Variation (%)
1	1	42.8	5.4
	2	41.2	5.8
	3	47.4	2.7
2	1	23.4	3.7
	2	24.4	6.8
	3	24.5	2.1
3	1	12.1	3.1
	2	12.0	2.4
	3	11.9	2.7
4	1	124.1	3.3
	2	124.2	3.8
	3	119.2	1.2
5	1	60.7	3.2
	2	60.0	4.6
	3	59.9	2.3
6	1	28.3	3.0
	2	30.7	3.0
	3	30.6	6.8
7	1	97.9	2.9
	2	100.0	2.2
	3	96.2	2.7
8	1	47.2	4.3
	2	48.4	3.4
	3	48.0	2.6

13.2.2 Inter-assay

Assay to assay reproducibility within one laboratory was evaluated in 3 independent experiments. Each assay was carried out with 6 replicates of 8 serum samples containing different concentrations of mouse IFN-gamma. 2 standard curves were run on each plate. Data below show the mean mouse IFN-gamma concentration and the coefficient of variation calculated on 18 determinations of each sample (see Table 4). The calculated overall inter-assay coefficient of variation was 2.7%.

Table 4

The mean mouse IFN-gamma concentration and the coefficient of variation of each sample

Sample	Mean mouse IFN-gamma Concentration (pg/ml)	Coefficient of Variation (%)
1	44	7.4
2	24	2.3
3	12	1.2
4	123	2.4
5	60	0.7
6	30	4.5
7	98	1.9
8	48	1.3

13.3 Spike Recovery

The spike recovery was evaluated by spiking 3 levels of mouse IFN-gamma into serum, plasma (EDTA, citrate) and cell culture supernatant. Recoveries were determined with 2 replicates each. The amount of endogenous mouse IFN-gamma in unspiked samples was subtracted from the spike values.

For recovery data see Table 5.

Table 5

Sample matrix	Spike high		Spike medium		Spike low	
	Mean (%)	Range (%)	Mean (%)	Range (%)	Mean (%)	Range (%)
Serum	89	81 – 97	102	98 – 106	101	97 – 106
Plasma (EDTA)	96	92 – 101	107	101 – 113	105	102 – 108
Plasma (citrate)	111	108 – 113	100	99 – 101	92	-
Cell culture supernatant	107	106 – 107	107	106 - 108	95	94 – 95

13.4 Dilution Parallelism

Serum, plasma (EDTA, citrate) and cell culture supernatant samples with different levels of mouse IFN-gamma were analysed at serial 2-fold dilutions with 4 replicates each.

For data see Table 6.

Table 6

Sample matrix	Recovery of Exp. Val.		
	Dilution	Mean (%)	Range (%)
Serum	1:4	94	87 – 100
	1:8	88	77 – 95
	1:16	104	98 – 110
Plasma (EDTA)	1:4	100	-
	1:8	107	-
	1:16	114	-
Plasma (citrate)	1:4	105	102 – 108
	1:8	114	112 – 115
	1:16	114	113 – 115
Cell culture supernatant	1:4	95	91 – 99
	1:8	81	76 – 86

	1:16	105	104 – 106
--	------	-----	-----------

13.5 Sample Stability

13.5.1 Freeze-Thaw Stability

Aliquots of spiked serum samples were stored at -20°C and thawed 3 times, and the mouse IFN-gamma levels determined. There was no significant loss of mouse IFN-gamma immunoreactivity detected by freezing and thawing.

13.5.2 Storage Stability

Aliquots of spiked serum samples were stored at -20°C, 2-8°C, room temperature (RT) and at 37°C, and the mouse IFN-gamma level determined after 24 h. There was no significant loss of mouse IFN-gamma immunoreactivity detected during storage under above conditions.

13.6 Specificity

The interference of circulating factors of the immune system was evaluated by spiking these proteins at physiologically relevant concentrations into a mouse IFN-gamma positive serum.

There was no crossreactivity detected with mouse GM-CSF, IL-1alpha, IL-2, IL-4, IL-5, IL-6, IL-10 and IL-17.

14 Ordering Information

North America

Technical Support:

Research Products:
888.810.6168
858.642.2058
tech@eBioscience.com

Clinical Products:
877.726.8559
858.642.2058
tech@eBioscience.com

Customer Service:

888.999.1371
858.642.2058
info@eBioscience.com

Fax:

858.642.2046

Europe/International*

Technical Support:

+43 1 796 40 40-120
tech@eBioscience.com

Customer Service:

+43 1 796 40 40-304
info@eBioscience.com

Fax:

+43 1 796 40 40-400



Bender MedSystems GmbH
Campus Vienna Biocenter 2
1030 Vienna, Austria
www.eBioscience.com

* Customers outside North America and Europe may contact their eBioscience distributor listed on our website at www.eBioscience.com/distributors.

15 Reagent Preparation Summary

15.1 Wash Buffer (1x)

Add **Wash Buffer Concentrate** 20x (50 ml) to 950 ml distilled water.

Number of Strips	Wash Buffer Concentrate (ml)	Distilled Water (ml)
1 - 6	25	475
1 - 12	50	950

15.2 Assay Buffer (1x)

Add **Assay Buffer Concentrate** 20x (5 ml) to 95 ml distilled water.

Number of Strips	Assay Buffer Concentrate (ml)	Distilled Water (ml)
1 - 6	2.5	47.5
1 - 12	5.0	95.0

15.3 Biotin-Conjugate

Make a 1:100 dilution of the concentrated **Biotin-Conjugate** solution with **Sample Diluent** in a clean plastic tube as needed according to the following table:

Number of Strips	Biotin-Conjugate (ml)	Sample Diluent (ml)
1 - 6	0.03	2.97
1 - 12	0.06	5.94

15.4 Streptavidin-HRP

Make a 1:100 dilution of the concentrated **Streptavidin-HRP** solution with **Assay Buffer (1x)** in a clean plastic tube as needed according to the following table:

Number of Strips	Streptavidin-HRP (ml)	Assay Buffer (1x) (ml)
1 - 6	0.06	5.94
1 - 12	0.12	11.88

15.5 Mouse IFN-gamma Standard

Reconstitute **mouse IFN-gamma standard** with Calibrator Diluent. (Reconstitution volume is stated on the label of the standard vial.)

16 Test Protocol Summary

1. Determine the number of microwell strips required.
2. Prepare Biotin-Conjugate.
3. Wash microwell strips twice with Wash Buffer.
4. Standard dilution on the microwell plate: Add 100 µl Calibrator Diluent, in duplicate, to all standard wells. Pipette 100 µl prepared standard into the first wells and create standard dilutions by transferring 100 µl from well to well. Discard 100 µl from the last wells.
Alternatively external standard dilution in tubes (see 9.5.1):
Pipette 100 µl of these standard dilutions in the microwell strips.
5. Add 100 µl of Calibrator Diluent in duplicate to the blank wells.
6. Add 80 µl of Sample Diluent to the sample wells.
7. Add 20 µl of each sample in duplicate to the sample wells.
8. Add 50 µl diluted Biotin-Conjugate to all wells.
9. Cover microwell strips and incubate 2 hours at room temperature (18°-25°C) on a microplate shaker. **(Shaking is absolutely necessary for an optimal test performance).**
10. Prepare Streptavidin-HRP.
11. Empty and wash microwell strips 6 times with Wash Buffer.
12. Add 100 µl diluted Streptavidin-HRP to all wells.
13. Cover microwell strips and incubate 1 hour at room temperature (18°-25°C) on a microplate shaker. **(Shaking is absolutely necessary for an optimal test performance).**
14. Empty and wash microwell strips 6 times with Wash Buffer.
15. Add 100 µl of TMB Substrate Solution to all wells.
16. Incubate the microwell strips for about 30 minutes at room temperature (18°C to 25°C)
17. Add 100 µl Stop Solution to all wells.
18. Blank microwell reader and measure colour intensity at 450 nm.

If instructions in this protocol have been followed samples have been diluted 1:5 (20 µl sample + 80 µl Sample Diluent), the concentration read from the standard curve must be multiplied by the dilution factor (x 5).