

PRODUCT INFORMATION & MANUAL

Human IL-33 Platinum ELISA

BMS2048 / BMS2048TEN

Enzyme-linked Immunosorbent Assay for
quantitative detection of human IL-33.

For research use only.

Not for diagnostic or therapeutic procedures.



*Human IL-33
Platinum ELISA*

North America

Technical Support:

Research Products:
888.810.6168
858.642.2058
tech@eBioscience.com

Clinical Products:
877.726.8559
858.642.2058
tech@eBioscience.com

Customer Service:

888.999.1371
858.642.2058
info@eBioscience.com

Fax:

858.642.2046

Europe/International*

Technical Support:

+43 1 796 40 40-120
tech@eBioscience.com

Customer Service:

+43 1 796 40 40-304
info@eBioscience.com

Fax:

+43 1 796 40 40-400



Bender MedSystems GmbH
Campus Vienna Biocenter 2
1030 Vienna, Austria
www.eBioscience.com

* Customers outside North America and Europe may contact their eBioscience distributor listed on our website at www.eBioscience.com/distributors.

TABLE OF CONTENTS

1	Intended Use	3
2	Summary	3
3	Principles of the Test	5
4	Reagents Provided	7
5	Storage Instructions – ELISA Kit	9
6	Specimen Collection and Storage Instructions	9
7	Materials Required But Not Provided	10
8	Precautions for Use	11
9	Preparation of Reagents	13
10	Test Protocol	18
11	Calculation of Results	22
12	Limitations	25
13	Performance Characteristics	26
14	Ordering Information	31
15	Reagent Preparation Summary	32
16	Test Protocol Summary	33

1 Intended Use

The human IL-33 ELISA is an enzyme-linked immunosorbent assay for the quantitative detection of human IL-33. **The human IL-33 ELISA is for research use only. Not for diagnostic or therapeutic procedures.**

2 Summary

IL-33 is the 11th and most recently discovered member of the IL-1 family of cytokines, which furthermore includes IL-1 α , IL-1 β , IL-18 and IL-1Ra. As with IL-1 β and IL-18, the synthesized 30 kDa propeptide IL-33 lacks a clear signal peptide for direct processing via the endoplasmic reticulum and Golgi apparatus. In vivo, caspase-1 cleaves the pro-IL-1 β and pro-IL-18 bioactive forms, an essential step for their subsequent secretion. The mechanism for IL-33 might be similar, but the process has not been fully elucidated yet. In vitro, caspase-1 can cleave human IL-33, which results in a 20-22 kDa mature form.

In humans, IL-33 mRNA is predominantly found in dermal fibroblasts, bronchial and small airway epithelial cells and smooth muscle cells of skin and lung tissues. Later, cellular mRNA expression has been observed in adipocytes, synovial fibroblasts, high endothelial venules, and endothelial cells. Furthermore, IL-33 is expressed in fibroblastic reticular cells of lymphoid tissues, skin keratinocytes, epithelial cells of stomach, tonsillar crypts and salivary glands, cardiac fibroblasts and cardiomyocytes. In most cells the predominant localization of IL-33 is nuclear rather than cytoplasmic. IL-33 specifically binds to IL1RL-1, which is known also as ST2, and is part of the IL-1R family.

IL-33 promotes the release of Th2-associated cytokines from in vitro polarized human and murine Th2 cells, and also acts as a Th2 chemotactic factor. IL-33-promoting cytokine production activates human basophils and probably also regulates their migration. IL-33 influence on activation, degranulation, enhanced adhesion and survival of eosinophils has been shown. Mast cells are well-studied responders to IL-33. The cytokine increases synthesis of IL-6, IL-13, IL-1 β , TNF- α , prostaglandin D2 and MCP-1 by primary bone marrow-derived mast cells. Other cells activated by IL-33 are cardiomyocytes, glial cells and CD34+ cells.

Studies have shown a role of ST2/IL-33 in asthma. Serum levels of soluble ST2 are increased in patients with acute exacerbation of asthma. IL-33 has been shown to exacerbate allergic airway inflammation by promoting IL-5+ T cells. Increased serum levels were also detected in patients with rhinitis and atopic patients with anaphylaxis. IL-33 gene polymorphism appears to be associated with allergic rhinitis and Alzheimer's disease.

IL-33 protein is expressed in normal and diseased synovium, but diseased tissue displays higher levels of expression. It has been demonstrated that soluble ST2 plays a role in inflammatory responses in arthritis. Increased levels can be found in synovial fluid in RA patients compared to osteoarthritis controls. Furthermore, patients suffering from other rheumatic diseases such as systemic lupus erythematosus, progressive systemic sclerosis, Wegener's granulomatosis and Behcet's disease show increased serum IL-33 concentrations.

For literature update refer to www.eBioscience.com

3 Principles of the Test

An anti-human IL-33 coating antibody is adsorbed onto microwells.

Human IL-33 present in the sample or standard binds to antibodies adsorbed to the microwells.

Following incubation unbound biological components are removed during a wash step. A biotin-conjugated anti-human IL-33 antibody is added and binds to human IL-33 captured by the first antibody.

Following incubation unbound biotin-conjugated anti-human IL-33 antibody is removed during a wash step. Streptavidin-HRP is added and binds to the biotin-conjugated anti-human IL-33 antibody.

Figure 1

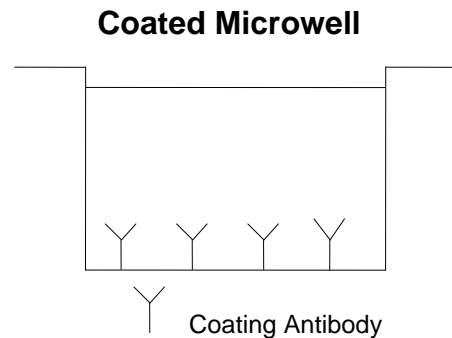

Figure 2

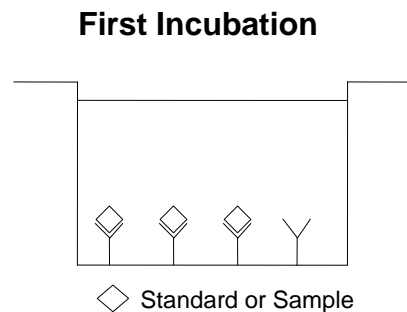

Figure 3

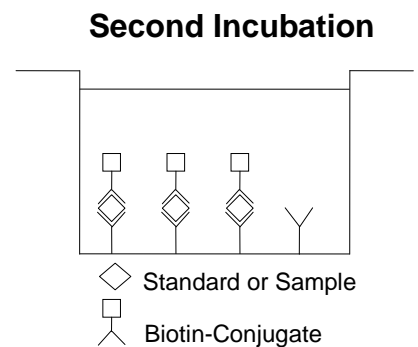
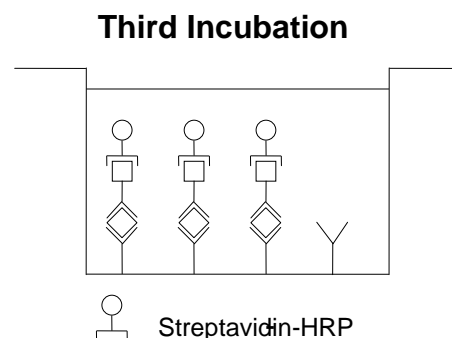
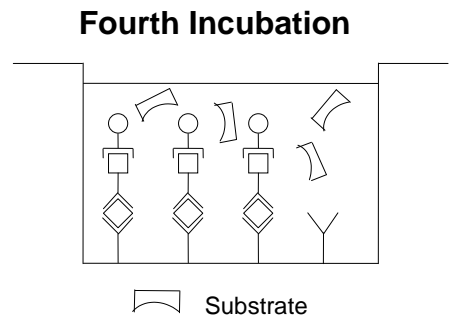

Figure 4



Following incubation unbound Streptavidin-HRP is removed during a wash step, and substrate solution reactive with HRP is added to the wells.

Figure 5



A coloured product is formed in proportion to the amount of human IL-33 present in the sample or standard. The reaction is terminated by addition of acid and absorbance is measured at 450 nm. A standard curve is prepared from 7 human IL-33 standard dilutions and human IL-33 sample concentration determined.

Figure 6

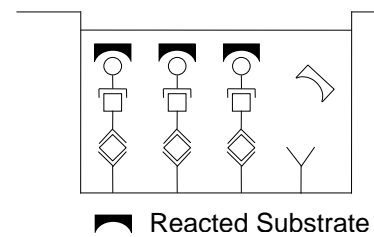

4 Reagents Provided

4.1 Reagents for human IL-33 ELISA BMS2048 (96 tests)

- 1 aluminium pouch with a **Microwell Plate coated** with polyclonal polyclonal antibody to human IL-33
- 1 vial (140 µl) **Biotin-Conjugate** anti-human IL-33 polyclonal polyclonal antibody
- 1 vial (150 µl) **Streptavidin-HRP**
- 2 vials human IL-33 **Standard** lyophilized, 500 pg/ml upon reconstitution
- 1 vial (12 ml) **Sample Diluent**
- 1 vial (15 ml) **Conjugate Diluent**
- 1 vial (5 ml) **Calibrator Diluent**
- 1 vial (5 ml) **Assay Buffer Concentrate 20x**
(PBS with 1% Tween 20 and 10% BSA)
- 1 bottle (50 ml) **Wash Buffer Concentrate 20x**
(PBS with 1% Tween 20)
- 1 vial (15 ml) **Substrate Solution** (tetramethyl-benzidine)
- 1 vial (15 ml) **Stop Solution** (1M Phosphoric acid)
- 1 vial (0.4 ml) **Blue-Dye**
- 1 vial (0.4 ml) **Green-Dye**
- 1 vial (0.4 ml) **Red-Dye**
- 6 **Adhesive Films**

4.2 Reagents for human IL-33 ELISA BMS2048TEN (10x96 tests)

- 10 aluminium pouches with a **Microwell Plate coated** with polyclonal antibody to human IL-33
- 10 vials (140 µl) **Biotin-Conjugate** anti-human IL-33 polyclonal antibody
- 10 vials (150 µl) **Streptavidin-HRP**
- 10 vials human IL-33 **Standard** lyophilized, 500 pg/ml upon reconstitution
- 10 vials (12 ml) **Sample Diluent**
- 10 vials (15 ml) **Conjugate Diluent**
- 5 vials (5 ml) **Calibrator Diluent**
- 3 vials (5 ml) **Assay Buffer Concentrate 20x**
(PBS with 1% Tween 20 and 10% BSA)
- 8 bottles (50 ml) **Wash Buffer Concentrate 20x**
(PBS with 1% Tween 20)
- 10 vials (15 ml) **Substrate Solution** (tetramethyl-benzidine)
- 10 vials (15 ml) **Stop Solution** (1M Phosphoric acid)
- 6 vials (0.4 ml) **Blue-Dye**
- 6 vials (0.4 ml) **Green-Dye**
- 6 vials (0.4 ml) **Red-Dye**
- 30 **Adhesive Films**

5 Storage Instructions – ELISA Kit

Store kit reagents between 2° and 8°C. Immediately after use remaining reagents should be returned to cold storage (2° to 8°C). Expiry of the kit and reagents is stated on labels.

Expiry of the kit components can only be guaranteed if the components are stored properly, and if, in case of repeated use of one component, this reagent is not contaminated by the first handling.

6 Specimen Collection and Storage Instructions

Cell culture supernatant, serum and plasma (citrate, heparin) were tested with this assay. Other biological samples might be suitable for use in the assay. Remove serum or plasma from the clot or cells as soon as possible after clotting and separation.

Samples containing a visible precipitate must be clarified prior to use in the assay. Do not use grossly hemolyzed or lipemic specimens.

Samples should be aliquoted and must be stored frozen at -20°C to avoid loss of bioactive human IL-33. If samples are to be run within 24 hours, they may be stored at 2° to 8°C (for sample stability refer to 13.5).

Avoid repeated freeze-thaw cycles. Prior to assay, the frozen sample should be brought to room temperature slowly and mixed gently.

7 Materials Required But Not Provided

- 5 ml and 10 ml graduated pipettes
- 5 μ l to 1000 μ l adjustable single channel micropipettes with disposable tips
- 50 μ l to 300 μ l adjustable multichannel micropipette with disposable tips
- Multichannel micropipette reservoir
- Beakers, flasks, cylinders necessary for preparation of reagents
- Device for delivery of wash solution (multichannel wash bottle or automatic wash system)
- Microplate shaker
- Microwell strip reader capable of reading at 450 nm (620 nm as optional reference wave length)
- Glass-distilled or deionized water
- Statistical calculator with program to perform regression analysis

8 Precautions for Use

- All reagents should be considered as potentially hazardous. We therefore recommend that this product is handled only by those persons who have been trained in laboratory techniques and that it is used in accordance with the principles of good laboratory practice. Wear suitable protective clothing such as laboratory overalls, safety glasses and gloves. Care should be taken to avoid contact with skin or eyes. In the case of contact with skin or eyes wash immediately with water. See material safety data sheet(s) and/or safety statement(s) for specific advice.
- Reagents are intended for research use only and are not for use in diagnostic or therapeutic procedures.
- Do not mix or substitute reagents with those from other lots or other sources.
- Do not use kit reagents beyond expiration date on label.
- Do not expose kit reagents to strong light during storage or incubation.
- Do not pipette by mouth.
- Do not eat or smoke in areas where kit reagents or samples are handled.
- Avoid contact of skin or mucous membranes with kit reagents or specimens.
- Rubber or disposable latex gloves should be worn while handling kit reagents or specimens.
- Avoid contact of substrate solution with oxidizing agents and metal.
- Avoid splashing or generation of aerosols.
- In order to avoid microbial contamination or cross-contamination of reagents or specimens which may invalidate the test use disposable pipette tips and/or pipettes.
- Use clean, dedicated reagent trays for dispensing the conjugate and substrate reagent.

- Exposure to acid inactivates the conjugate.
- Glass-distilled water or deionized water must be used for reagent preparation.
- Substrate solution must be at room temperature prior to use.
- Decontaminate and dispose specimens and all potentially contaminated materials as they could contain infectious agents. The preferred method of decontamination is autoclaving for a minimum of 1 hour at 121.5°C.
- Liquid wastes not containing acid and neutralized waste may be mixed with sodium hypochlorite in volumes such that the final mixture contains 1.0% sodium hypochlorite. Allow 30 minutes for effective decontamination. Liquid waste containing acid must be neutralized prior to the addition of sodium hypochlorite.

9 Preparation of Reagents

Buffer Concentrates should be brought to room temperature and should be diluted before starting the test procedure.

If crystals have formed in the **Buffer Concentrates**, warm them gently until they have completely dissolved.

9.1 Wash Buffer (1x)

Pour entire contents (50 ml) of the **Wash Buffer Concentrate** (20x) into a clean 1000 ml graduated cylinder. Bring to final volume of 1000 ml with glass-distilled or deionized water. Mix gently to avoid foaming.

Transfer to a clean wash bottle and store at 2° to 25°C. Please note that Wash Buffer (1x) is stable for 30 days.

Wash Buffer (1x) may also be prepared as needed according to the following table:

Number of Strips	Wash Buffer Concentrate (20x) (ml)	Distilled Water (ml)
1 - 6	25	475
1 - 12	50	950

9.2 Assay Buffer (1x)

Pour the entire contents (5 ml) of the **Assay Buffer Concentrate** (20x) into a clean 100 ml graduated cylinder. Bring to final volume of 100 ml with distilled water. Mix gently to avoid foaming.

Store at 2° to 8°C. Please note that the Assay Buffer (1x) is stable for 30 days.

Assay Buffer (1x) may also be prepared as needed according to the following table:

Number of Strips	Assay Buffer Concentrate (20x) (ml)	Distilled Water (ml)
1 - 6	2.5	47.5
1 - 12	5.0	95.0

9.3 Biotin-Conjugate

Please note that the Biotin-Conjugate should be used within 30 minutes after dilution.

Make a 1:100 dilution of the concentrated **Biotin-Conjugate** solution with Conjugate Diluent in a clean plastic tube as needed according to the following table:

Number of Strips	Biotin-Conjugate (ml)	Conjugate Diluent (ml)
1 - 6	0.06	5.94
1 - 12	0.12	11.88

9.4 Streptavidin-HRP

Please note that the Streptavidin-HRP should be used within 30 minutes after dilution.

Make a 1:100 dilution of the concentrated **Streptavidin-HRP** solution with Assay Buffer (1x) in a clean plastic tube as needed according to the following table:

Number of Strips	Streptavidin-HRP (ml)	Assay Buffer (1x) (ml)
1 - 6	0.06	5.94
1 - 12	0.12	11.88

9.5 Human IL-33 Standard

Reconstitute **human IL-33 standard** by addition of Calibrator Diluent. Reconstitution volume is stated on the label of the standard vial. Swirl or mix gently to insure complete and homogeneous solubilization (concentration of reconstituted standard = 500 pg/ml). Allow the standard to reconstitute for 10-30 minutes. Mix well prior to making dilutions.

After usage remaining standard cannot be stored and has to be discarded.

9.5.1 Standard Dilution

Label 6 tubes, one for each standard point.

S2, S3, S4, S5, S6, S7

Then prepare 1:2 serial dilutions for the standard curve as follows:

Pipette 150 µl of Calibrator Diluent into each tube.

Pipette 150 µl of reconstituted standard (serves as highest standard S1 = 500 pg/ml) into the first tube, labelled S2, and mix (concentration of standard 2 = 250 pg/ml).

Pipette 150 µl of this dilution into the second tube, labelled S3, and mix thoroughly before the next transfer.

Repeat serial dilutions 4 more times thus creating the points of the standard curve (see Figure 7).

Calibrator Diluent serves as blank.

Figure 7

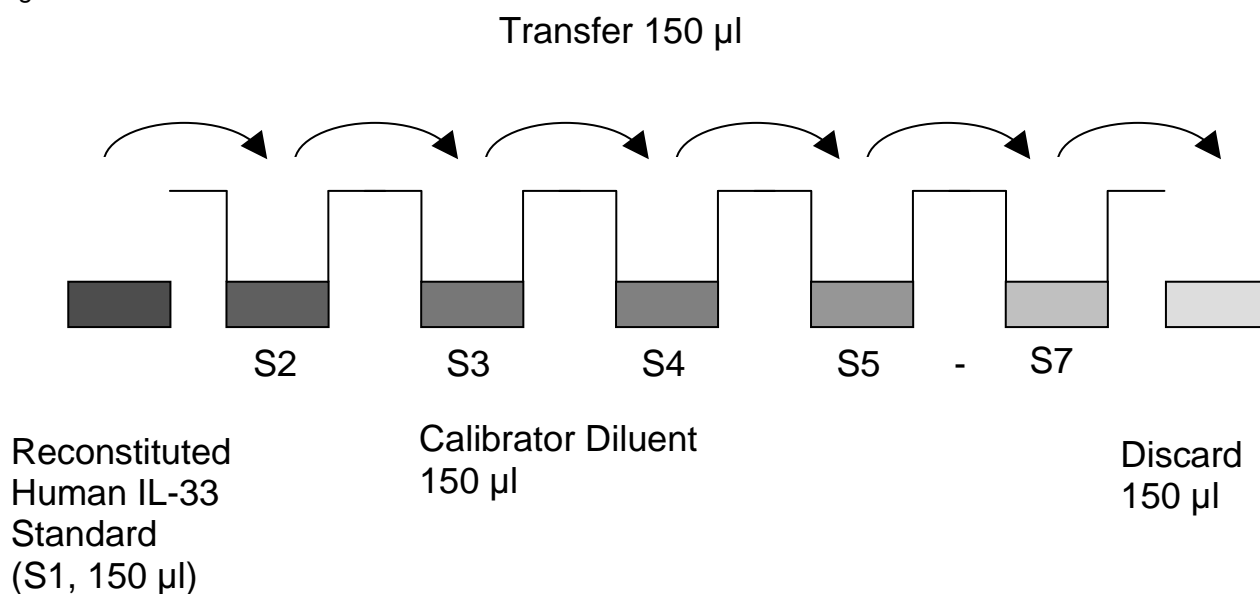

9.6 Addition of Colour-giving Reagents: Blue-Dye, Green-Dye, Red-Dye

In order to help our customers to avoid any mistakes in pipetting the Bender MedSystems ELISAs, Bender MedSystems offers a tool that helps to monitor the addition of even very small volumes of a solution to the reaction well by giving distinctive colours to each step of the ELISA procedure.

This procedure is optional, does not in any way interfere with the test results, and is designed to help the customer with the performance of the test, but can also be omitted, just following the instruction booklet.

Alternatively, the dye solutions from the stocks provided (**Blue-Dye, Green-Dye, Red-Dye**) can be added to the reagents according to the following guidelines:

1. **Diluent:** Before standard dilution add the **Blue-Dye** at a dilution of 1:250 (see table below) to the appropriate diluent (1x) according to the test protocol. After addition of **Blue-Dye**, proceed according to the instruction booklet.

5 ml Calibrator Diluent	20 μ l Blue-Dye
12 ml Calibrator Diluent	48 μ l Blue-Dye
50 ml Calibrator Diluent	200 μ l Blue-Dye

- 2. Biotin-Conjugate:** Before dilution of the concentrated Biotin-Conjugate, add the **Green-Dye** at a dilution of 1:100 (see table below) to the Conjugate Diluent used for the final conjugate dilution. Proceed after addition of **Green-Dye** according to the instruction booklet: Preparation of Biotin-Conjugate.

3 ml Conjugate Diluent	30 μ l Green-Dye
6 ml Conjugate Diluent	60 μ l Green-Dye
12 ml Conjugate Diluent	120 μ l Green-Dye

- 3. Streptavidin-HRP:** Before dilution of the concentrated Streptavidin-HRP, add the **Red-Dye** at a dilution of 1:250 (see table below) to the Assay Buffer (1x) used for the final Streptavidin-HRP dilution. Proceed after addition of **Red-Dye** according to the instruction booklet: Preparation of Streptavidin-HRP.

6 ml Assay Buffer (1x)	24 μ l Red-Dye
12 ml Assay Buffer (1x)	48 μ l Red-Dye

10 Test Protocol

- a. Determine the number of microwell strips required to test the desired number of samples plus appropriate number of wells needed for running blanks and standards. Each sample, standard, blank and optional control sample should be assayed in duplicate. Remove extra microwell strips from holder and store in foil bag with the desiccant provided at 2°-8°C sealed tightly.
- b. Wash the microwell strips twice with approximately 400 µl **Wash Buffer** per well with thorough aspiration of microwell contents between washes. Allow the Wash Buffer to sit in the wells for about **10 – 15 seconds** before aspiration. Take care not to scratch the surface of the microwells.
After the last wash step, empty wells and tap microwell strips on absorbent pad or paper towel to remove excess Wash Buffer. Use the microwell strips immediately after washing. Alternatively microwell strips can be placed upside down on a wet absorbent paper for not longer than 15 minutes. **Do not allow wells to dry.**
- c. Add 50 µl of **Sample Diluent** to **all wells**.
- d. Add 50 µl of each prepared **Standard dilution** in duplicate to the corresponding **standard well** (see Table 1).
- e. Add 50 µl **Calibrator Diluent** to the **blank wells**.
- f. Add 50 µl µl of each **sample** in duplicate to the **sample wells** (see Table 1).

Table 1

Table depicting an example of the arrangement of blanks, standards and samples in the microwell strips:

	1	2	3	4
A	Standard 1 (500.0 pg/ml)	Standard 1 (500.0 pg/ml)	Sample 1	Sample 1
B	Standard 2 (250.0 pg/ml)	Standard 2 (250.0 pg/ml)	Sample 2	Sample 2
C	Standard 3 (125.0 pg/ml)	Standard 3 (125.0 pg/ml)	Sample 3	Sample 3
D	Standard 4 (62.5 pg/ml)	Standard 4 (62.5 pg/ml)	Sample 4	Sample 4
E	Standard 5 (31.3 pg/ml)	Standard 5 (31.3 pg/ml)	Sample 5	Sample 5
F	Standard 6 (15.6pg/ml)	Standard 6 (15.6pg/ml)	Sample 6	Sample 6
G	Standard 7 (7.8 pg/ml)	Standard 7 (7.8 pg/ml)	Sample 7	Sample 7
H	Blank	Blank	Sample 8	Sample 8

- g. Cover with an adhesive film and incubate at room temperature (18° to 25°C) for 2 hours, on a microplate shaker set at 400 rpm. **(Shaking is absolutely necessary for an optimal test performance.)**
- h. Prepare **Biotin-Conjugate** (see Preparation of Biotin-Conjugate 9.3).
- i. Remove adhesive film and empty wells. **Wash** microwell strips 6 times according to point b. of the test protocol. Proceed immediately to the next step.
- j. Add 100 µl of **Biotin-Conjugate** to all wells.
- k. Cover with an adhesive film and incubate at room temperature (18° to 25°C) for 1 hour, on a microplate shaker set at 400 rpm. **(Shaking is absolutely necessary for an optimal test performance.)**
- l. Prepare **Streptavidin-HRP** (refer to Preparation of Streptavidin-HRP 9.4).
- m. Remove adhesive film and empty wells. **Wash** microwell strips 6 times according to point b. of the test protocol. Proceed immediately to the next step.
- n. Add 100 µl of diluted **Streptavidin-HRP** to all wells, including the blank wells.
- o. Cover with an adhesive film and incubate at room temperature (18° to 25°C) for 1 hour, on a microplate shaker set at 400 rpm. **(Shaking is absolutely necessary for an optimal test performance.)**
- p. Remove adhesive film and empty wells. **Wash** microwell strips 6 times according to point b. of the test protocol. Proceed immediately to the next step.
- q. Pipette 100 µl of **TMB Substrate Solution** to all wells.
- r. Incubate the microwell strips at room temperature (18° to 25°C) for about 30 min. Avoid direct exposure to intense light.

The colour development on the plate should be monitored and the substrate reaction stopped (see next point of this protocol) before positive wells are no longer properly recordable. Determination of the ideal time period for colour development has to be done individually for each assay.

It is recommended to add the stop solution when the highest standard has developed a dark blue colour. Alternatively the colour development can be monitored by the ELISA reader at 620 nm. The substrate reaction should be stopped as soon as Standard 1 has reached an OD of 0.9 – 0.95.

- s. Stop the enzyme reaction by quickly pipetting 100 µl of **Stop Solution** into each well. It is important that the Stop Solution is spread quickly and uniformly throughout the microwells to completely inactivate the enzyme. Results must be read immediately after the Stop Solution is added or within one hour if the microwell strips are stored at 2 - 8°C in the dark.
- t. Read absorbance of each microwell on a spectro-photometer using 450 nm as the primary wave length (optionally 620 nm as the reference wave length; 610 nm to 650 nm is acceptable). Blank the plate reader according to the manufacturer's instructions by using the blank wells. Determine the absorbance of both the samples and the standards.

11 Calculation of Results

- Calculate the average absorbance values for each set of duplicate standards and samples. Duplicates should be within 20 per cent of the mean value.
- Create a standard curve by plotting the mean absorbance for each standard concentration on the ordinate against the human IL-33 concentration on the abscissa. Draw a best fit curve through the points of the graph (a 5-parameter curve fit is recommended).
- To determine the concentration of circulating human IL-33 for each sample, first find the mean absorbance value on the ordinate and extend a horizontal line to the standard curve. At the point of intersection, extend a vertical line to the abscissa and read the corresponding human IL-33 concentration.
- **Calculation of samples with a concentration exceeding standard may result in incorrect, low human IL-33 levels. Such samples require further external predilution according to expected human IL-33 values with Sample Diluent in order to precisely quantitate the actual human IL-33 level.**
- It is suggested that each testing facility establishes a control sample of known human IL-33 concentration and runs this additional control with each assay. If the values obtained are not within the expected range of the control, the assay results may be invalid.
- A representative standard curve is shown in Figure 8. This curve cannot be used to derive test results. Each laboratory must prepare a standard curve for each group of microwell strips assayed.

Figure 8

Representative standard curve for human IL-33 ELISA. Human IL-33 was diluted in serial 2-fold steps in Calibrator Diluent. Do not use this standard curve to derive test results. A standard curve must be run for each group of microwell strips assayed.

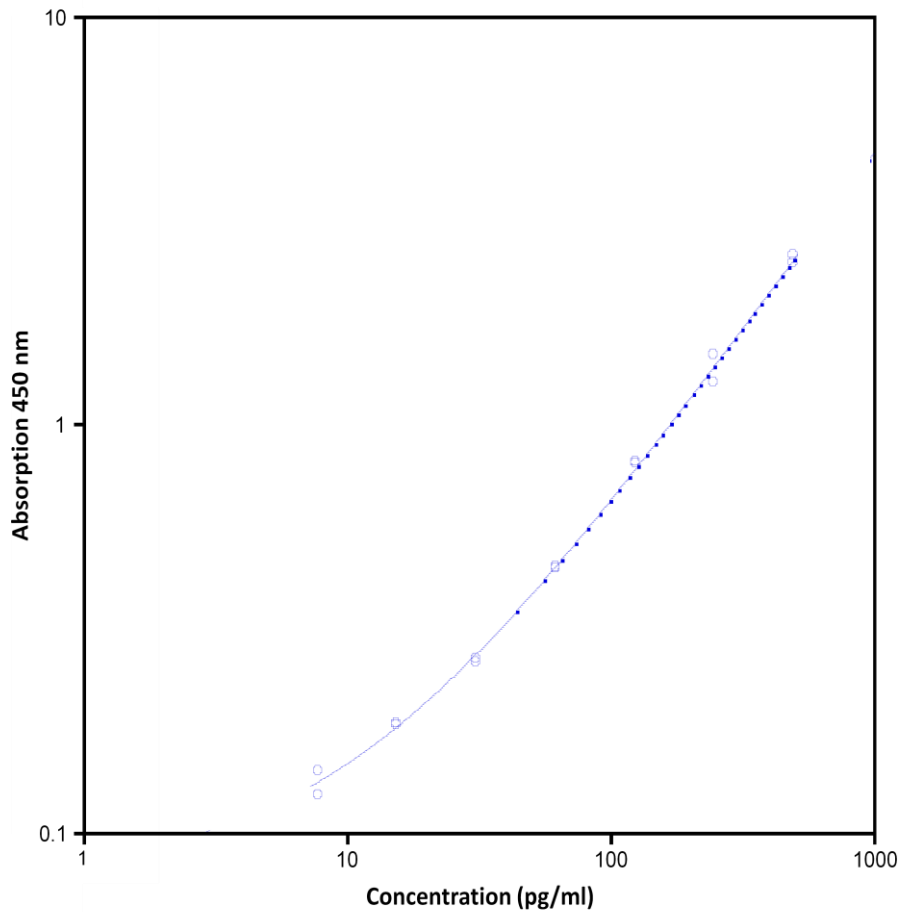

Table 2

Typical data using the human IL-33 ELISA

Measuring wavelength: 450 nm

Reference wavelength: 620 nm

Standard	Human IL-33 Concentration (pg/ml)	O.D. at 450 nm	Mean O.D. at 450 nm	C.V. (%)
1	500.0	2.489 2.583	2.536	2.6
2	250.0	1.257 1.475	1.366	11.3
3	125.0	0.801 0.811	0.806	0.9
4	62.5	0.449 0.442	0.446	1.0
5	31.3	0.259 0.265	0.262	1.7
6	15.6	0.183 0.185	0.184	1.0
7	7.8	0.123 0.141	0.132	9.6
Blank	0	0.074 0.082	0.078	7.2

The OD values of the standard curve may vary according to the conditions of assay performance (e.g. operator, pipetting technique, washing technique or temperature effects). Furthermore shelf life of the kit may affect enzymatic activity and thus colour intensity. Values measured are still valid.

12 Limitations

- Since exact conditions may vary from assay to assay, a standard curve must be established for every run.
- Bacterial or fungal contamination of either screen samples or reagents or cross-contamination between reagents may cause erroneous results.
- Disposable pipette tips, flasks or glassware are preferred, reusable glassware must be washed and thoroughly rinsed of all detergents before use.
- Improper or insufficient washing at any stage of the procedure will result in either false positive or false negative results. Empty wells completely before dispensing fresh wash solution, fill with Wash Buffer as indicated for each wash cycle and do not allow wells to sit uncovered or dry for extended periods.

13 Performance Characteristics

13.1 Sensitivity

The limit of detection of human IL-33 defined as the analyte concentration resulting in an absorbance significantly higher than that of the dilution medium (mean plus 2 standard deviations) was determined to be 0.2 pg/ml (mean of 6 independent assays).

13.2 Reproducibility

13.2.1 Intra-assay

Reproducibility within the assay was evaluated in 3 independent experiments. Each assay was carried out with 6 replicates of 8 serum samples containing different concentrations of human IL-33. 2 standard curves were run on each plate. Data below show the mean human IL-33 concentration and the coefficient of variation for each sample (see Table 3). The calculated overall intra-assay coefficient of variation was 4.7%.

Table 3

The mean human IL-33 concentration and the coefficient of variation for each sample

Sample	Experiment	Mean Human IL-33 Concentration (pg/ml)	Coefficient of Variation (%)
1	1	131.89	3.4
	2	142.36	1.2
	3	141.34	2.5
2	1	64.37	4.0
	2	64.28	3.1
	3	71.24	3.5
3	1	29.71	1.3
	2	30.30	4.9
	3	32.68	6.1
4	1	13.37	9.5
	2	12.40	6.4
	3	13.21	6.5
5	1	123.94	5.0
	2	137.08	3.2
	3	144.29	5.6
6	1	65.01	6.5
	2	60.92	5.5
	3	73.34	5.0
7	1	28.04	1.6
	2	25.09	5.3
	3	30.19	4.2
8	1	11.18	7.5
	2	9.37	8.0
	3	11.00	3.1

13.2.2 Inter-assay

Assay to assay reproducibility within one laboratory was evaluated in 3 independent experiments. Each assay was carried out with 6 replicates of 8 serum samples containing different concentrations of human IL-33. 2 standard curves were run on each plate. Data below show the mean human IL-33 concentration and the coefficient of variation calculated on 18 determinations of each sample (see Table 4). The calculated overall inter-assay coefficient of variation was 6.9%.

Table 4

The mean human IL-33 concentration and the coefficient of variation of each sample

Sample	Mean Human IL-33 Concentration (pg/ml)	Coefficient of Variation (%)
1	138.53	4.2
2	66.63	6.0
3	30.89	5.1
4	13.00	4.0
5	135.11	7.6
6	66.42	9.5
7	27.77	9.2
8	10.52	9.5

13.3 Spike Recovery

The spike recovery was evaluated by spiking 3 levels of human IL-33 into serum, plasma and cell culture supernatant. Recoveries were determined with 4 replicates each. For recovery results see Table 5.

Table 5

Sample matrix	Spike high		Spike medium		Spike low	
	Range (%)	Mean (%)	Range (%)	Mean (%)	Range (%)	Range (%)
Serum	74 – 88	79	64 - 79	69	66 – 77	67
Plasma (citrate)	59 – 73	68	46 - 66	57	29 – 46	38
Plasma (heparin)	79 – 85	82	78 – 87	82	69 – 87	76
Cell culture supernatant		92		90		73

13.4 Dilution Parallelism

Serum, plasma and cell culture supernatant samples with different levels of human IL-33 were analysed at serial 2 fold dilutions with 4 replicates each.

The recovery ranged from 78% to 118% with an overall recovery of 99% (see Table 6).

For recovery data see Table 6.

Table 6

Sample matrix	Recovery of Exp. Val.	
	Range (%)	Mean (%)
Serum	92 - 118	101
Plasma (citrate)	91 - 111	99
Plasma (heparin)	78 - 99	89
Cell culture supernatant	106 - 107	107

13.5 Sample Stability

13.5.1 Freeze-Thaw Stability

Aliquots of serum samples were stored at -20°C and thawed 5 times, and the human IL-33 levels determined. There was no significant loss of human IL-33 immunoreactivity detected by freezing and thawing.

13.5.2 Storage Stability

Aliquots of serum samples were stored at -20°C, 2-8°C, room temperature (RT) and at 37°C, and the human IL-33 level determined after 24 h. There was no significant loss of human IL-33 immunoreactivity detected during storage at -20, 2-8°C and RT.

13.6 Specificity

The assay detects both natural and recombinant human IL-33. The cross reactivity and interference of circulating factors of the immune system was evaluated by spiking these proteins at physiologically relevant concentrations into a human IL-33 positive sample. There was no cross reactivity or interference detected, notably not with IL-1 α , IL-1 β and IL-18.

13.7 Expected Values

There were no detectable human IL-33 levels found. Elevated human IL-33 levels depend on the type of immunological disorder.

14 Ordering Information

North America

Technical Support:

Research Products:
888.810.6168
858.642.2058
tech@eBioscience.com

Clinical Products:
877.726.8559
858.642.2058
tech@eBioscience.com

Customer Service:

888.999.1371
858.642.2058
info@eBioscience.com

Fax:

858.642.2046

Europe/International*

Technical Support:

+43 1 796 40 40-120
tech@eBioscience.com

Customer Service:

+43 1 796 40 40-304
info@eBioscience.com

Fax:

+43 1 796 40 40-400



Bender MedSystems GmbH
Campus Vienna Biocenter 2
1030 Vienna, Austria
www.eBioscience.com

* Customers outside North America and Europe may contact their eBioscience distributor listed on our website at www.eBioscience.com/distributors.

15 Reagent Preparation Summary

15.1 Wash Buffer (1x)

Add **Wash Buffer Concentrate** 20x (50 ml) to 950 ml distilled water.

Number of Strips	Wash Buffer Concentrate (ml)	Distilled Water (ml)
1 - 6	25	475
1 - 12	50	950

15.2 Assay Buffer (1x)

Add **Assay Buffer Concentrate** 20x (5 ml) to 95 ml distilled water.

Number of Strips	Assay Buffer Concentrate (ml)	Distilled Water (ml)
1 - 6	2.5	47.5
1 - 12	5.0	95.0

15.3 Biotin-Conjugate

Make a 1:100 dilution of **Biotin-Conjugate** in Conjugate Diluent:

Number of Strips	Biotin-Conjugate (ml)	Conjugate Diluent (ml)
1 - 6	0.06	5.94
1 - 12	0.12	11.88

15.4 Streptavidin-HRP

Make a 1:100 dilution of **Streptavidin-HRP** in Assay Buffer (1x):

Number of Strips	Streptavidin-HRP (ml)	Assay Buffer (1x) (ml)
1 - 6	0.06	5.94
1 - 12	0.12	11.88

15.5 Human IL-33 Standard

Reconstitute lyophilized **human IL-33 standard** with Calibrator Diluent. (Reconstitution volume is stated on the label of the standard vial.)

16 Test Protocol Summary

1. Determine the number of microwell strips required.
2. Wash microwell strips twice with Wash Buffer.
3. Add 50µl Sample Diluent to all wells.
4. Add 50 µl of prepared Standard dilutions in duplicate to standard wells.
5. Add 50 µl Calibrator Diluent to blank wells.
6. Add 50 µl sample in duplicate to sample wells.
7. Cover microwell strips and incubate 2 hours at room temperature (18° to 25°C). (Shaking is absolutely necessary for an optimal test performance.)
8. Prepare Biotin-Conjugate.
9. Empty and wash microwell strips 6 times with Wash Buffer.
10. Add 100 µl Biotin-Conjugate to all wells.
11. Cover microwell strips and incubate 1 hour at room temperature (18° to 25°C). (Shaking is absolutely necessary for an optimal test performance.)
12. Prepare Streptavidin-HRP.
13. Empty and wash microwell strips 6 times with Wash Buffer.
14. Add 100 µl diluted Streptavidin-HRP to all wells.
15. Cover microwell strips and incubate 1 hour at room temperature (18° to 25°C). (Shaking is absolutely necessary for an optimal test performance.)
16. Empty and wash microwell strips 6 times with Wash Buffer.
17. Add 100 µl of TMB Substrate Solution to all wells.
18. Incubate the microwell strips for about 30 minutes at room temperature (18° to 25°C).
19. Add 100 µl Stop Solution to all wells.
20. Blank microwell reader and measure colour intensity at 450 nm.